

Repair Parts for Xtreme™ and XP Xtreme 250cc Lower

406893J

EN



Important Safety Instructions

Read all warnings and instructions in manual 311762. Save those instructions.

25D237 Full Repair Kit - Graco Formulated UHMWPE/Leather (Abrasive Applications)

25D247 Full Repair Kit - PTFE
Chemical Resistance and Higher Temperatures

25D261 Full Repair Kit - Graco Formulated UHMWPE/PTFE - Chemical Resistance and Durability Below 140° F (60° C)

Bulk Pack Replacement Parts

- 1 Torque to 190-210 ft-lb (258-285 N•m).
- 2 Torque to 125 ft-lb (169 N•m).
- 3 Torque to 135-150 ft-lbs (183-203 N•m).
- 4 Torque to 40-60 ft-lb (52-82 N•m).
- 5 Apply lubricant to threads before assembly.
- 6 Lubricate.
- 7 Circular grooves on top filter caps (not included) indicates pump series. See page 3 for detailed information.
- 8. Thick, medium, and thin refers to the relative cross-section thickness of the o-rings.



Non-filter models do not use items 122, 125, and 159.

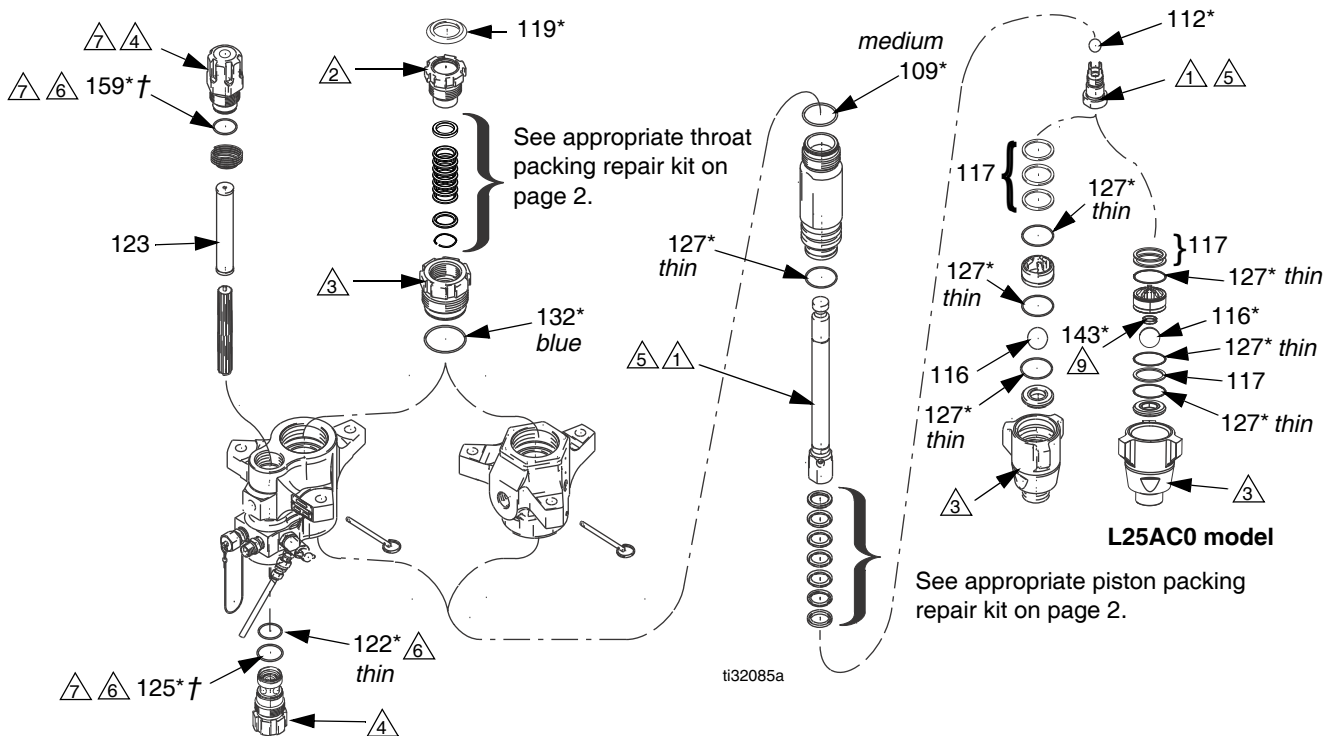

Bulk Pack Replacement Parts

Ref.	Part	Description	Qty.
103*	---	THROAT PACKINGS	1
104*	---	PISTON PACKINGS	1
109*	244893	O-RING, PTFE, top cylinder; medium (10/pack)	1
112*	244898	BALL, piston, 7/8 in. (22 mm) diameter (3/pack)	1
116*	253030	BALL, inlet, 1-1/2 in. (38 mm) diameter (3/pack)	1
117	244856	SHIM, inlet, ball guide (9/pack)	3
119*	244999	PLUG, throat seal (10/pack)	1
	247395	PLUG, throat seal (10/pack)	1
122*	244895	O-RING, filter; thin, PTFE (10/pack)	1
123	238436	STRAINER, 30 mesh screen, 5.65 in. (143.5 mm) (25/pack)	1
123	244458	STRAINER, 30 mesh screen, 5.65 in. (143.5 mm) (2/pack)	1
123	238438	STRAINER, 60 mesh screen, 5.65 in. (143.5 mm) (25/pack)	1
123	224459	STRAINER, 60 mesh screen, 5.65 in. (143.5 mm) (2/pack)	1
125* †	262484	O-RING, bottom cap (10/pack)	1
	244896	For Series A pumps (10/pack)	1
127*	244894	O-RING, PTFE; thin (10/pack)	4
132*	244891	O-RING, blue, thin (10/pack)	1
143*	116802	SPRING, foot valve; 262794 only	1
159* †	262483	O-RING, top cap (10 pack)	1
	244895	For Series A pumps (10/pack)	1

* Included in Seal Repair Kits.

† See page 3 to match correct o-ring with pump series. Discard unused o-rings; they do not fit different series pumps.

Thick, medium, and thin refers to the relative cross-section thickness of the o-rings.

NOTE: The L25AC0 model uses a 30 mesh filter.

Full Repair Kit - PTFE - 25D247

(*Includes item shown in Replacement Parts table.
NOTE: Throat and Piston Packings are the same.)

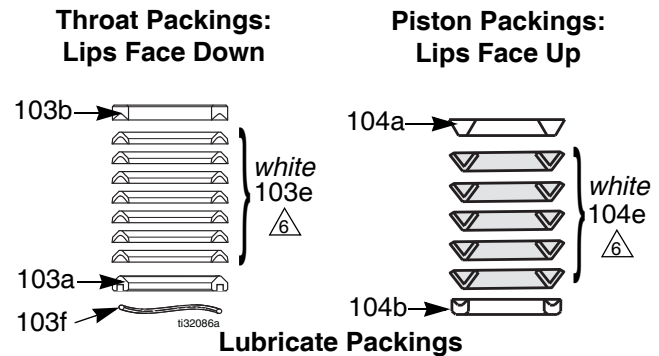

Throat Seal Repair Kit - PTFE - 25D154

Includes:

Ref.	Description	Qty.
103a	GLAND, male throat	1
103b	GLAND, female, throat	1
103e	V-PACKING, PTFE, throat (white)	7
103f	WAVE SPRING	1

Piston Seal Repair Kit - PTFE - 25D164

Includes:

Ref.	Description	Qty.
104a	GLAND, male, piston	1
104b	GLAND, female, piston	1
104e	V-PACKING, PTFE, piston (white)	5

**Full Repair Kit - Graco Formulated
UHMWPE/Leather - 25D237**

(*Includes items shown in Replacement Parts table.
NOTE: Throat and Piston Packings are the same.)

Throat Packings:

**Piston Packings:
Lips Face Up**

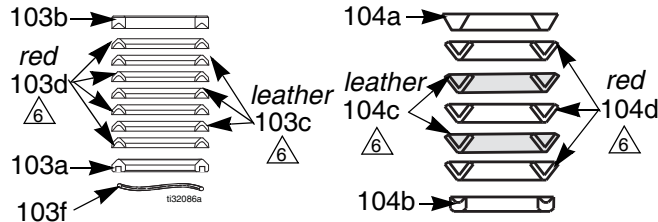

Lubricate Packings

(soak leather packings in oil for 1 hour)

**Full Repair Kit - Graco Formulated
UHMWPE/PTFE - 25D261**

(*Includes items shown in Replacement Parts table.
NOTE: Throat and Piston Packings are the same.)

**Throat Packings:
Lips Face Down**

**Piston Packings:
Lips Face Up**

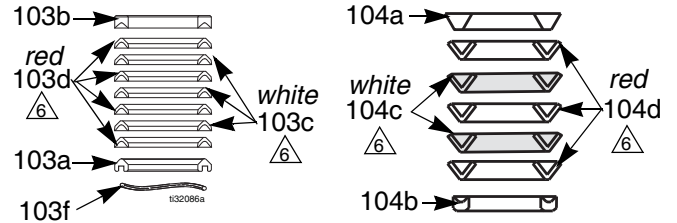

Lubricate Packings

**Throat Seal Repair Kit - Graco Formulated
UHMWPE/Leather - 25D137**

Includes:

Ref.	Description	Qty.
103a	GLAND, male, throat	1
103b	GLAND, female, throat	1
103c	V-PACKING, leather, throat	3
103d	V-PACKING, UHMWPE, throat (red)	4
103f	WAVE SPRING	1

**Piston Seal Repair Kit - Graco Formulated
UHMWPE/Leather - 25D144**

Includes:

Ref.	Description	Qty.
104a	GLAND, male, piston	1
104b	GLAND, female, piston	1
104c	V-PACKING, leather, piston	2
104d	V-PACKING, UHMWPE, piston (red)	3

**Throat Seal Repair Kit - Graco Formulated
UHMWPE/PTFE - 25D178**

Includes:

Ref.	Description	Qty.
103a	GLAND, male, throat	1
103b	GLAND, female, throat	1
103c	V-PACKING, PTFE, throat (white)	3
103d	V-PACKING, UHMWPE, throat (red)	4
103f	WAVE SPRING	1

**Piston Seal Repair Kit - Graco Formulated
UHMWPE - 25D192**

Includes:

Ref.	Description	Qty.
104a	GLAND, male, piston	1
104b	GLAND, female, piston	1
104c	V-PACKING, PTFE, piston (white)	2
104d	V-PACKING - UHMWPE, piston (red)	3

O-ring Chart

The pump series for all Xtreme and XP lowers are identified by the circular grooves on the top filter cap. Use the chart below to match the correct o-rings when rebuilding the pump.

The original filter cap seals were changed in 2010 for improved sealing. The o-rings are not interchangeable between different series filter caps. See **24F975 Filter Cap Conversion Kit**, page 4.

Note: The top filter cap is shown (not included in the repair kit). O-rings below are shown at actual size.

Series A

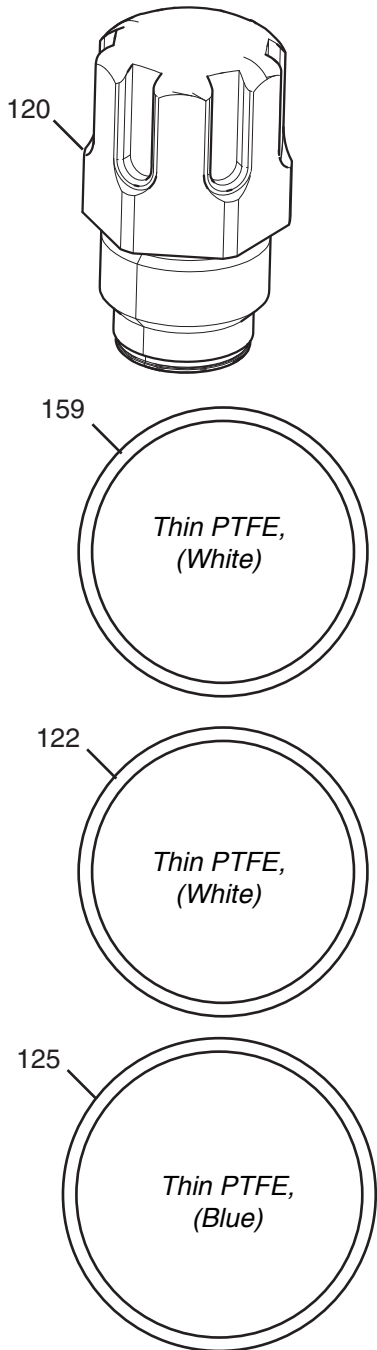

Series B

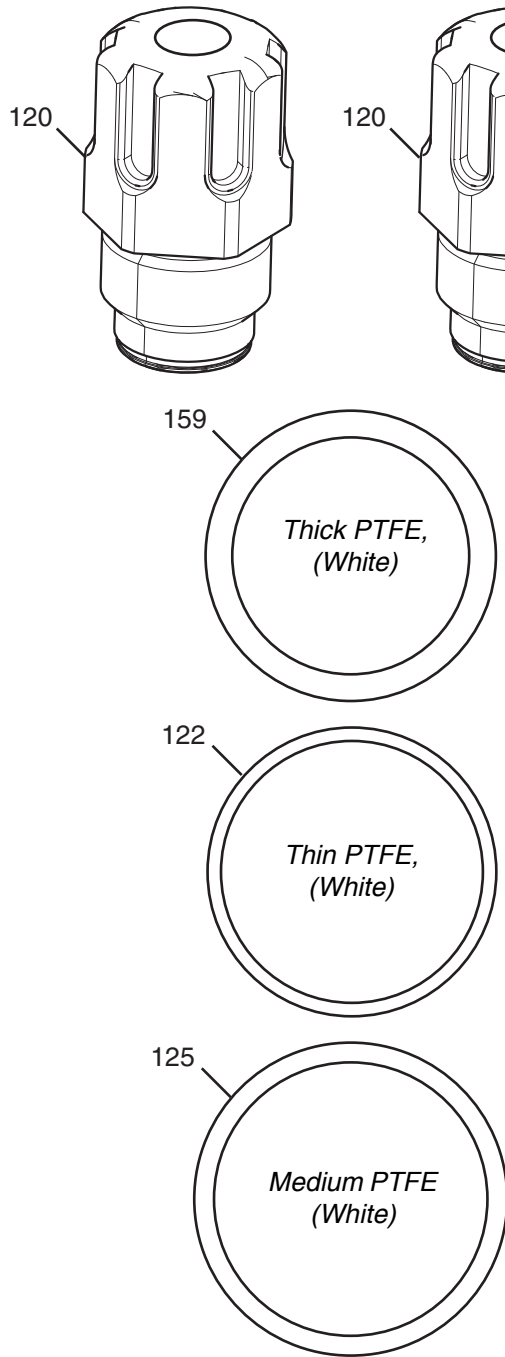

Series C

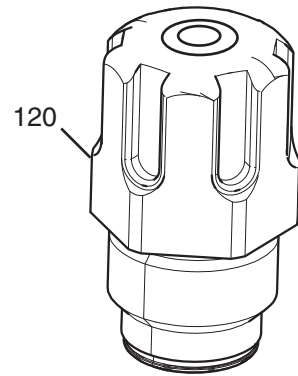

1 in.
(25.4 mm)

24F975 Filter Cap Conversion Kit

Purchase **24F975 Filter Cap Conversion Kit** to improve sealing of Series A filters. Includes components shown. See manual 406882 for more information.

Benefits:

- Compatible with all sizes.
- Improves sealing
- Ensures filters are installed correctly

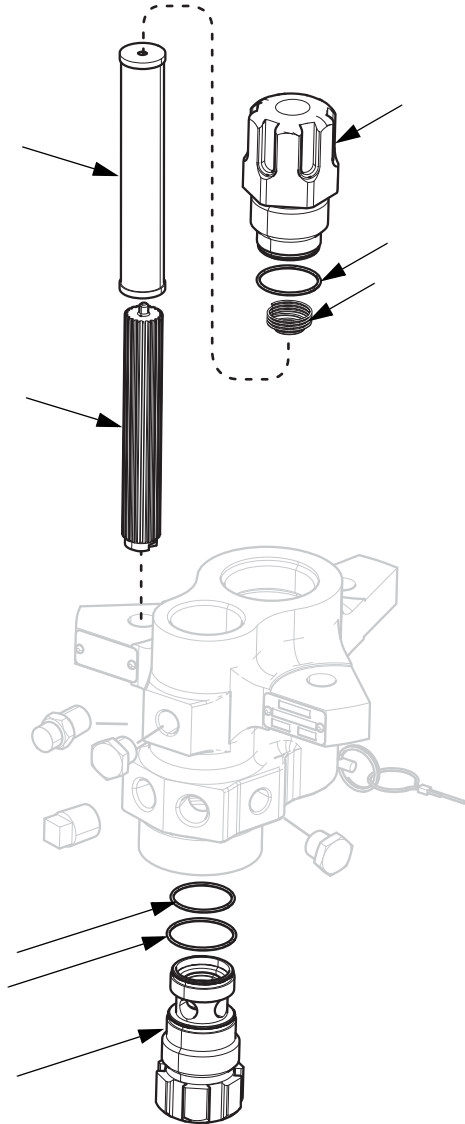

*All written and visual data contained in this document reflects the latest product information available at the time of publication.
Graco reserves the right to make changes at any time without notice.*

For patent information, see www.graco.com/patents.

Original instructions. This manual contains English. MM 406893

Graco Headquarters: Minneapolis

International Offices: Belgium, China, Japan, Korea

GRACO INC. AND SUBSIDIARIES • P.O. BOX 1441 • MINNEAPOLIS MN 55440-1441 • USA
Copyright 2010, Graco Inc. All Graco manufacturing locations are registered to ISO 9001.

www.graco.com

Revision J, September 2018