

Cordless HandHeld Airless Sprayers

3A4749E

EN

Project Series Paint Sprayers



Important Safety Instructions

Read all warnings and instructions in this manual, and in related manuals, before using the equipment. Be familiar with the controls and the proper usage of the equipment. Save these instructions.



Important Medical Information

Read the medical alert card provided with the gun. It contains injection injury treatment information for a doctor. Keep it with you when operating the equipment.

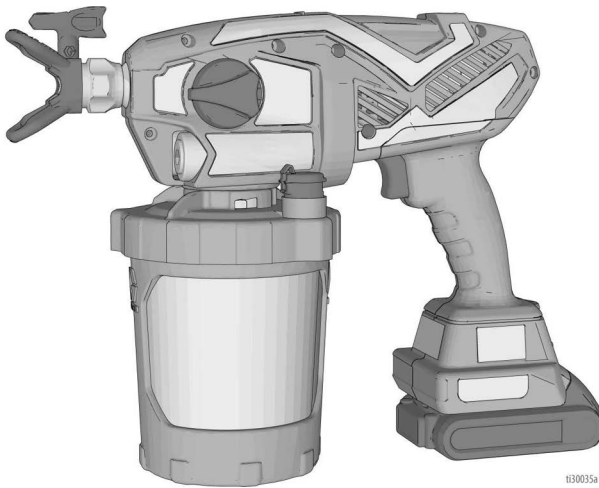

t330035a



Additional Manual
Languages

	Questions?	
	844-241-9499	
<small>to every customer, every time</small>	www.graco.com/techsupport	

POWERED BY

***For portable spray applications of water-based architectural paints and coatings only.
Not approved for use in explosive atmospheres or hazardous (classified) locations.***





Before You Spray

Before You Spray

Review Warnings for Important Safety Information

Important! Read carefully and practice good safety habits.

Models

	Model	Sprayer Name	Charger Voltage	Tip Family	Tip Size
 Intertek 110474 Certified to CAN/CSA C22.2 No. 68 Conforms to UL 1450	17M363	Ultra	120V	FFLPxxx	0.008 – 0.016 in. (0.20 – 0.41 mm)
	17P515		*		
	17N164	Ultimate	120V		
	17P516		*		
	17N165	TC Pro	120V	TCPxxx	
	17N166				
	17P518		*		
	17N167	Ultra	100V	FFLPxxx	
	17N220	Ultra	230V		
	17M366	Ultra	230V		
	17M364	Ultra			
	17N221	Ultra	230V		

* Tool only, without battery and charger.

Operating pressure range: 500 – 2000 psi (35 – 138 bar, 3.5 MPa – 14 MPa)

Compatible with the following DeWALT batteries: DCB183 and DCB203

Operational video

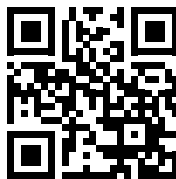

<http://graco.com/hhsupport>

Related Manuals

Manual in English	Description
	DeWALT charger manual

Important User Information

Thank You for Your Purchase!

Congratulations! You have purchased a high-quality paint sprayer made by Graco Inc. This sprayer is designed to provide superior spray performance with water-based and oil-based (mineral spirit-type) architectural paints and coatings. This user information is intended to help you understand the types of materials that can be used with your sprayer.

Please read the information on the material container label to determine if it can be used with your sprayer. Ask for a Safety Data Sheet (SDS) from your supplier. The container label and SDS will explain the contents of the material and the specific precautions related to it.

Paints, coatings and clean-up materials generally fit into one of the following **2 basic categories**:



WATER-BASED: The container label should indicate that the material can be cleaned up with soap and water. Your sprayer is compatible with this type of material. Your sprayer is **NOT** compatible with harsh cleaners such as chlorine bleach.



FLAMMABLE: This type of material contains flammable solvents such as xylene, toluene, naphtha, MEK, lacquer thinner, acetone, denatured alcohol, and turpentine. The container label should indicate that this material is **FLAMMABLE**. This type of material is **NOT** compatible with your sprayer and **CANNOT** be used.

NOTICE

Your sprayer is **NOT** compatible with harsh cleaners such as chlorine bleach. Using these cleaners will cause damage to the sprayer.

Contents

Before You Spray	2
Related Manuals	2
Important User Information	3
Contents	4
Warnings	5
Know Your Sprayer	8
Know Your Controls	9
Setup	10
Pressure Relief Procedure	10
Sprayer Setup	10
Startup	13
Spraying	15
Tip and Pressure Selection	15
Spray Tip Orientation	16
Spray Pattern Quality	16
Spray Angle	16
Aiming Sprayer	17
Triggering Timing	17
Reversible Spray Tips	17
Clear Tip Clogs	18
Spray Tip Installation	19
Cup Refills	20
Pause in Spraying	20
Cleanup	21
Cleaning Sprayer	21
Storage	23
Reference	24
Cleaning Fluid Compatibility	24
Maintenance	25
Cleaning Outlet Valves	25
Recycling and Disposal	26
End of Product Life	26
End of Life Disposal	26
Troubleshooting	27
Replacement Parts	32
Parts List	33
Technical Specifications	35
Graco Standard Warranty	36

Warnings

The following warnings are for the setup, use, grounding, maintenance, and repair of this equipment. The exclamation point symbol alerts you to a general warning and the hazard symbols refer to procedure-specific risks. When these symbols appear in the body of this manual or on warning labels, refer back to these Warnings. Product-specific hazard symbols and warnings not covered in this section may appear throughout the body of this manual where applicable.

WARNING



FIRE AND EXPLOSION HAZARD

Flammable fumes, such as solvent and paint fumes, in work area can ignite or explode. To help prevent fire and explosion:



- Do not spray or clean with materials having flash points lower than 100°F (38°C). Use only non-flammable or water-based materials, or non-flammable paint thinners. For complete information about your material, request the Safety Data Sheets (SDSs) from the material distributor or retailer.



- Do not spray combustible materials near an open flame or sources of ignition such as cigarettes, motors, and electrical equipment.



- Paint or solvent flowing through the equipment is able to result in static electricity. Static electricity creates a risk of fire or explosion in the presence of paint or solvent fumes. All parts of the spray system, including the sprayer and objects in and around the spray area shall be properly grounded to protect against static discharge and sparks.



- Verify that all containers and collection systems are grounded to prevent static discharge. Do not use pail liners unless they are anti-static or conductive.
- **Stop operation immediately** if static sparking occurs or you feel a static charge. Do not use equipment until you identify and correct the problem.
- Do not use a paint or a solvent containing halogenated hydrocarbons.
- Keep spray area well-ventilated. Keep a good supply of fresh air moving through the area.
- Sprayer generates sparks. Keep pump assembly in a well-ventilated when spraying, flushing, cleaning, or servicing.
- Do not smoke in the spray area or spray where sparks or flame is present.
- Do not operate light switches, engines, or similar spark producing products in the spray area.
- Keep area clean and free of paint or solvent containers, rags, and other flammable materials.
- Know the contents of the paints and solvents being sprayed. Read all Safety Data Sheets (SDSs) and container labels provided with the paints and solvents. Follow the paint and solvent manufacturer's safety instructions.
- Keep a working fire extinguisher in the work area.

Warnings

WARNING



BATTERY AND CHARGER COMPATIBILITY HAZARD

- Only use DEWALT brand 18V Max or 20V Max batteries and battery chargers with this tool.
- READ ALL INSTRUCTIONS included with this tool regarding the safety and usage of DEWALT batteries and battery chargers.
- Do not wash or spray down battery.
- Do not clean the battery with anything other than a cloth moistened with water.



SKIN INJECTION HAZARD

High-pressure spray is able to inject toxins into the body and cause serious bodily injury. In the event that injection occurs, **get immediate surgical treatment.**



- Do not aim the gun at, or spray any person or animal.
- Keep hands and other body parts away from the discharge. For example, do not try to stop leaks with any part of the body.
- Always use the spray tip guard. Do not spray without spray tip guard in place.
- Use Graco spray tips.
- Use caution when cleaning and changing spray tips. In the case where the spray tip clogs while spraying, follow the **Pressure Relief Procedure** for turning off the unit and relieving the pressure before removing the spray tip to clean.
- Do not leave the equipment energized or under pressure while unattended. Remove battery and follow the **Pressure Relief Procedure** when the equipment is unattended or not in use, and before servicing, cleaning, or removing parts.
- Check parts for signs of damage. Replace any damaged parts.
- This system is capable of producing 2000 psi (138 bar, 14 MPa). Use Graco replacement parts or accessories that are rated a minimum of 2000 psi (138 bar, 14 MPa).
- Verify that all connections are secure before operating the unit.
- Know how to stop the unit and bleed pressure quickly. Be thoroughly familiar with the controls.



EQUIPMENT MISUSE HAZARD

Misuse can cause death or serious injury.



- Always wear appropriate gloves, eye protection, and a respirator or mask when painting.
- Do not operate or spray near children. Keep children away from equipment at all times.
- Do not overreach or stand on an unstable support. Keep effective footing and balance at all times.
- Stay alert and watch what you are doing.
- Do not operate the unit when fatigued or under the influence of drugs or alcohol.
- Do not alter or modify equipment. Alterations or modifications may void agency approvals and create safety hazards.
- Use only in dry locations. Do not expose to water or rain.
- Use in well-lit areas.
- Make sure all equipment is rated and approved for the environment in which you are using it.

WARNING



PRESSURIZED ALUMINUM PARTS HAZARD

Use of fluids that are incompatible with aluminum in pressurized equipment can cause serious chemical reaction and equipment rupture. Failure to follow this warning can result in death, serious injury, or property damage.

- Do not use 1,1,1-trichloroethane, methylene chloride, other halogenated hydrocarbon solvents or fluids containing such solvents.
- Do not use chlorine bleach.
- Many other fluids may contain chemicals that can react with aluminum. Contact your material supplier for compatibility.



TOXIC FLUID OR FUMES HAZARD

Toxic fluids or fumes can cause serious injury or death if splashed in the eyes or on skin, inhaled, or swallowed.

- Read Safety Data Sheets (SDSs) to know the specific hazards of the fluids you are using.
- Store hazardous fluid in approved containers, and dispose of it according to applicable guidelines.



PERSONAL PROTECTIVE EQUIPMENT

Wear appropriate protective equipment when in the work area to help prevent serious injury, including eye injury, hearing loss, inhalation of toxic fumes, and burns. Protective equipment includes but is not limited to:

- Protective eyewear, and hearing protection.
- Respirators, protective clothing, and gloves as recommended by the fluid and solvent manufacturer.

Know Your Sprayer

Know Your Sprayer

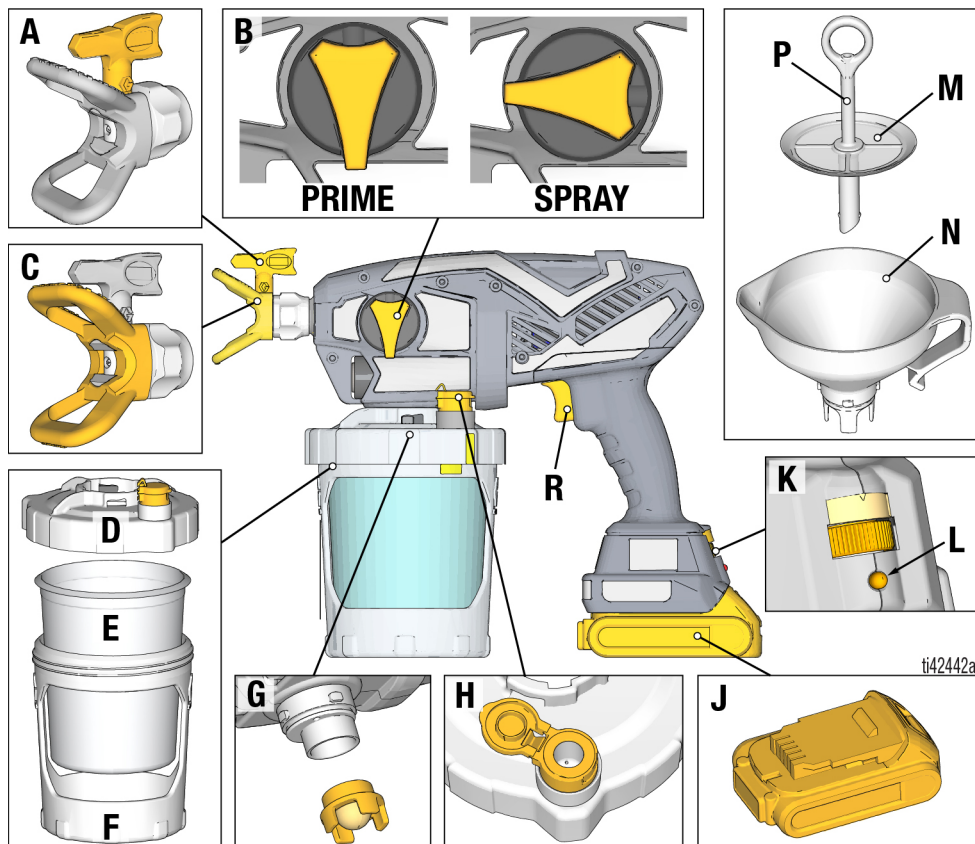

ti42442a

A	Spray Tip
B	Prime Knob
C	Spray Tip Guard
D	Cup Lid
E	FlexLiner™
F	Cup Support
G	Pump Filter

H	VacuValve™
J	Battery
K	Speed Control
L	Diagnostic Light
M	Strainer
N	Funnel
P	Strainer's Air Tube
R	Trigger

Know Your Controls

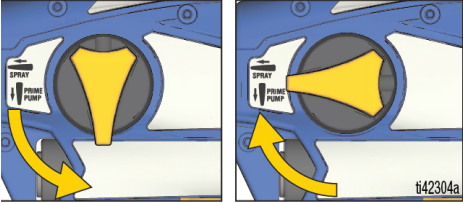
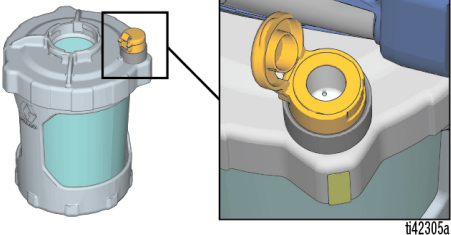
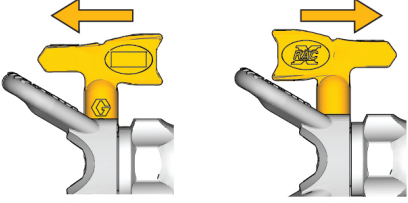
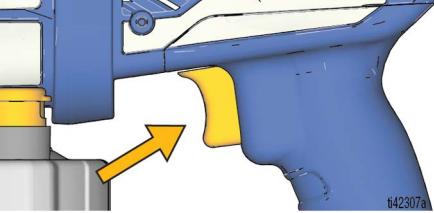
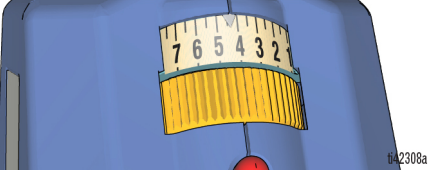
	<p>Prime Knob</p> <p>The Prime Knob directs fluid to either the cup or the Spray Tip. When priming, it is used to purge air from the pump. Your sprayer will not spray with air in the pump.</p> <p>Turn Prime Knob down to PRIME position when priming the sprayer or to relieve system pressure.</p> <p>Turn Prime Knob forward to SPRAY position to spray fluid.</p>
	<p>VacuValve</p> <p>The VacuValve is used to evacuate air out of the FlexLiner. This is necessary for the sprayer to prime.</p>
	<p>Spray Tip</p> <p>The Spray Tip is the key to airless spray technology. High pressure paint pumped through the very small hole in the Spray Tip comes out as a spray.</p> <p>The Spray Tip has the ability to be reversed and quickly clear clogs.</p>
	<p>Trigger</p> <p>The Trigger controls the operation of the sprayer.</p>
	<p>Speed Control</p> <p>The Speed Control allows you to slow down or speed up when spraying.</p>

Setup

Setup

Pressure Relief Procedure



This sprayer builds up an internal pressure of 2000 psi (138 bar, 13.8 MPa) during use. Follow this **Pressure Relief Procedure** whenever you stop spraying and before cleaning, checking, servicing, or transporting equipment to prevent serious injury from pressurized fluid.

1. Turn Prime Knob down to PRIME position to relieve pressure.



Sprayer Setup



Use only water-based materials. Do not use materials which state “FLAMMABLE” on the packaging. For more information about your material, request a Safety Data Sheet (SDS) from distributor or retailer.

Keep spray area well-ventilated. Keep a good supply of fresh air moving through the area.

NOTE: Do NOT shake materials to be used with this sprayer. Some fine finish lacquers and enamels trap air when shaken, which can affect sprayer performance. Stir the material or check the manufacturer’s recommendation for the material being sprayed.

1. Insert one FlexLiner into the Cup Support.

NOTE: Verify there is no damage to the top sealing edge of the FlexLiner, such as a crease or fold. If damaged it will leak air and lose prime.

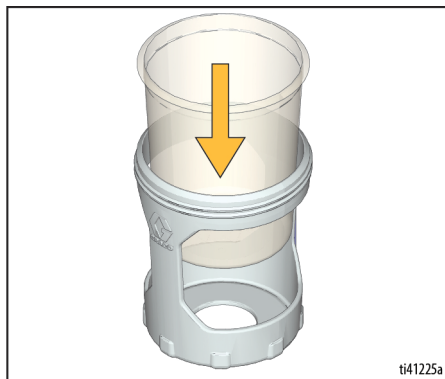

2. Firmly tighten the Cup Lid onto the Cup Support to ensure an airtight seal.

NOTE: To ensure an airtight seal, the gasket inside the Cup Lid is lubricated by the factory. If lubrication has washed away, apply Seal Lube (included) to the gasket.

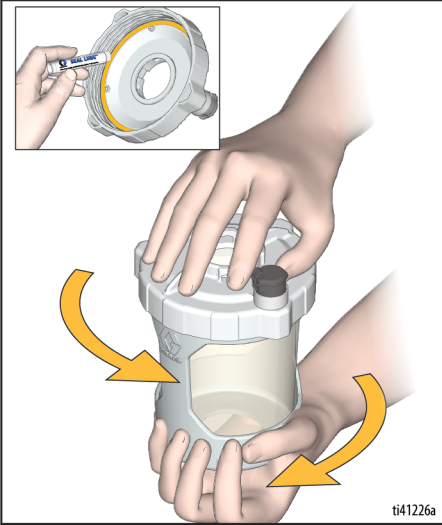

3. Insert the Funnel into the Cup Lid, twist to lock. Snap the Strainer into the Funnel to strain your paint as you fill your cup.

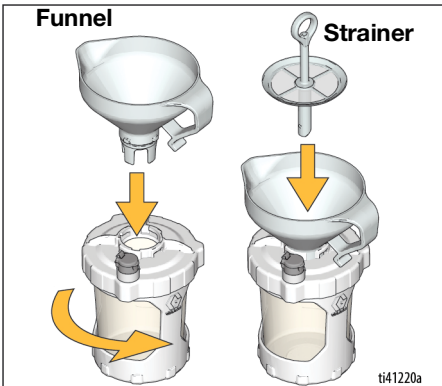

4. The Strainer's Air Tube will prevent paint from overflowing the cup. Fill the cup as follows:

- a. Watching the Funnel (not the cup), slowly pour paint into the Funnel. When the paint stops draining down, the cup is full.

NOTE: If the paint stops draining but you see the cup is not full, use a stir stick to scrape the captured debris on the top of the Strainer until the paint resumes draining.



- b. With the Funnel and Strainer still attached to the cup, pour excess paint from the Funnel back into the paint can.

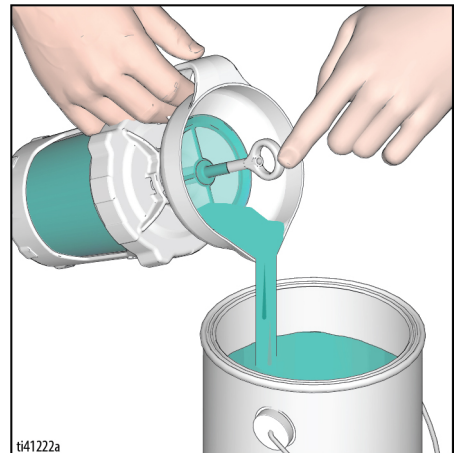

Setup

- c. Lift up the Strainer and look to verify you can see *crossbars* in the bottom of the Funnel. If not, the cup is overfilled. Pour excess paint back into the paint can.

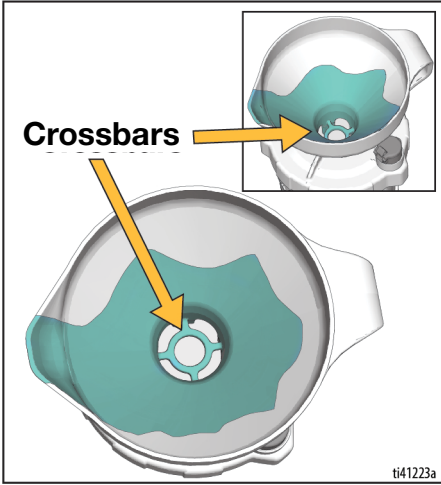

- d. Remove the Funnel and Strainer from the cup and hook on edge of paint can.

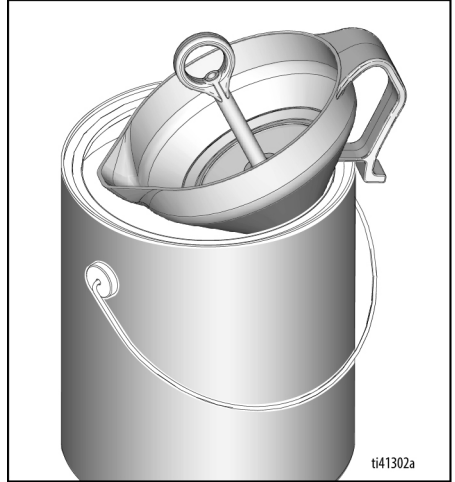

Startup

Always start with a fully charged Battery. See Battery and charger information shipped with the sprayer.

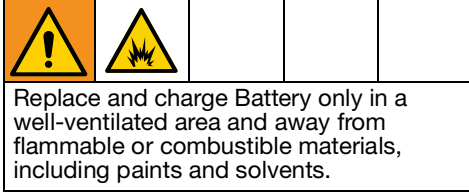

1. Install the cup onto the sprayer as follows:
 - a. Verify Pump Filter is installed and clean.

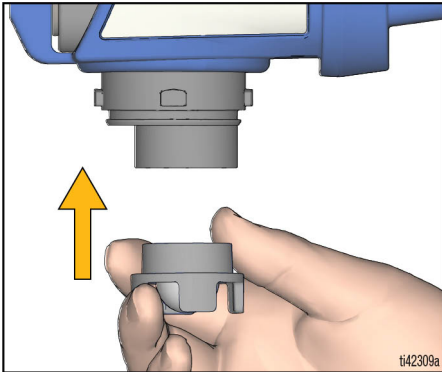

- b. Align VacuValve (on Cup Lid) with Prime Knob (on sprayer).
 - c. Push cup assembly onto the sprayer, twist to lock.

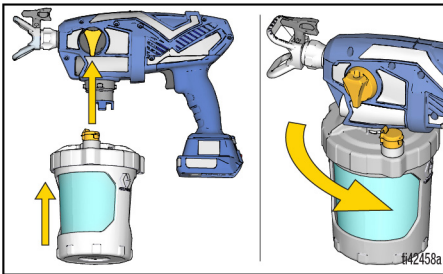

2. Prime the pump as follows:
 - a. Verify Prime Knob is pointed down to PRIME position.



- b. Install Battery onto sprayer.

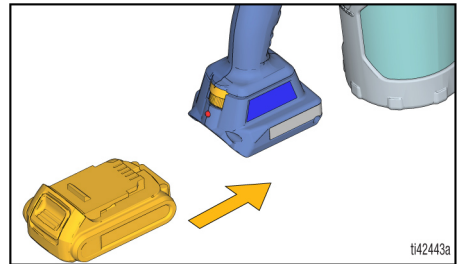

- c. Open the VacuValve cap and gently squeeze the FlexLiner until no more air bubbles appear in the VacuValve.

NOTE: Tilt the sprayer such that the VacuValve is the highest point so that all air in the FlexLiner can be fully evacuated.

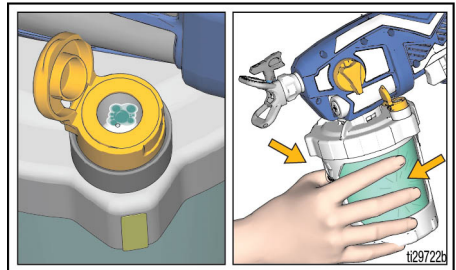

Startup

- d. Continue to squeeze the FlexLiner while pulling the Trigger for 10 seconds.

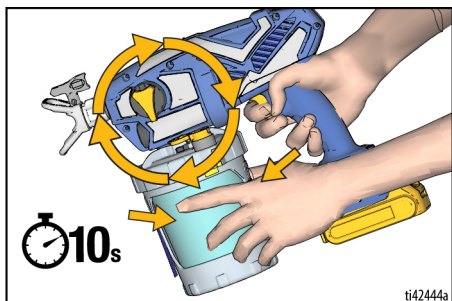

NOTE: This will purge all air from the pump and cup. Paint will not spray out, but will recirculate through the pump and back into the cup.

- e. When no more air bubbles appear in the VacuValve, release the Trigger and close the VacuValve cap.

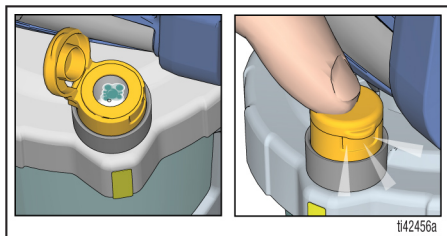

3. Turn Prime Knob forward to SPRAY position. Verify Spray Tip is forward in the SPRAY position.

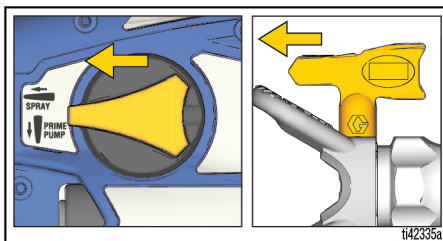

4. Point the sprayer into a waste pail and pull the Trigger for 5 seconds to spray out storage fluid.
 - To avoid pump damage, if the sprayer does not spray after 5 seconds, STOP and repeat STARTUP.

You are now ready to spray!

NOTE: For best results, to evacuate all material from the FlexLiner when the material is nearly gone, gently squeeze the bottom of the FlexLiner to push the last of the material up to the Cup Lid.

IMPORTANT! The motor has a built-in feature to protect itself from overuse. If the motor stops, the thermal switch has tripped. The motor will operate normally after cooling for 20-30 minutes.

Spraying



Use only water-based materials. Do not use materials which state “FLAMMABLE” on the packaging. For more information about your material, request a Safety Data Sheet (SDS) from distributor or retailer.

Keep spray area well-ventilated. Keep a good supply of fresh air moving through the area.

1. Set the Speed Control to lowest available setting.

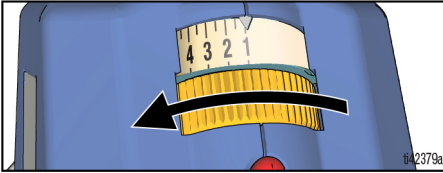

2. Pointing at a piece of scrap cardboard, pull the Trigger to test the spray pattern.
3. If needed, slowly increase the Speed Control to the setting that produces a good spray pattern.

NOTE: To minimize overspray, always spray at the lowest speed setting that gives a good spray pattern.

4. Adjust the sprayer’s distance from the surface and your hand speed to achieve the desired surface coverage.

NOTE: For proper sprayer operation use only a tip from the same tip family that came with your sprayer.

Sprayer Name	Tip Family	Tip Part No.
Ultra	FFLP	FFLPxxx
Ultimate	FFLP	FFLPxxx
TC Pro	TCP	TCPxxx

Tip and Pressure Selection

See table for recommended spray pressure for your material. Refer to paint (material) can for manufacturer’s recommendations.

	Coatings						
	Interior Stains/ Interior & Exterior Clears	Exterior Solid Stains	Primers	Enamels	Interior Latex Paints	Exterior Latex Paints	Filter Color
Speed Control	1 – 5	6 – 10	6 – 10	6 – 10	6 – 10	6 – 10	
Tip hole Size							
0.008 in. (0.20 mm)	✓						Blue
0.010 in. (0.25 mm)	✓	✓					Blue
0.012 in. (0.30 mm)		✓		✓			Blue
0.014 in. (0.36 mm)		✓	✓	✓	✓		Black
0.016 in. (0.41 mm)		✓	✓	✓	✓	✓	Black

Spraying

Spray Tip Orientation

To avoid serious injury from skin injection, do not put your hand in front of the Spray Tip or Spray Tip Guard.				

NO

YES

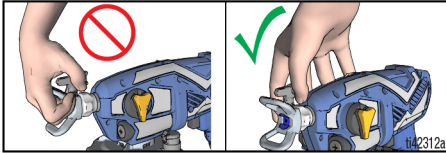

Adjust the Spray Tip Guard for the desired vertical or horizontal spraying direction.

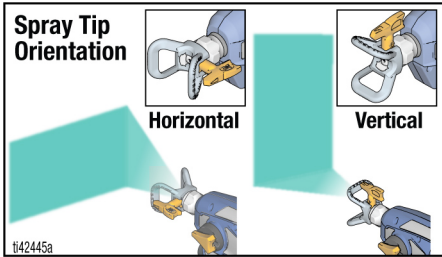

Spray Pattern Quality

A good spray pattern is evenly distributed without voids or runs. Adjust sprayer Speed Control, hand speed, and distance from the wall to get a good spray pattern.

If tails persist, material may need to be thinned. If material needs to be thinned, follow manufacturers recommendations.

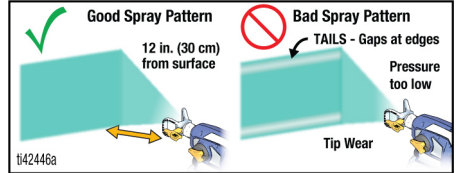

Spray Angle

Use a piece of scrap cardboard to practice these basic spraying techniques before you begin spraying the surface.

- Hold sprayer 10-12 inches (25-30 cm) from surface and aim straight at surface. Tilting the sprayer to direct the spray angle causes an uneven finish.

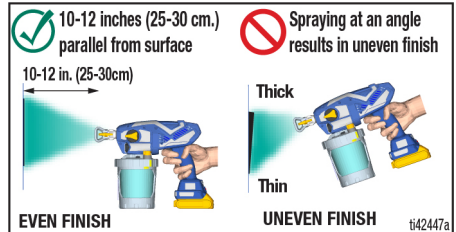

- Flex wrist to keep sprayer pointed straight. Fanning sprayer to direct spray at angle causes uneven finish.

NOTE: How fast you move the sprayer will affect spray application. If material is pulsating, you are moving too fast. If material drips, you are moving too slow. See **Troubleshooting**, page 27.

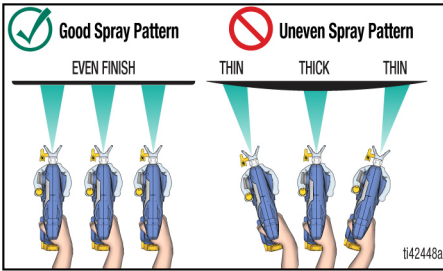

Aiming Sprayer

Aim the sprayer at the bottom edge of the previous stroke, overlapping each stroke by 50%.

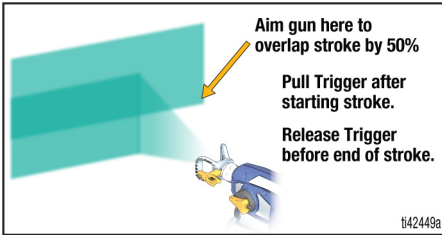

Triggering Timing

Pull Trigger after starting stroke. Release Trigger before end of stroke. Sprayer must be moving when Trigger is pulled and released.

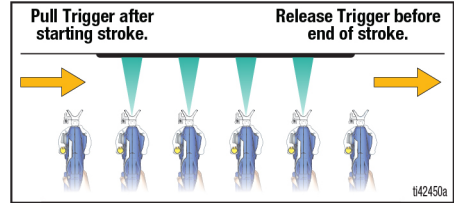

Reversible Spray Tips

Your sprayer is compatible with wide and narrow reversible Spray Tips.

- *0.014 & Larger* Spray Tips are for spraying *paint* and should be used with the black Pump Filter.
- *0.012 & Smaller* Spray Tips are for spraying *stain* and should be used with the blue Pump Filter.

Not all tips and filters are included with all models.

Spraying

Clear Tip Clogs



To avoid serious injury from skin injection, do not put your hand in front of the Spray Tip or Spray Tip Guard.

In the event debris clogs the Spray Tip, the sprayer is designed with a reversible Spray Tip that quickly and easily clears the particles without disassembling the sprayer.

1. Perform **Pressure Relief Procedure**, page 10.
2. Reverse Spray Tip to **UNCLOG** position.

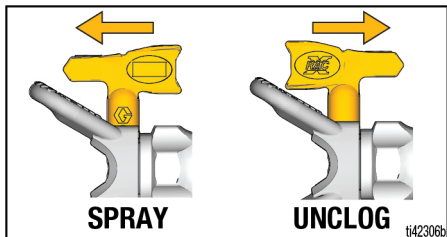

3. Set Speed Control to highest setting.

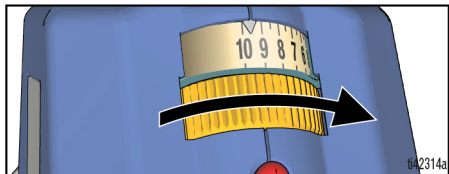

4. Point sprayer into waste pail, turn Prime Knob forward to **SPRAY** position. Pull Trigger for 5 seconds to clear clog.

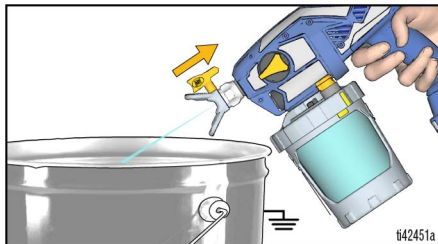

NOTE: If Spray Tip is still clogged, you may have to repeat steps 1-4, or replace with replacement Spray Tip.

5. Turn Prime Knob downward to **PRIME** position. Rotate Spray Tip back to **SPRAY** position. Turn Prime Knob forward to **SPRAY** position, and resume spraying.

Spray Tip Installation



To avoid serious injury from skin injection do not put your hand in front of the Spray Tip when installing or removing the Spray Tip and Spray Tip Guard.

To prevent Spray Tip leaks make certain Spray Tip and Spray Tip Guard are installed properly.

1. Perform **Pressure Relief Procedure**, page 10.
2. Remove the Battery.
3. Use Spray Tip (A) to insert seal (B) into Spray Tip Guard (C).

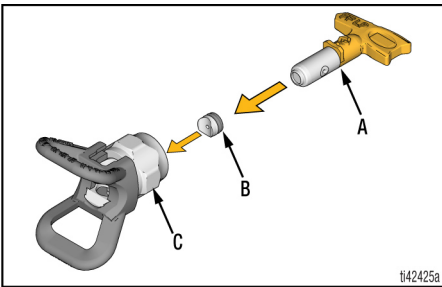

4. Insert Spray Tip. Spray Tip must be pushed all the way into the Spray Tip Guard.

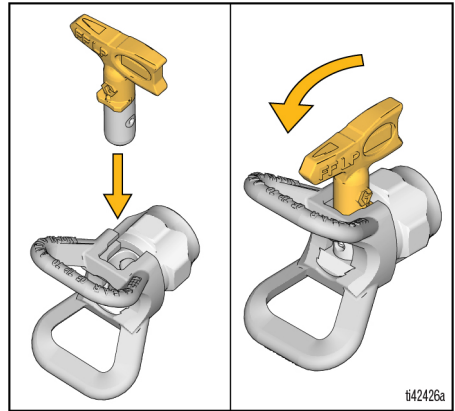

5. Screw Spray Tip Guard assembly onto the sprayer and hand tighten.
 - Spray Tips wear with use and abrasive paint and need periodic replacement.
 - If the spray pattern is poor, you may have a worn Spray Tip. Replace Spray Tip. See **Spray Pattern Diagnostics**, page 30.

NOTICE

Spray Tips must be cleaned or stored in appropriate cleaning fluid (water or mineral spirits) immediately after use to ensure material is not allowed to dry in Spray Tip. Failure to do so will result in damage to the Spray Tip. See **Cleanup**, page 21.

Spraying

Cup Refills



Use only water-based materials. Do not use materials which state “FLAMMABLE” on the packaging. For more information about your material, request a Safety Data Sheet (SDS) from distributor or retailer.

Keep spray area well-ventilated. Keep a good supply of fresh air moving through the area.

1. Perform **Pressure Relief Procedure**, page 10.
2. Remove cup assembly from sprayer. Remove the Pump Filter and clean debris from the filter screen.

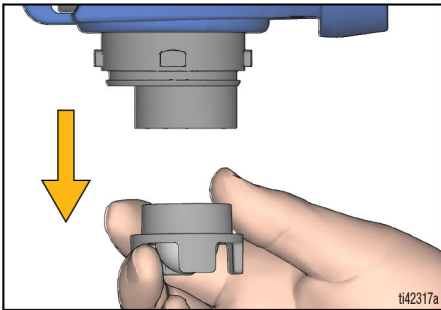

3. Reinstall the Pump Filter into the pump. Set sprayer on a rag.

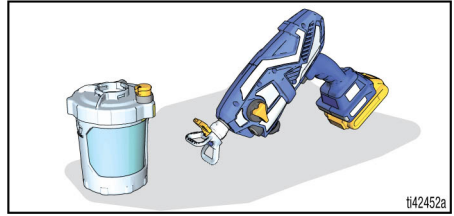

4. Refill the cup following **Sprayer Setup**, page 10, steps 3 and 4. Then follow **Startup**, page 13, to proceed.

Pause in Spraying

Paint will dry quickly and cause clogs in the sprayer. Follow these steps whenever you pause spraying for 5 minutes to 2 hours.

1. Perform **Pressure Relief Procedure**, page 10.
2. Remove Battery.
3. Turn Spray Tip 90 degrees to seal orifice from drying out.

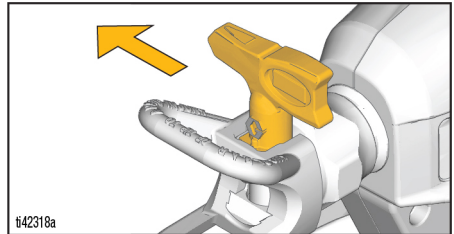

4. Ensure sprayer is fully sealed. Ensure VacuValve is closed and cup is attached to sprayer with all air evacuated.

Cleanup

NOTICE

Failure to properly clean sprayer after each use will result in hardened materials, damage to the sprayer, and the warranty will no longer be valid. Do not store solvents other than mineral spirits in sprayer. Always flush with Graco Pump Armor prior to storage.



Use only water-based materials. Do not use materials which state “FLAMMABLE” on the packaging. For more information about your material, request a Safety Data Sheet (SDS) from distributor or retailer.

Clean in a well-ventilated area. Keep a good supply of fresh air moving through the area.

To avoid serious injury or damage to equipment, do not expose the sprayer electronics to cleaning fluids. Keep sprayer **at least 10 in. (25 cm)** above the rim of the container when cleaning.

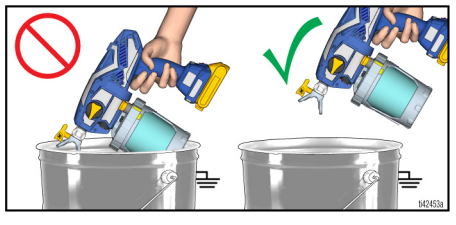

Cleaning Sprayer

Cleaning your sprayer properly and after every spray job is of the utmost importance! Proper care and maintenance will make your paint sprayer last and work for you trouble free.

1. Perform **Pressure Relief Procedure**, page 10.
2. Remove cup assembly from sprayer, and remove Pump Filter. Set sprayer on a rag.

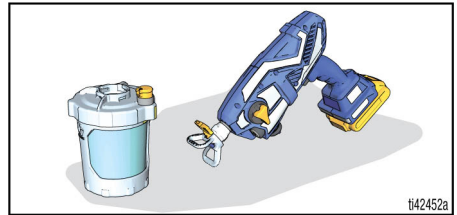

3. Remove Cup Lid and pour extra paint back into paint can. Clean all parts with warm water.

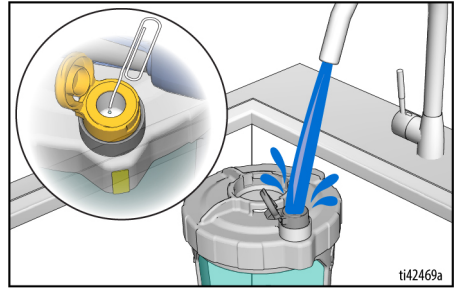

NOTE: Be sure to clean inside the VacuValve reservoir. If the VacuValve air hole becomes clogged, use a paper clip to clean hole.

Cleanup

4. To circulate cleaning fluid, fill clean cup assembly half-full of cleaning fluid and reattach to sprayer.

- a. Verify the Prime Knob is pointed down to the PRIME position.
- b. Set Speed Control to 10.

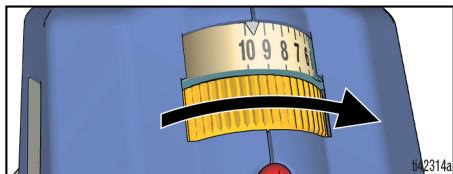

- c. Turn the sprayer upside down and trigger for 15 seconds.

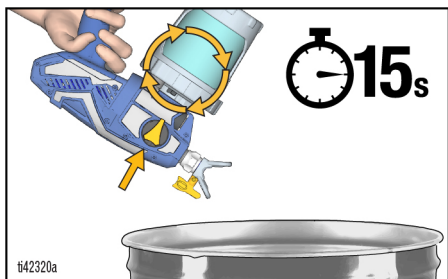

5. To spray cleaning fluid, refill cup assembly half-full of cleaning fluid and reattach to sprayer.

- a. Turn the Prime Knob forward to SPRAY position and Spray Tip to the UNCLOG position.

- b. Turn the sprayer upside down and trigger into a waste pail for 15 seconds.

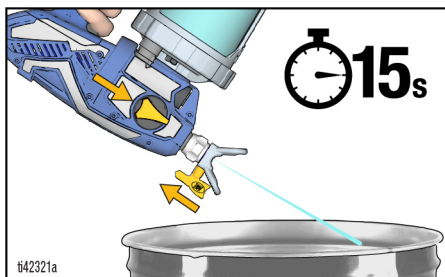

- c. Turn the Spray Tip to the SPRAY position and trigger into a waste pail for 15 seconds.

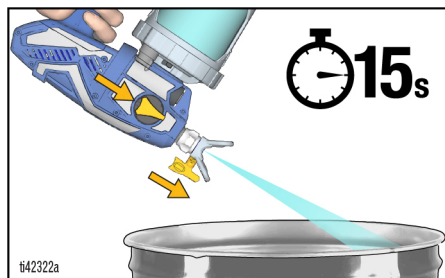

6. Repeat Cleanup steps as needed until sprayer is clean.
7. Turn Prime Knob down to PRIME position.
8. Remove Battery.
9. Remove Spray Tip from Spray Tip Guard.
10. Clean Spray Tip, Spray Tip Guard, and Pump Filter with warm water and an old toothbrush. Reinstall Spray Tip and Pump Filter.

Storage

NOTICE

Failure to store sprayer with Pump Armor™ will result in operational problems the next time you spray. Always fill the sprayer with Pump Armor after cleaning. **Water left in the sprayer will corrode and damage the pump.**

Pump Armor fluid protects the sprayer while in storage. It helps protect sprayer against startup issues on next use.

- Do not store the sprayer full of water.
 - Do not allow water to freeze in sprayer.
 - Do not store sprayer under pressure.
 - Store sprayer indoors in a cool, dry location.
 - Never store sprayer with material in the sprayer or cup.
1. Clean the sprayer and cup assembly. See **Cleanup**, page 21.
 2. Turn Prime Knob downward to PRIME position.

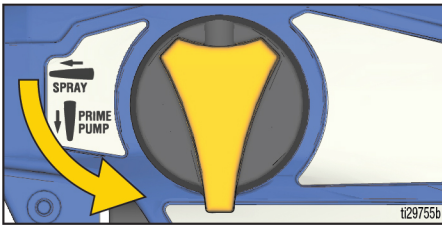

3. Remove cup assembly from sprayer and remove Pump Filter from pump.
4. Turn Prime Knob forward to SPRAY position and Spray Tip to the UNCLOG position.

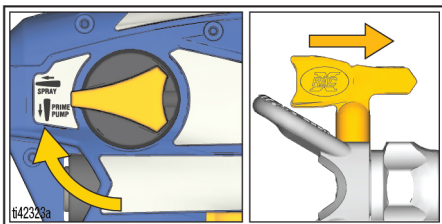

5. With the sprayer upside down, pour approximately 2 oz. (60 ml) Pump Armor (included) into pump opening.

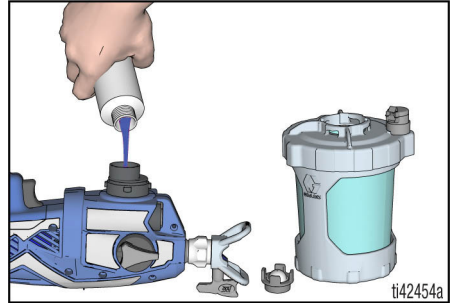

6. Install clean Pump Filter into pump.
7. Keep sprayer upside down and attach cup assembly on to the sprayer. Install Battery.
8. With the sprayer remaining upside down over a waste pail, pull the Trigger until fluid first comes out of the Spray Tip and then immediately let go of the Trigger (approx. 1 second).

NOTE: Do not spray out all fluid. Pump is now loaded with Pump Armor for storage.

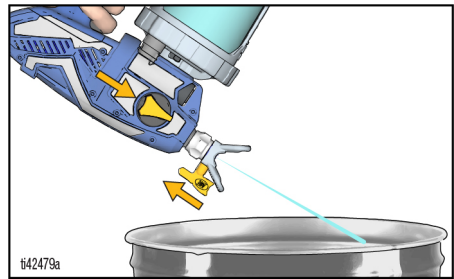

9. Turn Prime Valve to PRIME position to relieve system pressure and immediately back to SPRAY position for storage. Remove Battery.
10. Replace child-resistant cap on Pump Armor bottle and tighten securely for next use.

Reference

Cleaning Fluid Compatibility



Water-Based Materials

- When spraying **water-based** materials, flush the system thoroughly with water.
- To spray **water-based** materials, flush the system thoroughly with water first. The water flowing out of tip should be clear and clean **before** you begin spraying the water-based material.
- To avoid fluid splashing back on your skin or into your eyes, always aim gun at inside wall of pail.

Maintenance

Routine maintenance is important to ensure proper operation of your sprayer.



Move sprayer to a well-ventilated area and away from flammable or combustible materials, including paints and solvents.

Activity	Interval
Inspect Pump Filter.	Daily or each time you spray
Inspect enclosure vents for blockage.	Daily or each time you spray
Inspect pump inlet holes located under Pump Filter for blockage.	Each time the sprayer is cleaned

Cleaning Outlet Valves

Dirt and debris in the outlet valve assemblies may affect sprayer performance and require cleaning. **Perform these steps ONLY if the sprayer is not working and other troubleshooting measures have not resolved the issue.**

NOTICE

Proper tools must be used to keep the plugs/fittings from being stripped.

1. Perform **Pressure Relief Procedure**, page 10.
2. Remove the Battery.
3. To clean the three outlet valves, remove two pump plugs and front valve. Remove pump plugs with 8mm or 5/16" Allen wrench.

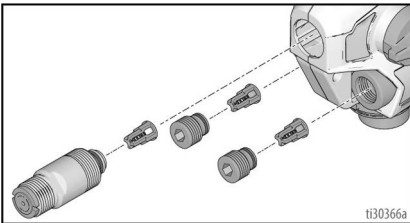

4. Clean outlet valve assemblies with warm water or mineral spirits.
5. Check ball should move freely against the spring in the retainer.
6. If outlet valve assembly was removed from the valve plug, assemble as shown.

Leave a space between the end of the plug or front valve and shoulder on the outlet valve assembly.

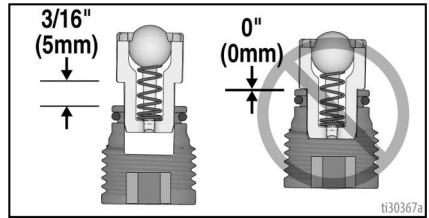

NOTICE

Do not push outlet valves all the way into the valve plugs or front valve. If outlet valves are pushed all the way into the valve plugs or front valve the sprayer will spray with reduced performance.

- a. Make certain o-rings are on the valve plugs and front valve.
- b. Install two pump plugs and front valve. Install pump plugs with 8mm or 5/16" Allen wrench. Torque outlet valve and pump plugs, see page 32 for torques.

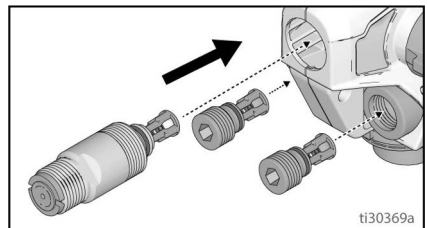

Recycling and Disposal

End of Product Life

At the end of the product's useful life, dismantle and recycle it in a responsible manner.

- Perform **Pressure Relief Procedure**, page 10.
- Drain and dispose of fluids according to applicable regulations. Refer to the material manufacturer's Safety Data Sheet.
- Remove motors, batteries, circuit boards, LCDs (liquid crystal displays), and other electronic components. Recycle according to applicable regulations.
- Do not dispose of electronic components with household or commercial waste. 
- Deliver remaining product to a recycling facility.

End of Life Disposal

If the pumping system is in a condition that it can no longer operate, the pump should be taken out of service and dismantled. Individual parts should be sorted by material and disposed of properly. Key construction materials can be found in the Materials of Construction Section.

Troubleshooting



Check everything in this Troubleshooting Table before you bring the sprayer to an authorized service center.

Sprayer Diagnostics

Problem	Cause	Solution
Sprayer makes no sound when Trigger is pulled	Diagnostic Light blinks two times when Trigger is pulled. Indicates incorrect voltage.	Replace Battery with a charged Battery.
		Battery has reached end of life. Replace the Battery.
	Diagnostic Light blinks three times when Trigger is pulled. Indicates Battery temperature is too hot or cold.	Allow Battery to cool down or warm up to room temperature.
	Diagnostic Light blinks four times when Trigger is pulled. Indicates locked rotor condition.	Replace pump and/or motor assembly.
	Diagnostic Light does not blink when Trigger is pulled. Indicates Battery is not installed or is damaged.	Install Battery or replace Battery. Replace Smartcontrol.



Troubleshooting

Problem	Cause	Solution
Sprayer makes sound but no material is sprayed when Trigger is pulled	Sprayer is not primed.	Prime the pump. See Startup , page 13.
		Make certain there is only one FlexLiner in the Cup Support.
		Make certain the cup cover is properly threaded to the Cup Support. If threads are visible below the cup cover when tight, fully remove and reinstall to the Cup Support so no threads are visible when tight.
		Make certain the cup cover is tightened to Cup Support so the arrow on cup cover is within range of indicator on Cup Support.
		Make certain the cup assembly is properly locked on the sprayer.
		Make certain all the air is out of the FlexLiner and the VacuValve is properly closed.
		Clean VacuValve reservoir and air hole. See Cleanup , page 21.
		Clean Sprayer. See Cleanup , page 21.
		Outlet valves are not installed properly. See Cleaning Outlet Valves , page 25.
		Prime Pump/Spray knob is in PRIME PUMP position.
Spray Tip is not in SPRAY position.	Turn Spray Tip to SPRAY position.	
Spray Tip is clogged.	See Clear Tip Clogs , page 18.	
Debris in paint.	Strain the paint. See Sprayer Setup , page 10.	
Pump Filter plugged.	See Cleanup , page 21.	
Speed Control is set too low.	Increase speed until unit sprays.	
No or low material in material cup.	Refill FlexLiner with material and prime the pump. See Cup Refills , page 20.	
Pump has reached the end of its life.	Replace pump assembly.	
Diagnostic Light blinks four times when the Trigger is pulled. Indicates a locked rotor condition.	Replace pump and/or motor assembly.	

Problem	Cause	Solution
Sprayer sprays with poor results	Spray Tip is partially clogged.	See Clear Tip Clogs , page 18.
	Spray Tip is not in correct position	Rotate Spray Tip to SPRAY position.
	Incorrect Spray Tip for application of material.	Install different size Spray Tip. See Tip and Pressure Selection , page 15.
	Spray Tip is worn or damaged	Replace Spray Tip. See Spray Tip Installation , page 19.
	Material being sprayed is aerated because it was shaken.	Do NOT shake material. Stir the material or check the manufacturer's recommendation for the material being sprayed.
	Material being sprayed is too cold to spray.	Warm material.
	Outlet valves are dirty or worn.	Remove two pump plugs and front valve to gain access to the three outlet valves. Clean outlet valves, see Cleaning Outlet Valves , page 25. Replace if necessary.
	Pump has reached the end of its life.	Replace pump assembly.
Pump will spray paint but will not spray water	Pump has reached the end of its life.	Replace pump assembly.
Paint leaks out of the cup threads.	Cup not properly seated.	Make certain that there is only one FlexLiner in Cup Support.
		Make certain the cup cover is properly threaded to the Cup Support. If threads are visible below the Cup Support when tight, fully remove the cup cover and reinstall to the Cup Support so no threads are visible when tight.
		Make certain the cup cover is tightened to the Cup Support so the arrow on the cup cover is within range of the indicator on the Cup Support.
		Avoid flexing or pushing on the Cup Support when you evacuate the air out of the FlexLiner.
		Avoid pulling down on the FlexLiner when you evacuate the air out of the FlexLiner.
		Make certain there is no damage to the FlexLiner lip or the cup cover gasket.
		Make certain that the FlexLiner lip and cup cover gasket is free of debris and dried paint.
		Replace FlexLiner.

Troubleshooting

Spray Pattern Diagnostics

Problem	Cause	Solution
Spray pattern is pulsating: 	Operator is moving too fast while spraying	Slow speed of movement.
	Spray Tip is clogged	See Clear Tip Clogs , page 18.
	Material is difficult to atomize	On models with Speed Control, increase speed until desired pattern is achieved. See Spraying , page 15.
	Sprayer is too far from target surface	Hold sprayer farther away from surface. See Spraying , page 15.
	Incorrect Spray Tip for application of material	Install a different size Spray Tip. See Reversible Spray Tips , page 17.
Spray pattern has tails: 	Speed Control is set too low	On models with Speed Control, increase speed until desired pattern is achieved. See Spraying , page 15.
	Incorrect Spray Tip for application of material	Install a different size Spray Tip. See Reversible Spray Tips , page 17.
	Material may need to be thinned	Thin material following paint manufacturer's recommendations.
	Material not compatible with sprayer	Change to different material.
	Spray Tip is worn or damaged	Replace Spray Tip.
Spray pattern has dripping/sagging: 	Operator is moving too slowly while spraying	Move sprayer faster when spraying.
	Sprayer is too close to target surface	Move sprayer away from surface. See Spraying , page 15.
	Holding Trigger while changing spray direction	Release Trigger when changing directions. See Spraying , page 15.
	Speed Control is set too high	On models with Speed Control, decrease speed until desired pattern is achieved. See Spraying , page 15.
	Spray Tip is worn or damaged	Replace Spray Tip.

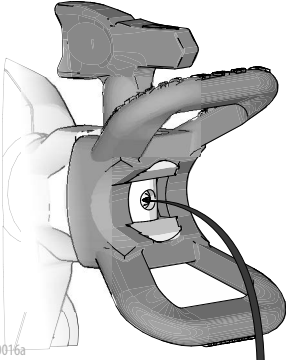
Problem	Cause	Solution
<p>Spray pattern "spits" at the end or beginning:</p>  <p>ti15525a</p>	<p>Excess material has accumulated on Spray Tip and Spray Tip Guard, or Spray Tip is partially plugged</p> <p>Spray Tip is not fully inserted into Spray Tip Guard</p> <p>Spray Tip is worn or damaged</p> <p>Pump has reached its maximum life</p>	<p>Clean Spray Tip and Spray Tip Guard. Clear Spray Tip. See Clear Tip Clogs, page 18.</p> <p>See Clear Tip Clogs, page 18.</p> <p>Replace Spray Tip.</p> <p>Replace pump.</p>
<p>Spray Tip continues to drip or ooze material after Trigger is released:</p>  <p>ti30016a</p>	<p>Spray Tip is worn.</p> <p>Spray Tip not inserted completely into Spray Tip Guard.</p>	<p>Replace Spray Tip. See Reference, page 24.</p> <p>See Reference, page 24.</p>
<p>Material leaks around Spray Tip Guard or Spray Tip handle</p>	<p>Spray Tip seal and seat are damaged or not properly installed.</p>	<p>See Reference, page 24.</p>

Replacement Parts

Replacement Parts

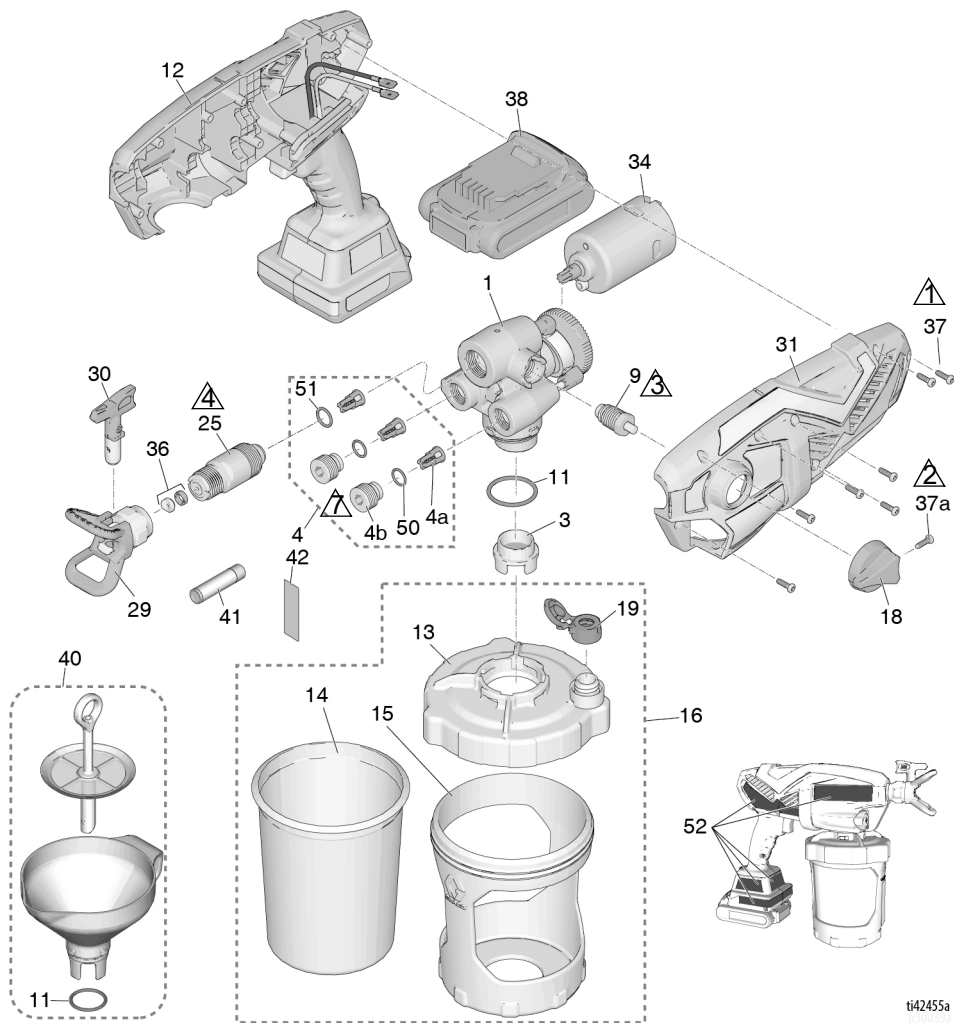

ti42455a

Ref.	Torque	Ref.	Torque
	10 in-lb (1.1 N•m)		55-65 in-lb (6.2 - 7.3 N•m)
	8-10 in-lb (0.9 - 1.1 N•m)		5-7 in-lb (0.6 - 0.8 N•m)
	10-15 in-lb (1.1 - 1.7 N•m)		

Parts List

Ref.	Sprayer Name	Part #	Description
1	All	17P186	Kit, pump assembly <i>includes 4, 9, 11, 25</i>
3	All	17P554	Filter, pump, paint, 3 pack
	All	17P555	Filter, pump, stain, 3 pack
4	All	17P183	Kit, outlet valve repair <i>includes 3 of 4a, 2 of 4b, 2 of 50, 1 of 51</i>
4a	All		Outlet valve assembly
4b	All		Outlet valve plug
9	All	17P098	Prime Pump/Spray valve <i>includes 18, 37</i>
11	All	16Y425	O-ring
12	All	17P179	Kit, Smartcontrol with enclosure <i>includes 31, 34, 7 of 37, 52</i>
13	All	17N515	Lid, cup <i>includes 1 of 19</i>
14	All	17A226	FlexLiner, 32 oz. (3-pack)
	All	17P212	FlexLiner, 32 oz. (25-pack)
	All	17F005	FlexLiner, 42 oz. (3-pack)
	All	17P549	FlexLiner, 42 oz. (25-pack)
15	Ultra, Ultimate	17N392	Support, cup, 32 oz.
16		17P550	Kit, cup support, lid and plug 32 oz. <i>includes 13, 1 of 14, 15, 17, 1 of 19</i>
		17P552	Kit, cup support, lid and plug 42 oz. <i>includes 13, 1 of 14, 15, 17, 1 of 19</i>
17	All	17M879	Plug, cup lid, not shipped with sprayer (not shown)
18	All	17M882	Prime Knob
19	All	17P712	VacuValve cap (3-pack)
20	Ultra	17P665	Kit, label, brand
	Ultimate	17R361	Kit, label, brand
25	All	17P174	Kit, front valve <i>includes 51</i>
26	Ultra, Ultimate	17M883†	Case, storage (not shown)
29	Ultra, Ultimate	246215	Guard, spray tip, FFLP
30	Ultra, Ultimate	FFLP514	Spray tip, FFLP 514
		FFLP410	Models; 17M364, 17M366
31	All	17P235	Kit, enclosure, cover <i>includes 7 of 37</i>
34	All	17P111	Motor, DC
36	All	17P501	Kit, tip seat and seal (5-pack)
37	All	17R614	Screw, cross-head
37a	All	128726	Screw, cross-head
38*	All		Li-ion Compact Battery Pack DEWALT
		17P557	Models; 17M364, 17M366, 17N220. 17P199, 17N167. Model; 17P519 requires this battery
		17P558	Model; 17N221. Model; 17P520 requires this battery
39*	All		Li-ion Battery Charger DEWALT (not shown)
		17P560	Models; 17M364, 17M366, 17N220. 17P199. Model; 17P519 requires this charger
		17P559	Model 17N167
		17P561	Model; 17N221. Model; 17P520 requires this charger
40	All	18B057	Kit, funnel, strainer <i>includes qty. 1 of ref. 11</i>
41	All	25T467	Lubricant, seal lube
42	All	17K515	Label, A+ Service
50	All	17M394	O-ring
51	All	125119	O-ring
- - -		17A000	Pump Armor, shipped with sprayer 4 oz (not shown)
- - -		253574	Pump Armor, not shipped with sprayer 8 oz (not shown)
52 ▲	All	17P681	Kit, warning labels (not shown)

Replacement Parts

Ref.	Sprayer Name	Part #	Description
53 ▲			Medical alert card (not shown)
		17R476	English, Spanish, Portuguese (Brazil)
		17A134	English, Chinese, Korean
		179960	English, Spanish, French
		17F690	Dutch, German, Italian
▲ Replacement safety labels, tags, and cards are available at no cost.			
† Not included with PN 17P515, 17P516, 17P518, 17P928, and 17P929.			
* Battery and charger are dependent upon in country requirements.			

Technical Specifications

Cordless HandHeld Sprayer		
	U.S.	Metric
Max Working Pressure	2000 psi	14 MPa, 138bar
Weight	5.25 lb	2.4 kg
Dimensions:		
Length	14.0 in.	36.1 cm
Width	5 in.	12.7 cm
Height	10.5 in.	26.7 cm
Storage Temperature Range ♦❖	32° to 113° F	0° to 45° C
Operating Temperature Range ✓	40° to 90° F	4° to 32° C
Storage Humidity Range	0% to 95% relative humidity, non-condensing	
Sound Pressure Level	86.0 dBa	
Sound Power Level†	90.7 dBa, Uncertainty = 0.5 dBa	
Vibration Level (measured in accordance with EN 50580:2012)	Vibration total value $a_h = 33.2 \text{ ft/s}^2$ Uncertainty = 0.5 m/s ²	Vibration total value $a_h = 10.1 \text{ m/s}^2$ Uncertainty = 0.2 m/s ²
Charger Power Source		
17N167	100 Vac, 50 Hz, 15A, 1 Ø	
17M366, 17M364, 17P519, 17N220, 17N221, 17P520	230 Vac, 50 Hz, 16A, 1 Ø	
Battery Voltage (DC)	20 V MAX* 2.0 Ah Li-ion Compact Battery Pack DEWALT	
Maximum tip orifice	0.016 in.	0.41mm

♦ Pump damage will occur if fluid freezes in pump.

❖ Damage to plastic parts may result if impact occurs in low temperature conditions.

✓ Changes in paint viscosity at very low or very high temperatures can affect sprayer performance.

† All readings were taken within the priming mode at the assumed operator position. Sound power levels were tested to ISO 3741 at 3.3 feet (1m).

* Maximum initial battery voltage (measured without a workload) is 20 volts. Nominal voltage is 18.

Graco Standard Warranty

Graco warrants all equipment referenced in this document which is manufactured by Graco and bearing its name to be free from defects in material and workmanship on the date of sale to the original purchaser for use. With the exception of any special, extended, or limited warranty published by Graco, Graco will, for a period of twelve months from the date of sale, repair or replace any part of the equipment determined by Graco to be defective. This warranty applies only when the equipment is installed, operated and maintained in accordance with Graco's written recommendations.

This warranty does not cover, and Graco shall not be liable for general wear and tear, or any malfunction, damage or wear caused by faulty installation, misapplication, abrasion, corrosion, inadequate or improper maintenance, negligence, accident, tampering, or substitution of non-Graco component parts. Nor shall Graco be liable for malfunction, damage or wear caused by the incompatibility of equipment with structures, accessories, equipment or materials not supplied by Graco, or the improper design, manufacture, installation, operation or maintenance of structures, accessories, equipment or materials not supplied by Graco.

This warranty is conditioned upon the prepaid return of the equipment claimed to be defective to an authorized Graco distributor for verification of the claimed defect. If the claimed defect is verified, Graco will repair or replace free of charge any defective parts. The equipment will be returned to the original purchaser transportation prepaid. If inspection of the equipment does not disclose any defect in material or workmanship, repairs will be made at a reasonable charge, which charges may include the costs of parts, labor, and transportation.

THIS WARRANTY IS EXCLUSIVE, AND IS IN LIEU OF ANY OTHER WARRANTIES, EXPRESS OR IMPLIED, INCLUDING BUT NOT LIMITED TO WARRANTY OF MERCHANTABILITY OR WARRANTY OF FITNESS FOR A PARTICULAR PURPOSE.

Graco's sole obligation and buyer's sole remedy for any breach of warranty shall be as set forth above. The buyer agrees that no other remedy (including, but not limited to, incidental or consequential damages for lost profits, lost sales, injury to person or property, or any other incidental or consequential loss) shall be available. Any action for breach of warranty must be brought within two (2) years of the date of sale.

GRACO MAKES NO WARRANTY, AND DISCLAIMS ALL IMPLIED WARRANTIES OF MERCHANTABILITY AND FITNESS FOR A PARTICULAR PURPOSE, IN CONNECTION WITH ACCESSORIES, EQUIPMENT, MATERIALS OR COMPONENTS SOLD BUT NOT MANUFACTURED BY GRACO. These items sold, but not manufactured by Graco (such as electric motors, switches, hose, etc.), are subject to the warranty, if any, of their manufacturer. Graco will provide purchaser with reasonable assistance in making any claim for breach of these warranties.

In no event will Graco be liable for indirect, incidental, special or consequential damages resulting from Graco supplying equipment hereunder, or the furnishing, performance, or use of any products or other goods sold hereto, whether due to a breach of contract, breach of warranty, the negligence of Graco, or otherwise.

FOR GRACO CANADA CUSTOMERS

The Parties acknowledge that they have required that the present document, as well as all documents, notices and legal proceedings entered into, given or instituted pursuant hereto or relating directly or indirectly hereto, be drawn up in English. Les parties reconnaissent avoir convenu que la rédaction du présente document sera en Anglais, ainsi que tous documents, avis et procédures judiciaires exécutés, donnés ou intentés, à la suite de ou en rapport, directement ou indirectement, avec les procédures concernées.

Graco Information

For the latest information about Graco products, visit www.graco.com.

For patent information, see www.graco.com/patents.

TO PLACE AN ORDER, contact your Graco distributor or call 1-888-541-9788 to identify the nearest distributor.

DEWALT® and the DEWALT Logo are trademarks of DEWALT Industrial Tool Co. and are used under license

All written and visual data contained in this document reflects the latest product information available at the time of publication.

Graco reserves the right to make changes at any time without notice.

Original instructions. This manual contains English. MM 3A4749

Graco Headquarters: Minneapolis

International Offices: Belgium, China, Japan, Korea

GRACO INC. AND SUBSIDIARIES • P.O. BOX 1441 • MINNEAPOLIS MN 55440-1441 • USA

Copyright 2017, Graco Inc. All Graco manufacturing locations are registered to ISO 9001.

www.graco.com

Revision E, May 2024