

InvisiPac[®] Material Tracking Kit

3A3158C

EN

Use the InvisiPac Material Tracking Kit to gather adhesive usage statistics on InvisiPac HM25 or HM50. For professional use only.

Not approved for use in explosive atmospheres or hazardous locations.



Important Safety Instructions

Read all instructions in this manual and all warnings and instructions in the InvisiPac system manual 333347. Save these instructions.

Step 1: Update system software

Kit 24Y162:

Install the black token to update the system software.



Wait until the ADM indicates that the update is complete.

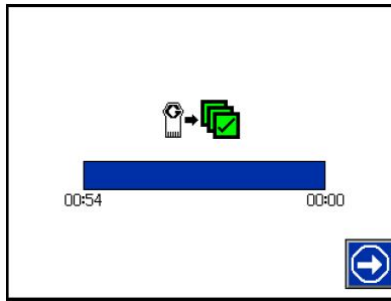

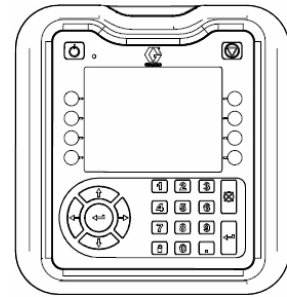

Kit 24Y672:

Install and leave the blue token to enable material tracking.

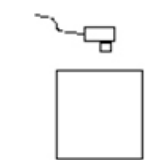

NOTE (PC-8e systems only): Remove the blue key token 24X626 to install the update. Re-install the blue key token after the software update.

Step 2: Mount photo-eye

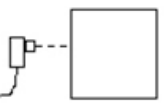
Diffuse Sensor		Adjust sensitivity for proper operation Range: 200 mm	
Retro-Reflective Sensor		Requires reflector Range 3.5 m	

Step 3: Connect photo-eye to ADM

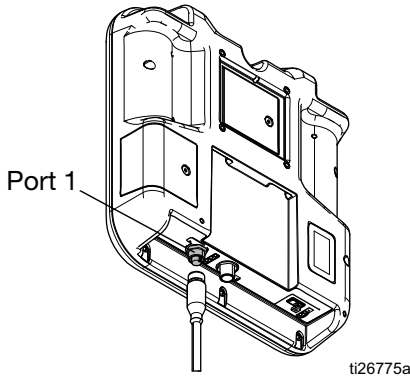

Step 4: Enable ADM unit counter

Navigate to Setup Screens. Select "Enable ADM Unit Counter" on page 4 of System screen.

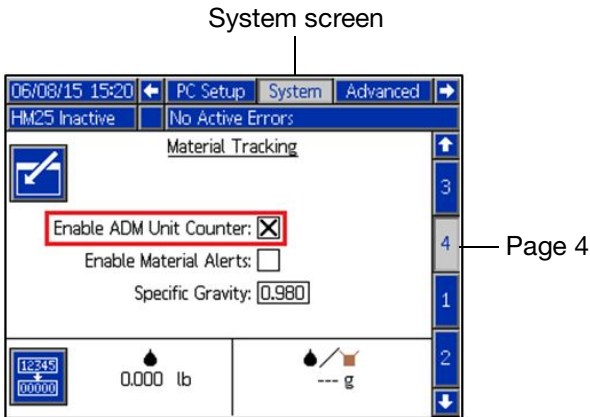

Step 5: View material log

Press  softkey on the InvisiPac Home Screen. Verify unit counter updates properly.

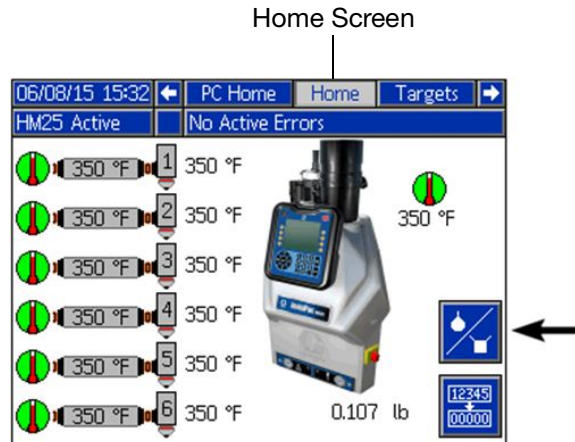

All written and visual data contained in this document reflects the latest product information available at the time of publication. Graco reserves the right to make changes at any time without notice.

Original instructions. This manual contains English. MM 3A3158

Graco Headquarters: Minneapolis

International Offices: Belgium, China, Japan, Korea

GRACO INC. AND SUBSIDIARIES • P.O. BOX 1441 • MINNEAPOLIS MN 55440-1441 • USA
Copyright 2014, Graco Inc. All Graco manufacturing locations are registered to ISO 9001.

www.graco.com

Revision C, September 2024