

XMTM PFP

Plural-Component Sprayer

3A2776S

EN

For spraying two-component passive fire protection (PFP) intumescent epoxies.
For professional use only.



Important Safety Instructions

Read all warnings and instructions in this manual and in all related manuals before using this equipment. Save all instructions.

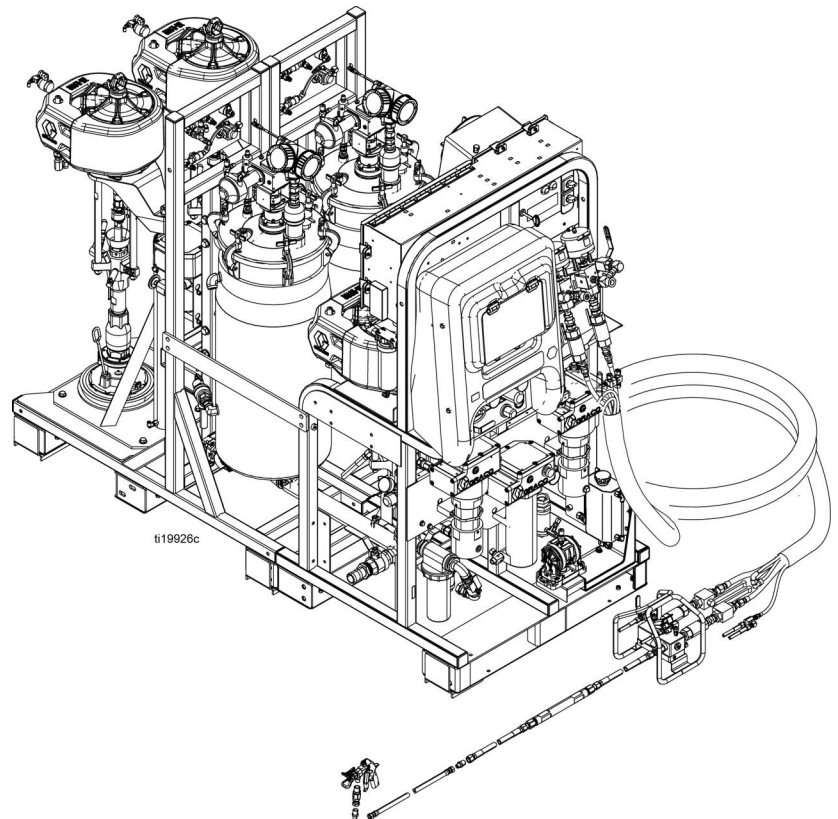

See page 3 for model information, including maximum working pressure and approvals.



Contents

Models	3	Pressure Relief Procedure	45
Related Manuals	4	System Verification	47
Warnings	5	Pump and Metering Test and Calibration for Ratio by Weight Mode	47
Keep Components A and B Separate	8	Batch Dispense or Ratio Test	49
Components A and B	8	Down Stream Valve Leak Test	51
Changing Materials	8	Mix and Integration Tests	52
Component Identification	9	Empty and Flush Entire System	53
Typical Setup (Front View)	9	Prepare Level Sensor for Shipping	56
Typical Setup (Back View)	10	Download Data from USB	57
Fluid Control Assembly	11	USB Logs	57
Main Power and Heater Controls	12	Download Setup	57
Sprayer and Flush Pump Air Controls	13	Download Procedure	57
Feed Module Air Controls	14	Maintenance	59
User Interface	15	Adjust Packing Nuts	59
Setup	17	Filters	59
Location	17	Seals	59
Unboxing	17	Battery	59
Ratio Configuration	17	Clean the System	60
Configuration Options	17	Troubleshooting Information	61
Grounding	19	Alarms	61
Connect Power Cord	19	General Tips	61
Set Power Jumpers	20	Individual Control Module LED Diagnostic Information	62
Connect Air Supply	20	Troubleshooting	62
Connect Feed Module Lines to Sprayer Module	21	Appendix A - User Interface Display	66
Install Level Sensor Probes	22	Change a Setting	66
Level Sensor Calibration	23	Alarms	66
Connect the Fluid Hose Bundle to the System .	23	Setup Mode Screens	67
Connect the Fluid Hose Bundle to the Mix Manifold	24	Operator Command Mode Screens	74
Connect the Mix Manifold to the Gun	25	Test Screens	77
Connect Tank Heat Circulation Hoses	25	Information Screens	80
Prime Heated Hose Bundle Fluid Circulation System	25	Automatically Displayed Screens	83
Initial Startup	29	Appendix B - Alarms	84
Prime Flush Pump	35	Alarms Overview	84
Adjust Ratio and System Settings	37	Alarm Code Troubleshooting	88
Verify Desired Ratio Mode	37	Check RTD Cables and FTS	96
Adjust Ratio Set Point	37	Dimensions	97
Temperature Settings	37	Technical Specifications	98
Spray	39	Graco Standard Warranty	100
Flush Mixed Material	43	Graco Information	100
Park Metering Pump Rods	44		

Models

System	Base System	Series	Location	Ratio Range	Approvals
24W626	262878	C	Non-Hazardous	1:1 to 1.5:1	<p>Not for use in explosive atmospheres or hazardous locations.</p>  <p>Intertek 9902471 Certified to CAN/CSA C22.2 No. 88 Conforms to UL 499</p>
262869				1.5:1 to 4:1	
262898*					
262945†	262941	B	Hazardous	1:1 to 1.5:1	 <p>Ex II 2 G Ex db ia pxb IIA T3 Gb Ta = 0°C to 54°C ITS21UKEX0232X IECEX ETL 15.0020X</p>
262943†				1.5:1 to 4:1	

See **Technical Specifications**, page 98, for additional information.

Maximum Fluid Working Pressure	Maximum Air Working Pressure
<p><i>A and B Materials:</i> 6000 psi (41 MPa, 414 bar)</p> <p><i>Flushing Fluid:</i> 4500 psi (31 MPa, 310 bar)</p> <p><i>Heating Fluid:</i> 100 psi (0.7 MPa, 7 bar)</p>	<p><i>Supply:</i> 150 psi (1.0 MPa, 10.3 bar)</p> <p><i>Maximum Setpoint:</i> Main Pump: 100 psi (0.7 MPa, 7 bar) Feed Pump: 65 psi (0.45 MPa, 4.5 bar)</p>
<p>* Includes Air Dryer Kit 262896 and Gun & Mix Line Kit 24P833</p>	
<p>† Includes Hot Water Flush Kit 24X113</p>	



Related Manuals



Manuals are available at www.graco.com:









Manual in English	Description
3A2989	XM PFP Repair
3A2988	XM PFP Mix Manifold Instructions - Parts
3A2799	XHF™ Spray Gun
Heaters	
309524	Viscon® HP High Pressure Fluid Heater Instructions - Parts
3A2954	Viscon HF High Flow, High Pressure Fluid Heater Instructions - Parts
Pumps, Motors, Supply Systems	
308652	Husky™ 205 Air-Operated Diaphragm Pumps Instructions - Parts
311762	Xtreme® Lowers Instructions - Parts
312375	Check-Mate® Displacement Pumps Instructions - Parts
312376	Check-Mate Pump Packages Instructions - Parts
312792	Merkur® Pump Repair - Parts
312794	Merkur Pump Assembly Instructions - Parts
313526	Supply Systems Operation
313527	Supply Systems Repair - Parts
312374	Air Control Instructions - Parts
Accessories	
332073	Hot Water Flush Kit Instructions
3A2987	Air Dryer Kit Instructions
406691	Hose Rack Parts
334931	Caster Kit Instructions
Other	
306861	Ball Valves Instructions - Parts
307005	High Pressure Swivel Instructions - Parts
308169	Air Filters, Lubricators, and Kits Instructions - Parts
407061	Simulation XM PFP Display Module
3A1244	Graco Control Architecture Module Programming
334939	1:1 Ratio Adapter Kit Instructions
3A3072	Heater Upgrade Kit Instructions
3A5423	XL6500 and 3400 Air Motors - Parts
3B0244	Overflow Tank Kit - Instructions - Parts

Warnings





The following warnings are for the setup, use, grounding, maintenance, and repair of this equipment. The exclamation point symbol alerts you to a general warning and the hazard symbols refer to procedure-specific risks. When these symbols appear in the body of this manual or on warning labels, refer back to these Warnings. Product-specific hazard symbols and warnings not covered in this section may appear throughout the body of this manual where applicable.

 DANGER	
	<p>SEVERE ELECTRIC SHOCK HAZARD</p> <p>This equipment can be powered by more than 240 V. Contact with this voltage will cause death or serious injury.</p> <ul style="list-style-type: none"> • Turn off and disconnect power at main switch before disconnecting any cables and before servicing equipment. • This equipment must be grounded. Connect only to grounded power source. • All electrical wiring must be done by a qualified electrician and comply with all local codes and regulations.

 WARNING	
	<p>SPECIAL CONDITIONS FOR SAFE USE</p> <ul style="list-style-type: none"> • Potential risk of electrostatic discharge. See instructions for guidance to minimize the risk of electrostatic discharge. • The system must be earthed using copper conductors according to the installation instructions. All intrinsically safe circuits must be connected to ground at one point. • For information on the required dimensions of the flameproof joints contact the holder of this certificate (Graco Inc.); Flame-path joints are not intended to be repaired. • Special fasteners for securing equipments covers on the flameproof heaters shall have a minimum yield strength of 1,100 MPa and be corrosion resistant and sized M8 x 1.25 x 30.
	<p>FIRE AND EXPLOSION HAZARD</p> <p>Flammable fumes, such as solvent and paint fumes, in work area can ignite or explode. Paint or solvent flowing through the equipment can cause static sparking. To help prevent fire and explosion:</p> <ul style="list-style-type: none"> • Use equipment only in well ventilated area. • Eliminate all ignition sources; such as pilot lights, cigarettes, portable electric lamps, and plastic drop cloths (potential static sparking). • Ground all equipment in the work area. See Grounding instructions. • Never spray or flush solvent at high pressure. • Keep work area free of debris, including solvent, rags and gasoline. • Do not plug or unplug power cords, or turn power or light switches on or off when flammable fumes are present. • Use only grounded hoses. • Hold gun firmly to side of grounded pail when triggering into pail. Do not use pail liners unless they are anti-static or conductive. • Stop operation immediately if static sparking occurs or you feel a shock. Do not use equipment until you identify and correct the problem. • Keep a working fire extinguisher in the work area.

 <h1 style="margin: 0;">WARNING</h1>	
    	<p>SKIN INJECTION HAZARD</p> <p>High-pressure fluid from gun, hose leaks, or ruptured components will pierce skin. This may look like just a cut, but it is a serious injury that can result in amputation. Get immediate surgical treatment.</p> <ul style="list-style-type: none"> • Do not spray without tip guard and trigger guard installed. • Engage trigger lock when not spraying. • Do not point gun at anyone or at any part of the body. • Do not put your hand over the spray tip. • Do not stop or deflect leaks with your hand, body, glove, or rag. • Follow the Pressure Relief Procedure when you stop spraying and before cleaning, checking, or servicing equipment. • Tighten all fluid connections before operating the equipment. • Check hoses and couplings daily. Replace worn or damaged parts immediately.
	<p>BURN HAZARD</p> <p>Equipment surfaces and fluid that's heated can become very hot during operation. To avoid severe burns:</p> <ul style="list-style-type: none"> • Do not touch hot fluid or equipment.
 	<p>MOVING PARTS HAZARD</p> <p>Moving parts can pinch, cut or amputate fingers and other body parts.</p> <ul style="list-style-type: none"> • Keep clear of moving parts. • Do not operate equipment with protective guards or covers removed. • Pressurized equipment can start without warning. Before checking, moving, or servicing equipment, follow the Pressure Relief Procedure and disconnect all power sources.

! WARNING

 	<p>EQUIPMENT MISUSE HAZARD</p> <p>Misuse can cause death or serious injury.</p> <ul style="list-style-type: none"> • Do not operate the unit when fatigued or under the influence of drugs or alcohol. • Do not exceed the maximum working pressure or temperature rating of the lowest rated system component. See Technical Specifications in all equipment manuals. • Use fluids and solvents that are compatible with equipment wetted parts. See Technical Data in all equipment manuals. Read fluid and solvent manufacturer’s warnings. For complete information about your material, request Safety Data Sheet (SDS) from distributor or retailer. • Do not leave the work area while equipment is energized or under pressure. • Turn off all equipment and follow the Pressure Relief Procedure when equipment is not in use. • Check equipment daily. Repair or replace worn or damaged parts immediately with genuine manufacturer’s replacement parts only. • Do not alter or modify equipment. Alterations or modifications may void agency approvals and create safety hazards. • Make sure all equipment is rated and approved for the environment in which you are using it. • Use equipment only for its intended purpose. Call your distributor for information. • Route hoses and cables away from traffic areas, sharp edges, moving parts, and hot surfaces. • Do not kink or over bend hoses or use hoses to pull equipment. • Keep children and animals away from work area. • Comply with all applicable safety regulations.
	<p>TOXIC FLUID OR FUMES HAZARD</p> <p>Toxic fluids or fumes can cause serious injury or death if splashed in the eyes or on skin, inhaled, or swallowed.</p> <ul style="list-style-type: none"> • Read Safety Data Sheets (SDSs) to know the specific hazards of the fluids you are using. • Store hazardous fluid in approved containers, and dispose of it according to applicable guidelines.
	<p>SPLATTER HAZARD</p> <p>Hot or toxic fluid can cause serious injury if splashed in the eyes or on skin. During blow off of platen, splatter may occur.</p> <ul style="list-style-type: none"> • Use minimum air pressure when removing platen from drum.
	<p>PERSONAL PROTECTIVE EQUIPMENT</p> <p>Wear appropriate protective equipment when in the work area to help prevent serious injury, including eye injury, hearing loss, inhalation of toxic fumes, and burns. Protective equipment includes but is not limited to:</p> <ul style="list-style-type: none"> • Protective eyewear, and hearing protection. • Respirators, protective clothing, and gloves as recommended by the fluid and solvent manufacturer.

Keep Components A and B Separate



Cross-contamination can result in cured material in fluid lines which could cause serious injury or damage equipment. To prevent cross-contamination:

- **Never** interchange component A and component B wetted parts.
- Never use solvent on one side if it has been contaminated from the other side.

Components A and B

IMPORTANT!

Material suppliers can vary in how they refer to plural component materials.

Be aware that in this manual:

Component A refers to resin or major volume.

Component B refers to the hardener or minor volume.

This equipment doses the B component into the A component flow. An integration hose must always be used after the mix manifold and before the static mixer.

Changing Materials

NOTICE

Changing the material types used in your equipment requires special attention to avoid equipment damage and downtime.

- When changing materials, flush the equipment multiple times to ensure it is thoroughly clean.
- Always clean the fluid inlet strainers after flushing.
- Check with your material manufacturer for chemical compatibility.
- When changing between epoxies and urethanes or polyureas, disassemble and clean all fluid components and change hoses. Epoxies often have amines on the B (hardener) side. Polyureas often have amines on the B (resin) side.

Component Identification

Typical Setup (Front View)

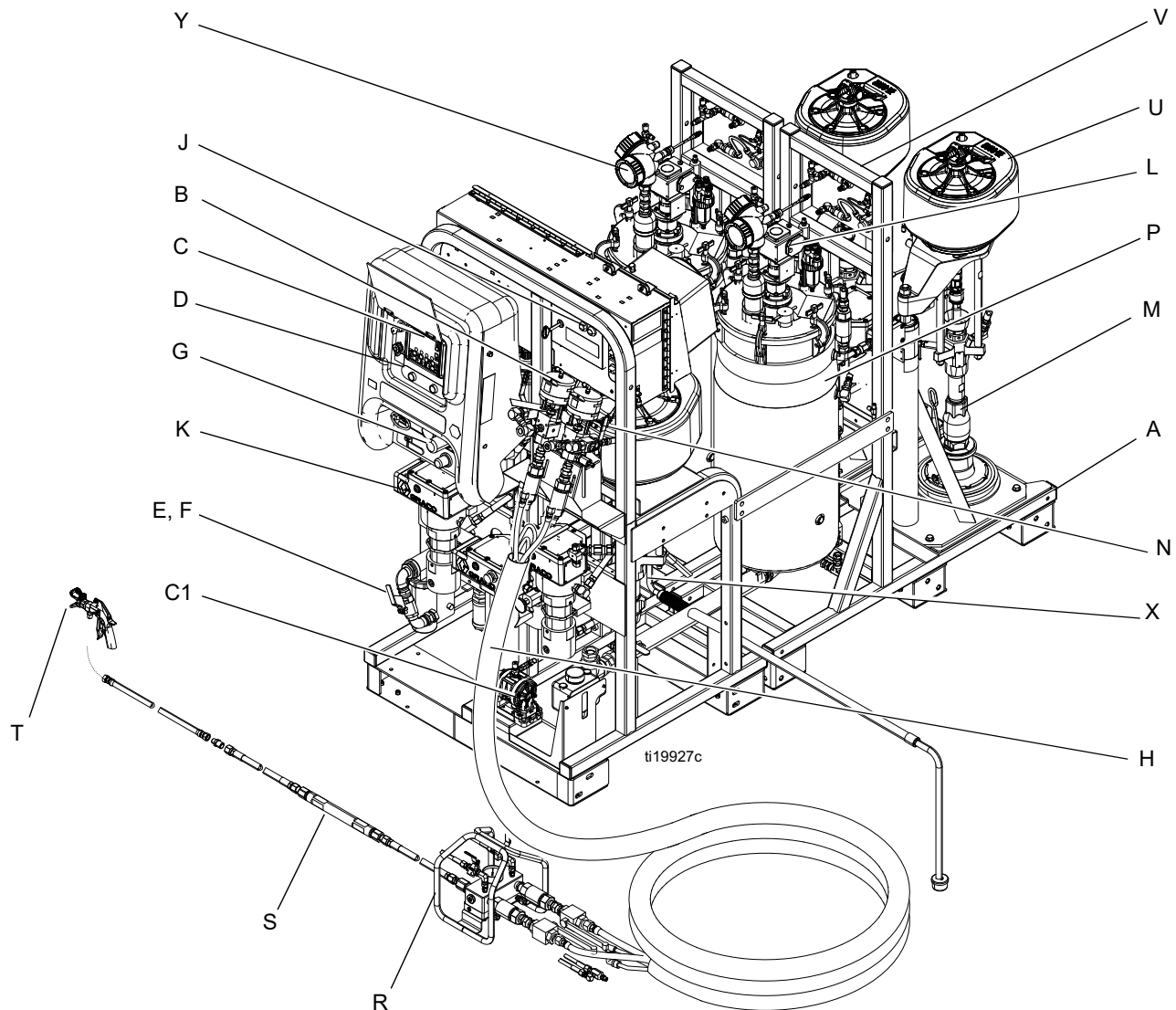

FIG. 1

Ref.	Description	Ref.	Description
A	Frame	M	Feed Pump
B	Fluid Control Assembly (see page 11)	N	Recirculation Control Valve
C	User Interface (see page 15)	P	Pressure Tank, Double-Wall Temperature Conditioned
D	Metering Pumps Control On and Off Buttons	R	Remote Mix Manifold
E	Main Air Supply Shutoff Valve, 1 in. npt(f) Inlet	S	Static Mixer Assembly
F	Air Filter, 1-1/4 in.	T	Spray Gun
G	Air Controls for Sprayer and Flush Pump (see page 13)	U	Air Motor
H	Viscon HP Heater for hose bundle	V	Feed Module Air Controls (see page 14)
J	Main Power and Heater Controls (see page 12)	X	Flush Pump (Merkur Pump)
K	Viscon HF Material Heater	Y	Radar Fluid Level Sensor
L	Air Powered Agitator with Lubricator	C1	Heated Fluid Circulation Pump for Hose Bundle

Typical Setup (Back View)

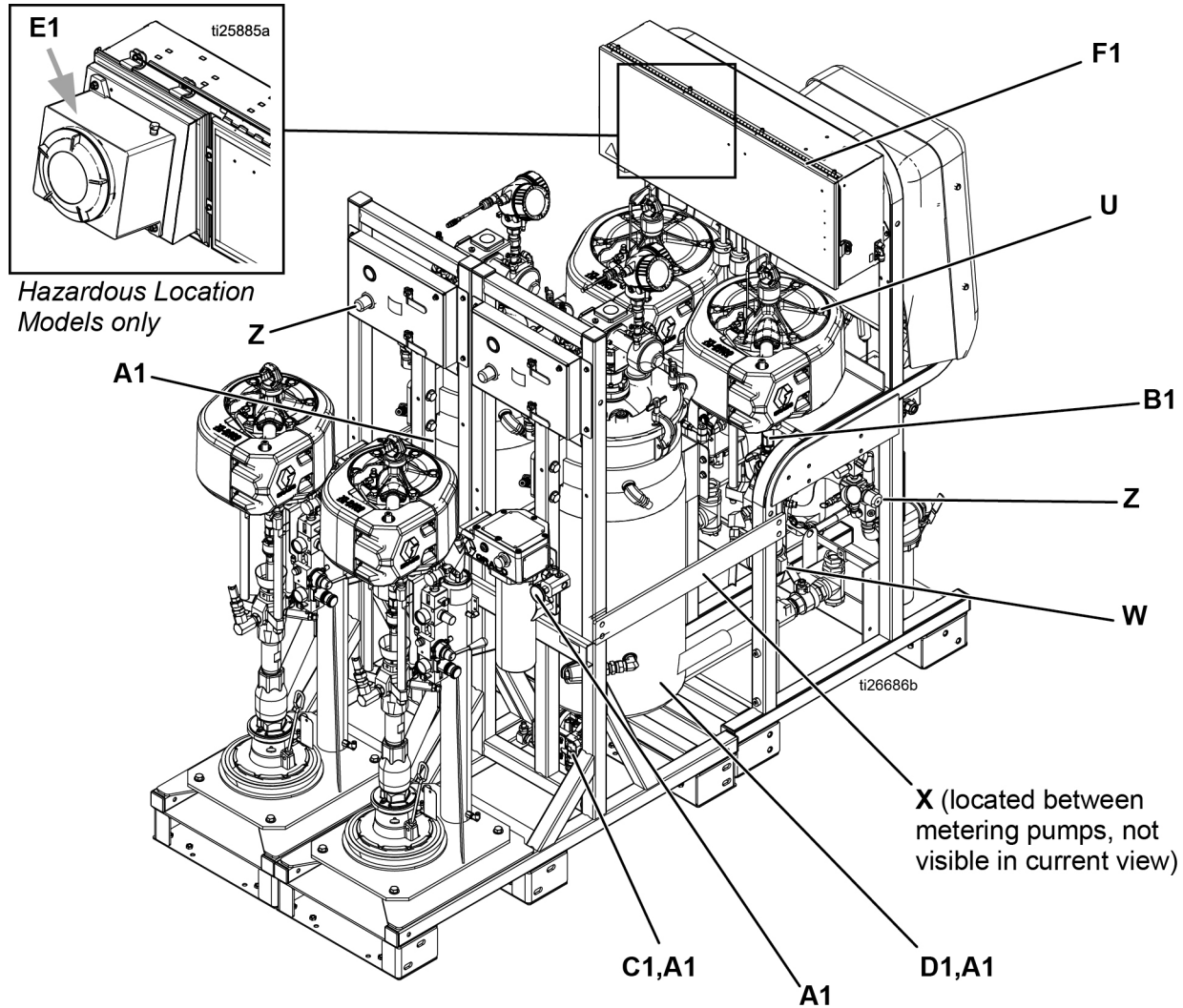

FIG. 2

Ref. Description

- U Air Motor
- W High Pressure Fluid Metering Pump
- X Flush Pump (Merkur Pump)
- Z Air Regulator for Feed Tanks and Pumps

Ref. Description

- A1 Heated Tank Circulation Components (uses a Viscon)
- B1 TSL™ Supply Bottle and Bracket
- C1 Heated Fluid Circulation Pump for Hose Bundle
- D1 Insulation Jacket
- E1 Explosion Proof Box
(Hazardous Location System only)
- F1 Junction Box Non-Hazardous Location System only)
or Purge Box (Hazardous Location System only)

Fluid Control Assembly

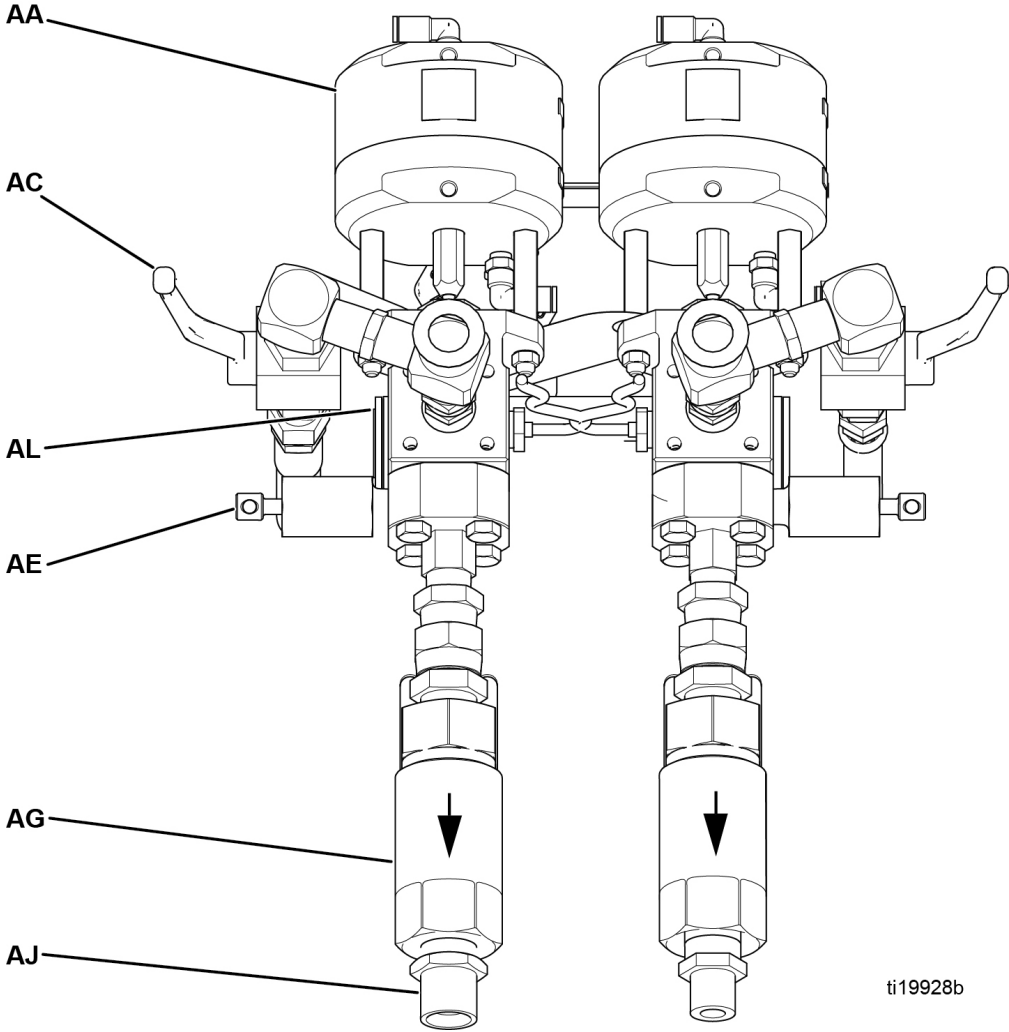

ti19928b

FIG. 3

- AA Dosing Valve
- AC Recirculation Valve
- AE Sampling Valve
- AG Outlet Check Valve
- AJ Hose Connection (Model 262869) - A side: 3/4 npt(m); B side: 1/2 npt(m)
Hose Connection (Model 24W626) - A side: 3/4 npt(m); B side 3/4 npt(m)
- AL Pressure Sensor

Main Power and Heater Controls

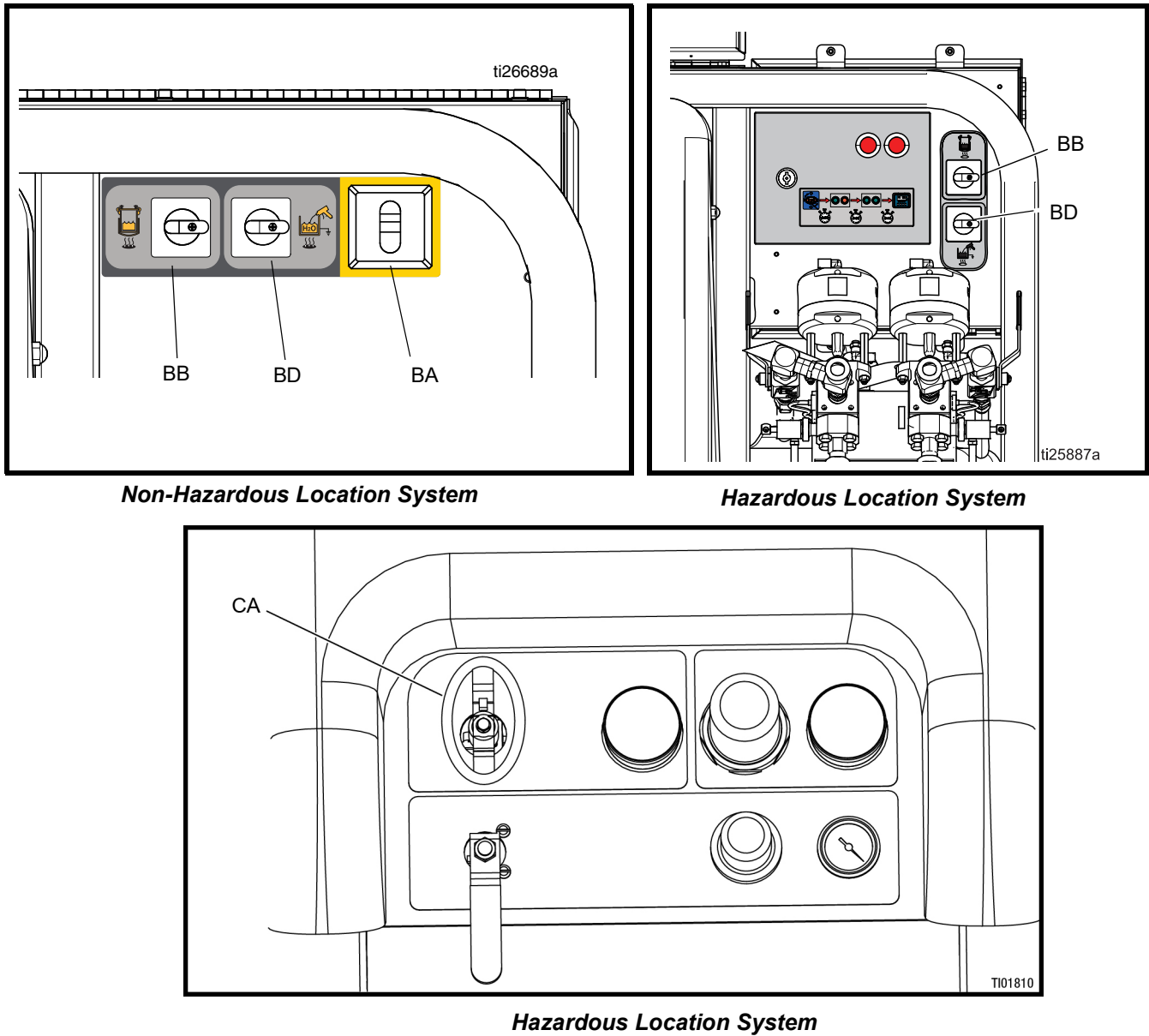

FIG. 4

BA Main Power ON/OFF Switch (non hazardous location)
BB A and B Tank Water Heat ON/OFF Switch

BD Optional Heated Water Flush Tank Accessory ON/OFF Switch (only used if the water heater accessory has been added to the machine) (standard on hazardous location models)

CA Main Power ON/OFF Switch (hazardous location)

Sprayer and Flush Pump Air Controls

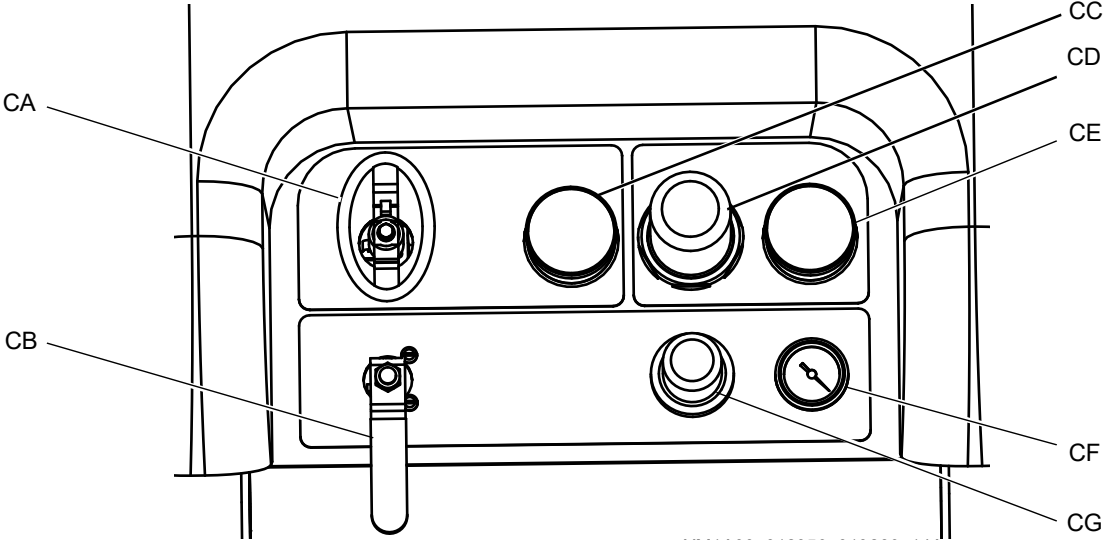

r_XM1A00_312359_313289_14A

FIG. 5

- CA Metering Pump Air On/Off Control (non hazardous location)
Main Power On/Off Switch (hazardous location), see **Main Power and Heater Controls**, page 12
- CB Flush Pump Air On/Off Control

- CC Inlet Air Pressure Gauge
- CD Metering Pump Air Regulator
- CE Metering Pump Air Regulator Gauge
- CF Flush Pump Air Gauge
- CG Flush Pump Air Regulator

Feed Module Air Controls

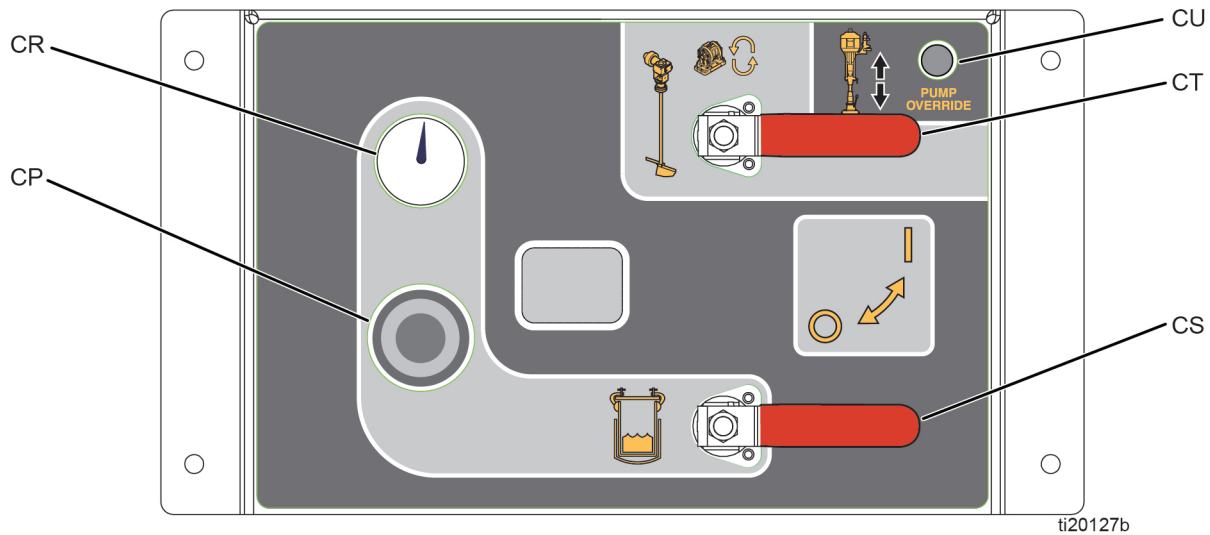

NOTE: Both valves shown open

FIG. 6: Supply Controls

- CP Tank Air Pressure Regulator
- CR Tank Air Pressure Gauge
- CS Tank Air Supply Valve
- CT Agitator and Heated Water Circulation On/Off Valve
- CU Feed Pump Override Button

Feed Pump Override Button

Use the feed pump override button (CU) to manually run the feed pump when the automatic tank filling function is not running the feed pump. See automatic tank filling details on page 82.

Feed Pump Air Controls

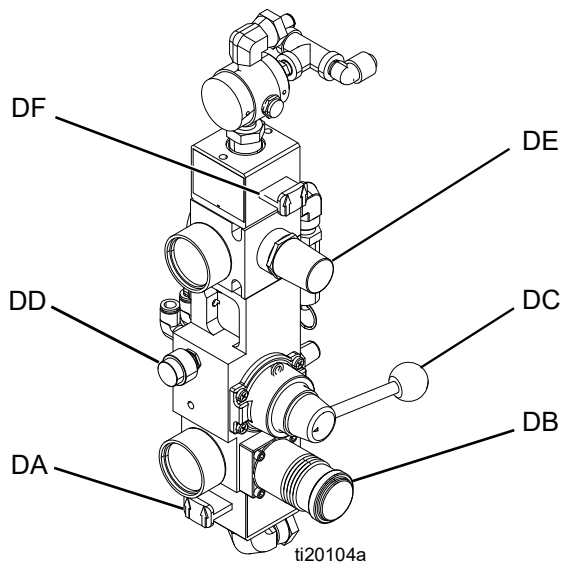

- DA RAM Air ON/Exhaust Slider Valve
- DB RAM Air Regulator
- DC RAM Up/Down Director Valve
- DD RAM Blowoff Valve
- DE Air Motor Regulator
- DF Air Motor ON/Exhaust Slider Valve

RAM Blowoff Valve (DD)



To minimize material splatter, use the minimum air pressure required to remove platen from pail.

To easily remove the RAM from the pail, press and hold the RAM Blowoff Valve button while lifting the RAM platen. A small amount of air pressure will be supplied to the pail to push the pail off of the RAM.

User Interface

NOTICE
To prevent damage to soft key buttons, do not press the buttons with sharp objects such as pens, plastic cards, or fingernails.

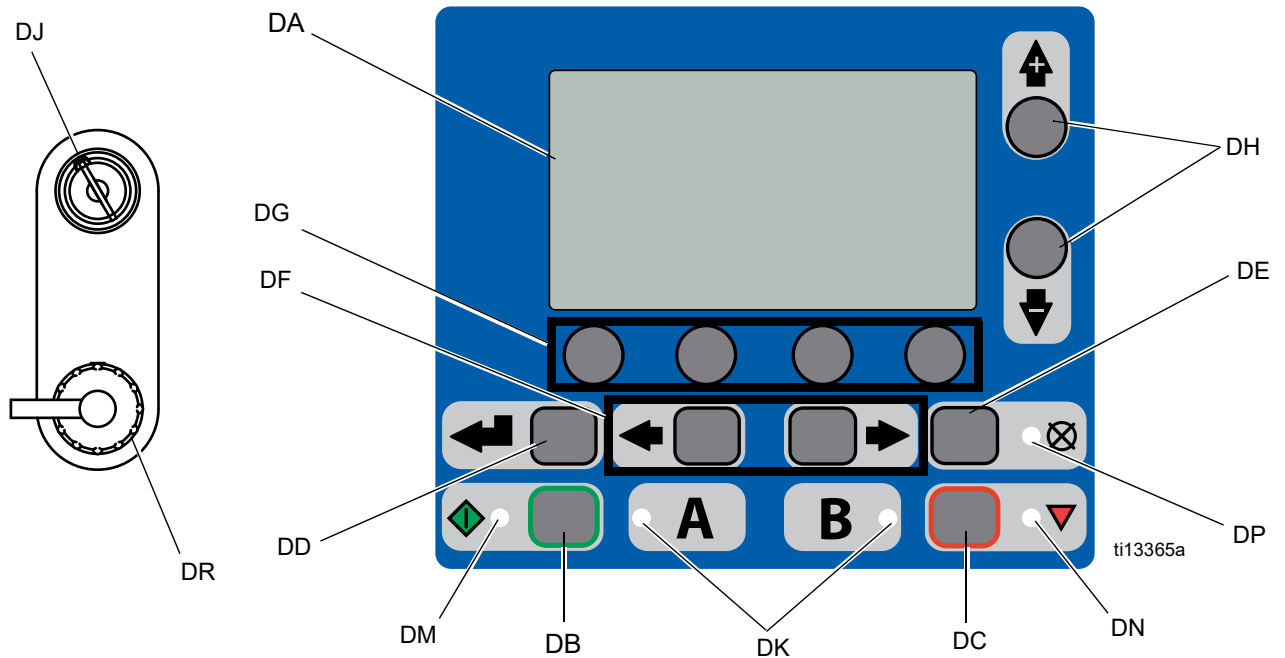

FIG. 7: User Interface

Buttons

Ref.	Button	Function
DA	Display Screen	Use to view screens. See page 66.
DB	Start	Initiates Active Run Mode function currently selected in Run Screen.
DC	Stop	Terminates Active Run Mode function currently selected.
DD	Enter	Press to open drop-down fields, select options, and save values.
DE	Alarm Reset	Resets alarms and advisories.
DF	Left/Right	Move between screens in run or setup modes.
DG	Function	Activates mode or action represented by the icon above each of the four buttons in the LCD.
DH	Up/Down	Move between drop-down fields, option boxes, and selectable values within Setup screens.
DJ	Setup Key Lock	Change ratio or enter Setup mode.
DR	USB Port	Connection for data download.

LEDs

There are four types of LEDs on the display.



Ref.	LED	Function
DK	Blue	Dosing valve active - On - dosing valve is active - Off - dosing valve is not active
DM	Green	Spray mode active - Spray mode is on (active) - Spray mode is off (inactive)
DN	Red	Alarm - On - alarm is present - Off - no alarm
DP	Yellow	Warning - On - is active. - Off - no warning indicated. Ratio and setup fields are not changeable. - Flashing - key is present and turned. Ratio and setup fields are changeable.

User Interface Display

Main Display Screen Components

NOTE: For detailed screens information, see **Appendix A - User Interface Display** beginning on page 66.

The following figure calls out the navigational, status, and general informational components of each display screen.

The system ratio mode shows if the mix ratio target is by volume  or weight . If the weight is crossed out, the system must be calibrated before running. See **Pump and Metering Test and Calibration for Ratio by Weight Mode** on page 47.

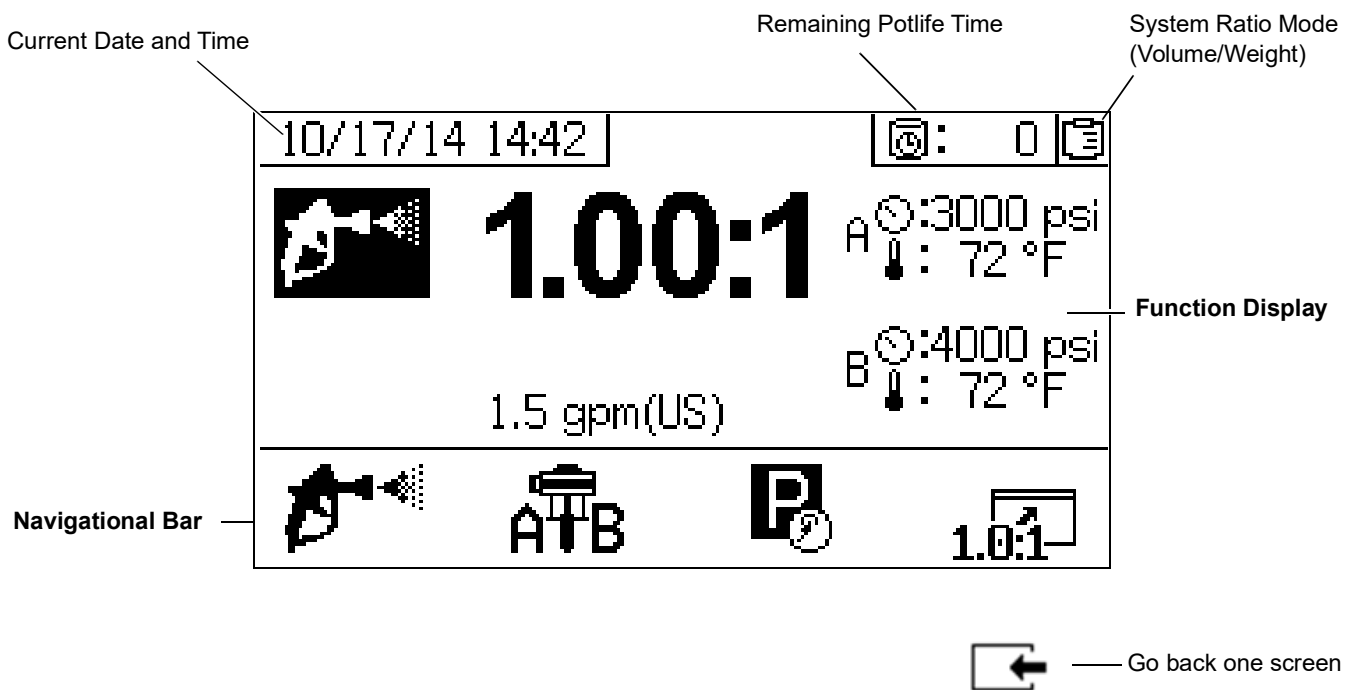

FIG. 8: Main Display Screen Components (shown with all display features enabled)

Setup

Location

Select a location that complies with the approval rating for your model. For approval rating, see **Models** on page 3.

The location must have the required power and air supply to set up your sprayer. See **Technical Specifications**, page 98, for Air Consumption and Power Requirements. Maintain access from all sides.

Unboxing

The machine is shipped on two separate pallets, one with the XM PFP and one with the two feed modules.

Each pallet is wrapped in heavy cardboard with a lid secured with straps. Cut the lid straps then remove the lids and cardboard.

Ratio Configuration

Proportioners leave the factory set up for materials which are higher volume and/or viscosity on the “A” side, and lower volume and/or viscosity on the “B” side. 1:1 mix ratio machines will normally change the “B” side circulation return hose from 3/8 in. to 1/2 in. ID to balance the recirculation speeds.

1:1 mix ratio machines also use outlet hose bundles which are 3/4 in. on both sides. The outlet fittings on the machine and the inlet fittings on the mix manifold must be changed on the “B” side from 1/2 in. to 3/4 in.

1:1 Ratio Adapter Kit 24X461 is provided with your machine. Install the kit, if necessary, before connecting the modules together.

Configuration Options

The system can be laid out two ways:

- Side by side: where the feed modules are on either side of the system module
- Front to back: where the feed modules are behind the system module

Front to Back Configuration

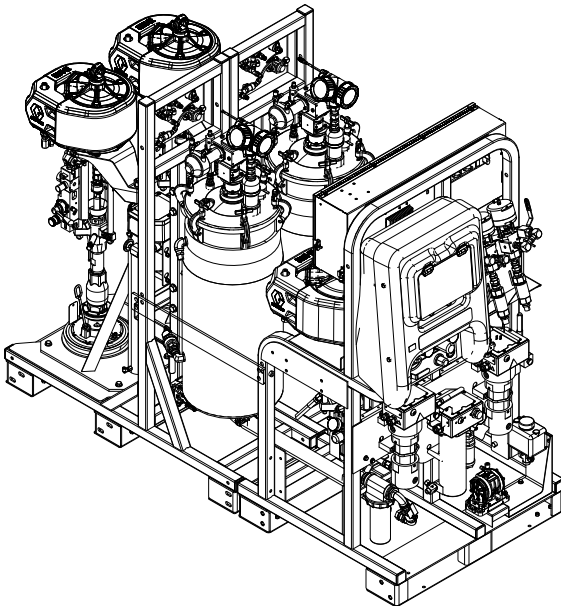

Side by Side Configuration

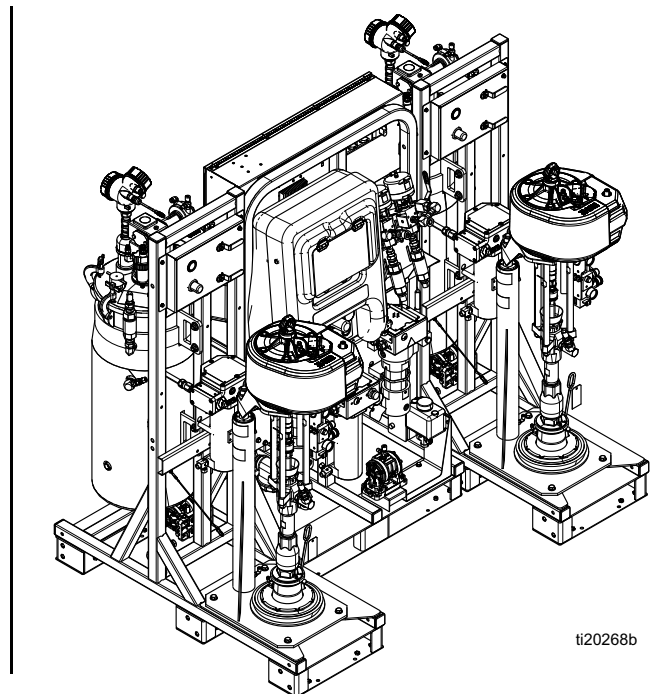

ti20268b

FIG. 9

Connect Modules

Regardless of the chosen module configuration, the A feed module must be on the left and the B feed module must be on the right when looking at the front of the system module. The A module has a blue A sticker on the air control panel and a 1/2 in. return fitting into the tanks. The B module has a green B sticker on the air control panel and a 3/8 in. return fitting into the tanks.

Frame Connection Parts

Part	Description	Qty
115211	SCREW, cap, hex head; 5.5 in	2
16J674	SCREW, cap, flange hd; 1.5 in	14
124869	SCREW, cap, hex head; 3.5 in	8
109570	WASHER	20
112731	NUT	10

Choose one of the configurations shown in FIG. 9 then bolt together the three modules on a flat surface. See FIG. 10 or FIG. 11 for bolt locations. The frame bolts are included in a bag. Once connected, the assembly can be moved as one piece with a fork-truck.

NOTICE

Do not use motor lift rings to lift the entire assembly. This will damage the system. The system must be lifted from the bottom.

If the modules will not be connected, they must be within 12 in. of each other and in one of the two configurations in FIG. 9 to ensure hoses and cables can reach their connections.

If the front-to-back module configuration is used, install the two supplied straight steel horizontal braces between each feed module and the sprayer module, see FIG. 11. These are not used in the side-by-side module configuration.

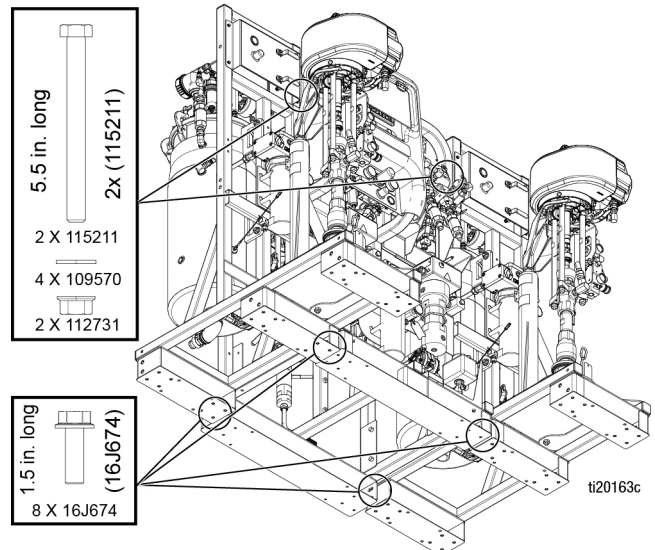

FIG. 10: Bolt Locations (Side by Side)

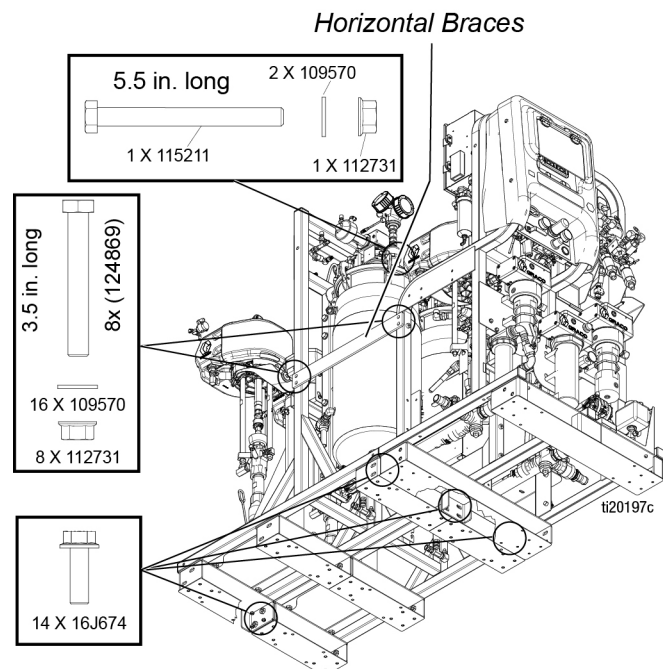
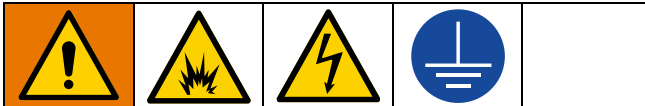

FIG. 11: Bolt Locations (Front to Back)

Grounding



The equipment must be grounded to reduce the risk of static sparking and electric shock. All internal earth grounding must use only copper wires. See electrical schematics in systems repair manual for wire size. Electric or static sparking can cause fumes to ignite or explode. Improper grounding can cause electric shock. Grounding provides an escape wire for the electric current.

All components shipped from the factory are electrically bonded through ground wires. Ground the electrical connection properly according to local codes.

Connect Power Cord



Power must be connected by a qualified electrician and comply with all local codes and regulations.

Graco does not supply junction box power supply cords. Use the following chart to determine which power cord your system requires.

Power Cord Requirements	
System Voltage	Cord Specification AWG (mm ²)
200-240 VAC, 3 PH	6 (13.3) 3 wire + ground
350-415 VAC, 3 PH	6 (13.3) 4 wire + ground

For Hazardous Location Models, use appropriate power cord. Follow all National, State, and Local electric codes.

- Open junction box cover.
- For non-hazardous location models,** Insert power cord through the large empty strain relief in the bottom of the junction box.

For hazardous location models, Insert power cord in the bottom of the explosion proof box. Use appropriate cable gland for the 1-1/4 npt port, the cable gland must be rated to EX II 2 G. Follow all National, State, and Local electric codes.
- Connect power cord as follows.

Non-Hazardous Location Models

200-240 VAC, 3 Phase Delta, Non-Hazardous

Location: Use a 5/32 in. (4 mm) hex key to connect the three power leads to top terminals L1, L2, and L3. Connect green to ground (GND).

350-415 VAC, 3 Phase WYE, Non-Hazardous

Location: Use a 5/32 in. (4 mm) hex key to connect the three power leads to the top terminals T4, L1, and L2. Connect neutral to L3. Connect green to ground (GND).

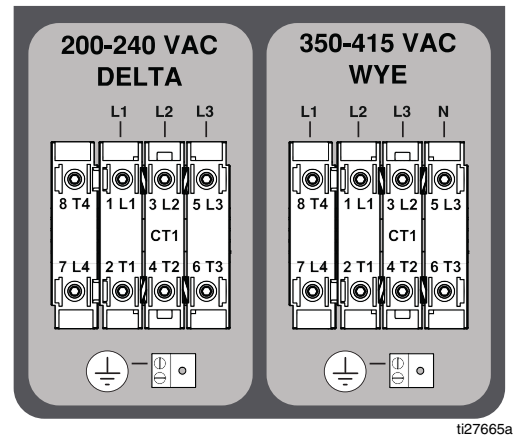

Hazardous Location Models

200-240 VAC, 3 Phase Delta, Hazardous Location:

Use a screwdriver to connect the three power leads to the left side of terminals TB3, TB4, and TB5. Connect green to ground (TB1).

350-415 VAC, 3 Phase WYE, Hazardous Location:

Use a screwdriver to connect the three power leads to the left side of terminals TB2, TB3, TB4, and TB5. Connect neutral to N. Connect green to ground (TB1).

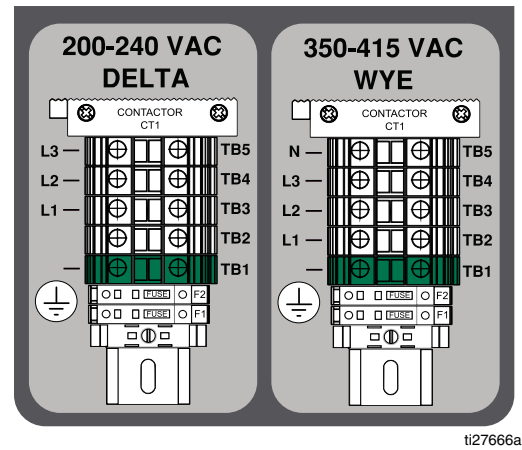

Set Power Jumpers

1. Find the red power jumpers for the terminal blocks supplied in a plastic bag in the circuit box. For hazardous location models, are in the explosion proof box (E1).
2. For 200-240 VAC and 350-415 VAC, 3 Phase installations only, use pliers to install the three red power jumpers into the terminal blocks in the correct positions as shown in the following illustration. Push jumpers firmly into position.

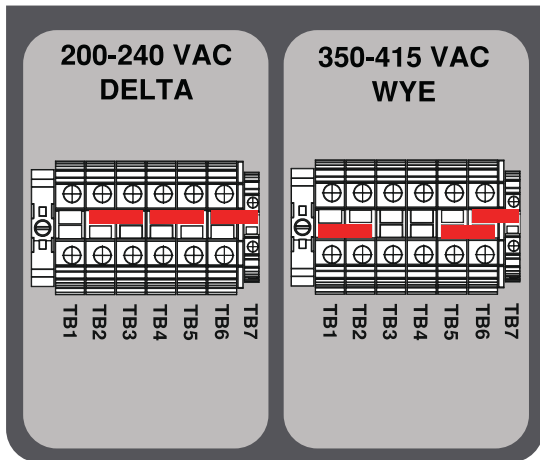

ti27667a

FIG. 12: Non-Hazardous Location Models

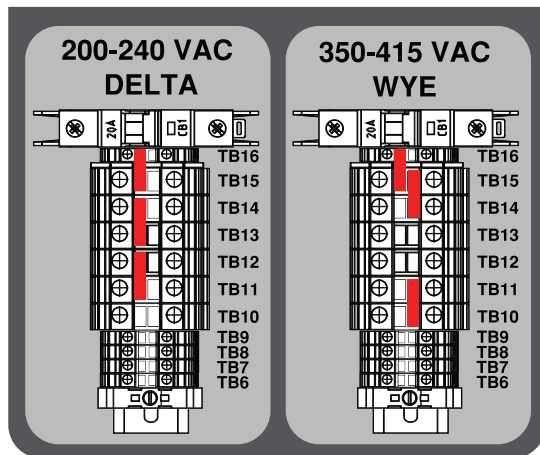

ti27668a

FIG. 13: Hazardous Location Models

3. Close junction box cover.

Connect Air Supply

Connect air supply line to the 1 in. npt(f) air supply ball valve inlet.

Use a 3/4 in. (19.1 mm) ID minimum air hose.

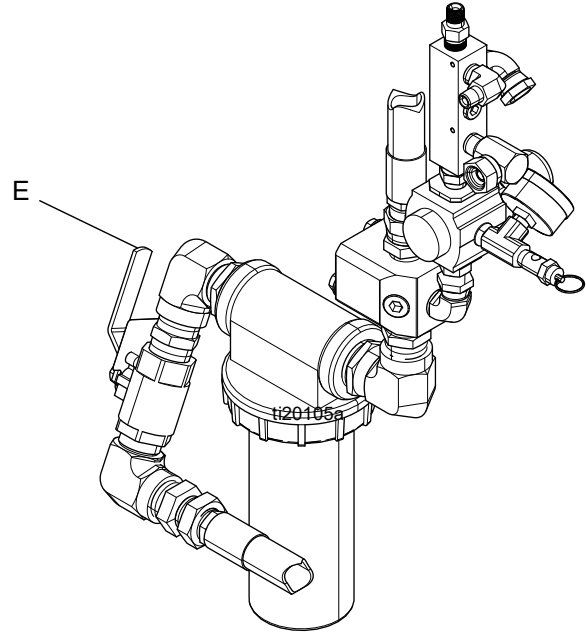

Air supply requirement: 150 psi (1.0 MPa, 10.3 bar) maximum; 80 psi (552 kPa, 5.5 bar) minimum (while running).

Flow volume required: 100 scfm (2.8 m³/min) minimum; 250 scfm (7.1 m³/min) maximum. Available fluid pressure and flow rate are directly related to available air volume. A typical single gun XM PFP application will use 125 to 175 scfm (3.5 to 5.0 m³/min).

Dosing valves are operated by air. The sprayer will not operate correctly if the inlet air pressure drops below 80 psi (552 kPa, 5.5 bar) while spraying.

Connect Feed Module Lines to Sprayer Module

1. **Connect Modules**, page 18.
2. Connect the large diameter green hose from each tank bottom outlet to the respective metering pump inlet. Hose (1403) is for side by side setup and hose (1413) is for front to back configurations.

NOTE: There is a vertical swivel union at each end of the green hose assembly.

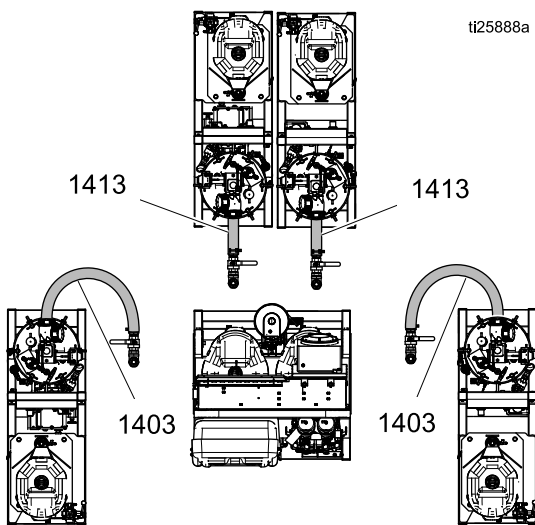

FIG. 14: Feed Module Lines

NOTE: If desired, the green hose can be trimmed to fit better.

- a. Loosen the tank end of the hose before trying to connect to the metering pump inlet.
- b. Bend the hose as necessary to make it fit.
- c. Once the vertical unions are tightened, check that the hose clamps on the green hose are tightened to approximately 90-100 in-lb (10-11 N•m).

3. Connect the two hose bundles with a red air hose on the sprayer module to the correct connection on the respective feed module, as described below.
 - a. Connect the red 1/2 in. air hose to the swivel union. See the 'a' in FIG. 15.

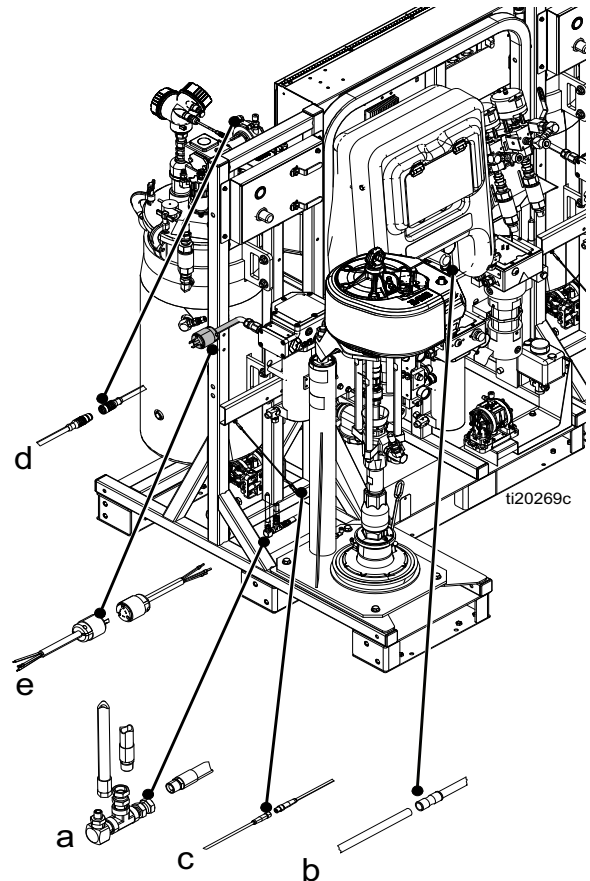

FIG. 15

- b. Connect the 1/4 in. OD air signal tube to the tube that has a tube connector. This is the feed pump pilot signal. See the 'b' in FIG. 15.
- c. Connect the small cable with an M8 connector to the mating M8 connector. See the 'c' in FIG. 15.
- d. Connect the larger cable with an M12 connector to the mating M12 connector. This is the level sensor connection. See the 'd' in FIG. 15.

- e. **For Non-Hazardous Location Models,** Connect heater power cables (e) for the tank heater and the flush heater. See FIG. 16.

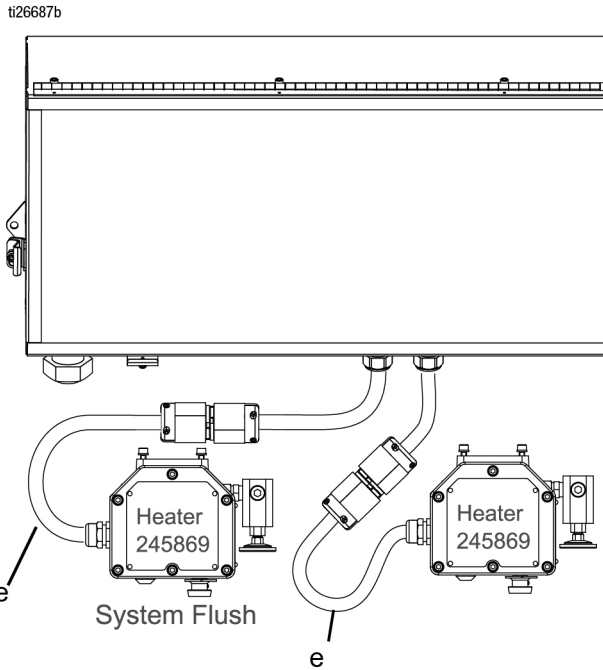

FIG. 16

- For Hazardous Location Models,** Connect heater power cables (e) for the tanks heater the flush heater to the terminal blocks. See FIG. 17.

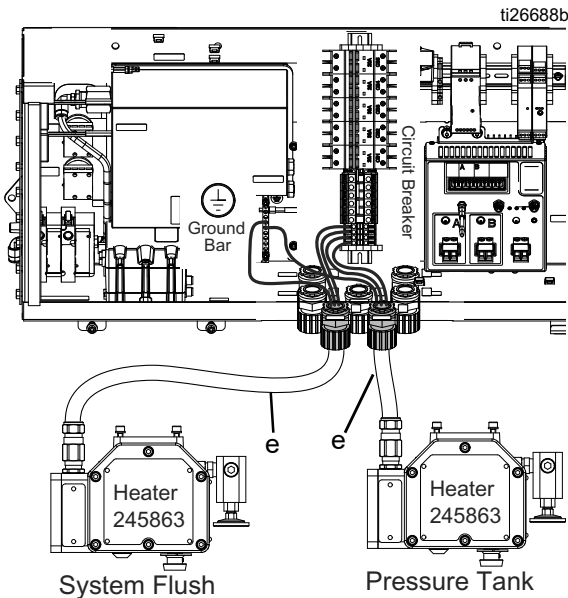

FIG. 17

4. Connect the fluid circulation return hoses.
 - The 1/2 in. circulation hose from the dosing valve connects to the side of the A tank.
 - The 3/8 in. circulation hose from the dosing valve connects to the side of the B tank.

Systems that will be used for 1:1 mix ratio materials need to change some fittings and circulation hoses. Use parts from kit 24X461 (supplied with your machine). See manual 334939 for instructions.

Install Level Sensor Probes

Each tank uses a 26.25 in. (67 cm) stainless steel rod, which functions as the level sensor probe, that mounts into the level sensor head and extends down into the tank. The level sensor probes are tie-wrapped to the frame of each feed module at the factory prior to shipment. The level sensor probes must be mounted into the level sensor heads before use.

1. Verify the main power switch is OFF.
2. Disconnect 3/4 in. union that holds the level sensor on top of the tank.
3. Apply blue thread lock to the threads in the top of the rod.
4. Feed the rod into the tank and screw the threaded end up into the sensor head.
5. Use a pliers to grab the flat on the rod and tighten the rod up into the sensor head. Do not over-tighten.

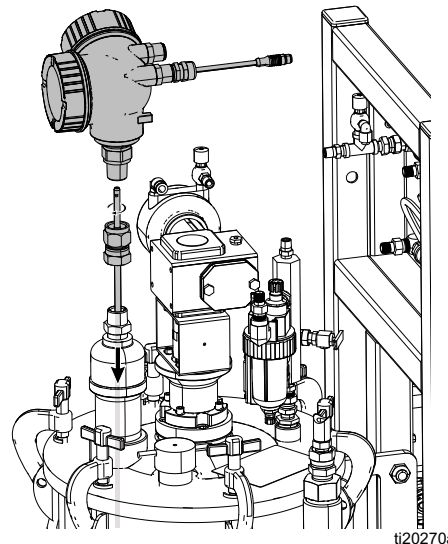

FIG. 18

Level Sensor Calibration

Level sensors are factory set to work with these tanks. Calibration is not necessary unless replacing a sensor. See repair manual for the XM PFP (3A2989).

Connect the Fluid Hose Bundle to the System

The system is shipped with a 50 ft (15 m) hose bundle for connecting the system to the mix manifold.

The bundle contains one 3/4 in. ID A material hose, one 1/2 in. ID B material hose (models 262869, 262898, or 262943) one 3/4 in. ID B material hose (models 24W626, 262945), one 1/4 in. ID flush hose, and 1/2 in. OD heated fluid circulation tubes. The hose bundle is insulated and wrapped inside a protective sheath which has a Velcro closure so it can be opened to change hoses.

For models 24W626 and 262945, use 1:1 Hose and Fitting kit 24X461 (supplied with your machine) to replace the fittings and B side circulation hoses. See supplied manual 334939 for instructions.

1. Position the hose bundle end with the four loose red and blue tubes at the machine outlet.

Systems 262869, 262898, and 262943: Connect the 3/4 in. A and 1/2 in. B hoses to the respective material outlet check valves on the front of the system. See FIG. 19.

Systems 24W626 and 262945: Connect the 3/4 in. A and 3/4 in. B hoses to the respective material outlet check valves on the front of the system. See FIG. 19.

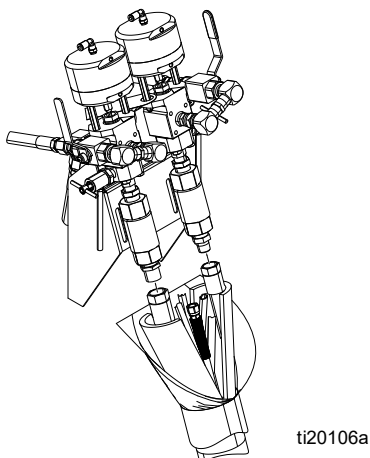

FIG. 19

2. Connect the short purple flush hose from the flush pump to the 1/4 npsm hose in the bundle. Use the 1/4 in. nipple included with the hose bundle to connect the hoses. See FIG. 20.

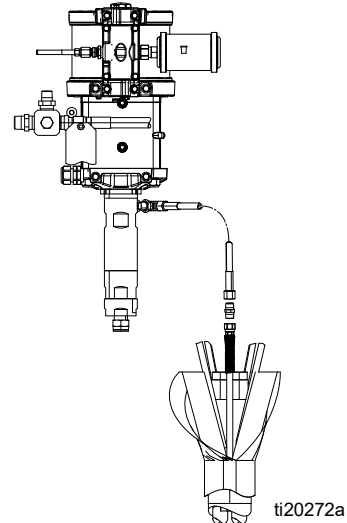

FIG. 20: Flush Pump Connection

3. Connect the two red tubes in the bundle to the tube tee on the red tube on the front of the machine. Do the same for the blue tubes. See FIG. 21.

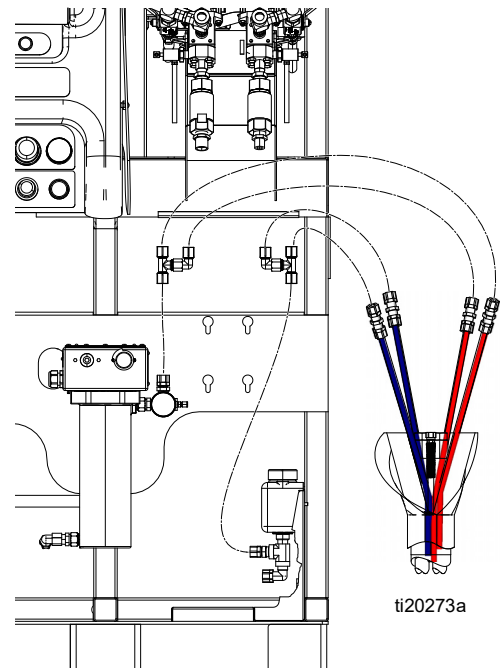

FIG. 21

4. Locate the temperature sensor with black heat shrink sheath and a connected cable that is tie-wrapped to the B heater power cable.
 - a. Cut the temperature sensor loose from the tie wrap.
 - b. Insert the sensor down inside the hose bundle so it is buried in the insulation and up against the fluid hoses. Be sure the sensor cable will not get pulled tight by the hose.

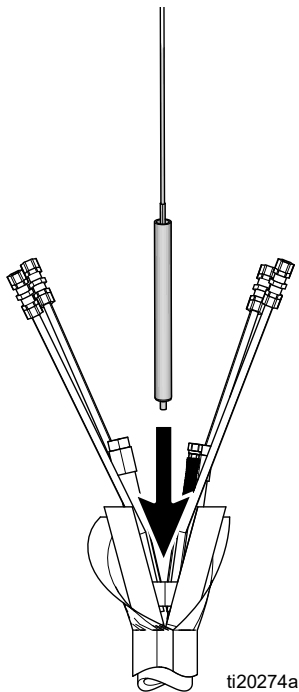

FIG. 22

- c. Use electrical tape to wrap the hose bundle from where it connects to the system to the hose sheath. This insulates and protects the hose bundle.

Connect the Fluid Hose Bundle to the Mix Manifold

1. Unroll the hose bundle out to the spray area.
2. **Systems 262869, 262898, and 262943:** Connect the 3/4 in. A and 1/2 in. B hoses to the material inlet ball valves on the mix manifold. See FIG. 23.

Systems 24W626 and 262945: Change the B side inlet nipple and connect the 3/4 in. A and 3/4 in. B hoses to the material inlet ball valves on the mix manifold. Color code material hoses (green and blue) with respective color identification on mix manifold. See FIG. 23.

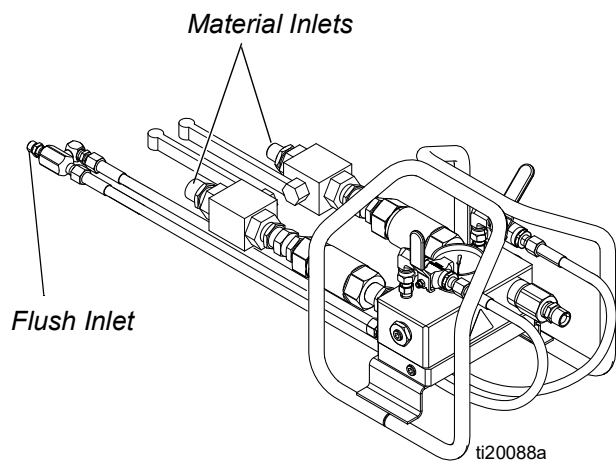

FIG. 23

3. Remove the U-shaped tube connectors only from the end of the longer set of red and blue tubes. Trim the excess tubing to fit the one set of the red and blue tubes fully into the two brass compression fittings on the aluminum heat circulation plate under the main manifold. Tighten the compression fittings.
4. Route the purple flush hoses from the manifold underneath the manifold carriage and connect to the 1/4 in. flush hose in the hose bundle. See FIG. 23.
5. Use electrical tape to wrap the hose bundle from where it connects to the system to the hose sheath. This insulates and protects the hose bundle.

Connect the Mix Manifold to the Gun

The following parts are supplied loose. Connect them to the mix manifold as follows. See FIG. 24.

1. Connect 1/2 in. ID x 2 ft hose to mix manifold (R) outlet.

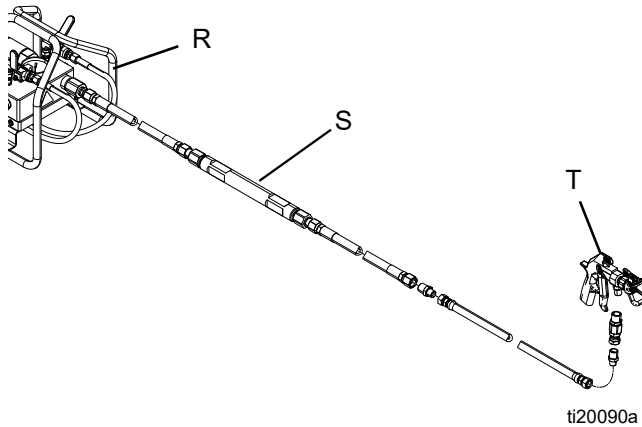

FIG. 24

2. Connect static mixer (S).
3. Connect 1/2 in. ID x 10 ft. hose.
4. Connect 1/2 in. x 3/8 in. nipple.
5. Connect 3/8 in. ID x 3 ft hose.
6. Connect 1/2 x 3/8 nipple.
7. Connect swivel.
8. Connect gun (T).

Connect Tank Heat Circulation Hoses

The tank jacket heat circulation system was pre-filled at the factory.

The tank to tank circulation hoses use quick-disconnect fittings that were disconnected and strapped to their own tank.

Unstrap these hoses and connect them back to the opposite tank as shown in FIG. 25 or FIG. 26.

Prime Heated Hose Bundle Fluid Circulation System

The heated fluid circulation system includes heated hoses alongside the material hoses for the length of the hose bundle, heated fluid circulation through the mix manifold, and heated fluid circulation through the tank double-wall which is insulated by a jacket.

See instructions on page 28.

Side By Side Configuration

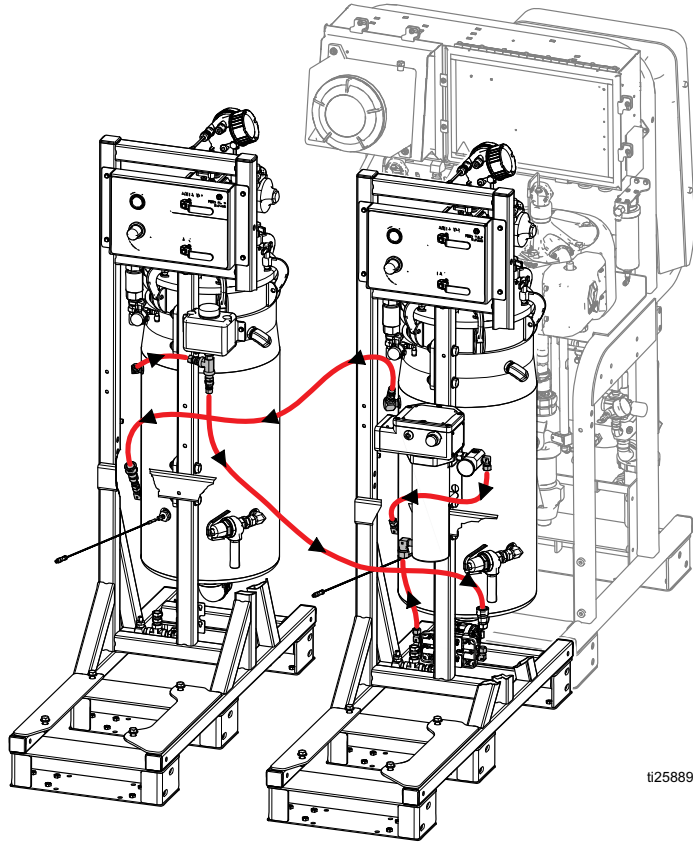

t25889b

See Front to Back Configuration, FIG. 4, page 12.

FIG. 25: Heated Fluid Diagram For Tank Heat

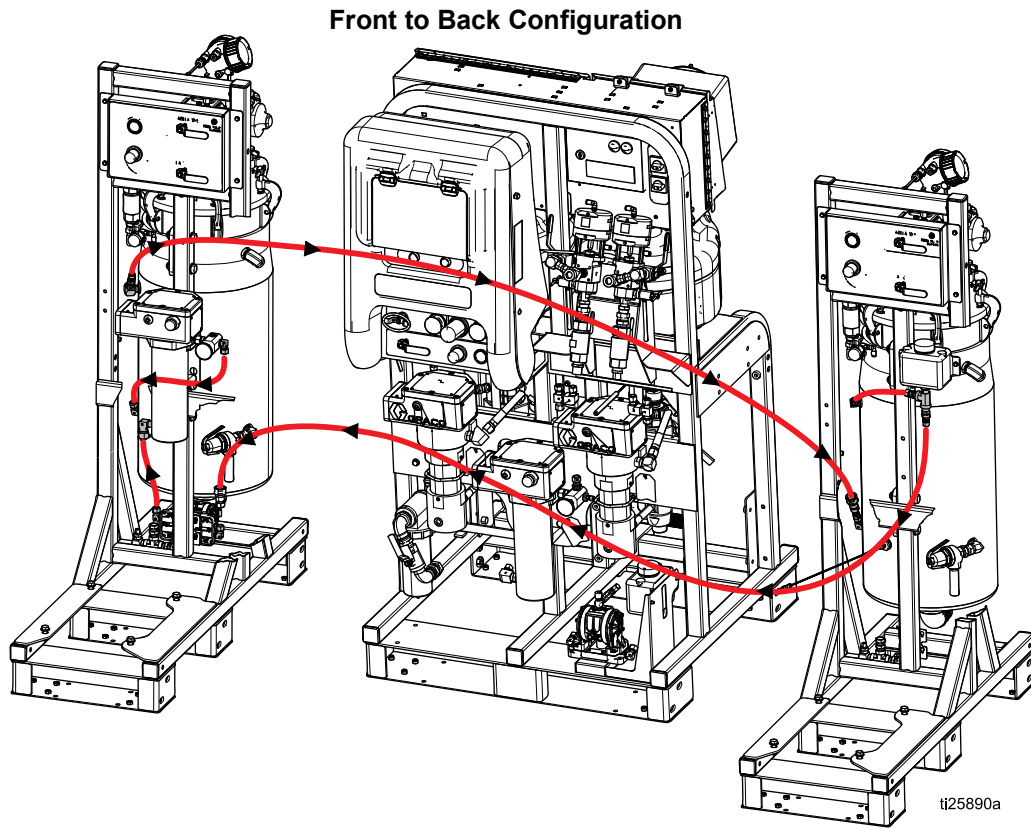

FIG. 26: Heated Fluid Diagram For Tank Heat (Hazardous Location Shown)

Prime Heated Fluid Circulation System Continued

Hose Bundle Heating System

1. Add a 50% water, 50% glycol anti-freeze mix to the small tank located at the bottom right corner of the front of the sprayer module.

NOTE: Even in warm climates, a water/glycol mix should be used to keep the circulation system clean and working properly.

2. With air supply on, adjust the silver knob on top of the diaphragm pump to start the small black diaphragm pump under the tank. Adjust pump to approximately 2-3 cycles per second.
3. Continue to add the 50/50 fluid mixture as air is purged from the fluid lines but make sure the tank is no more than 1/4 to 1/3 full when cold.

NOTE: Re-tighten all heated fluid circulation tube fittings after the first time the system has been run at full temperature.

Double-Walled Tank Heating System

NOTE: The double-walled tanks are pre-filled with a water/glycol mix at the factory. If your tanks are already filled, skip this section.

On all models, there is only one pump and one heater, which is located on the “A” side feed module.

1. Add a 50% water, 50% glycol anti-freeze mix to the small tank located between the tank and feed pump on the feed module.
2. Turn the agitator and tank heated fluid pump air ball valve (CT) ON.

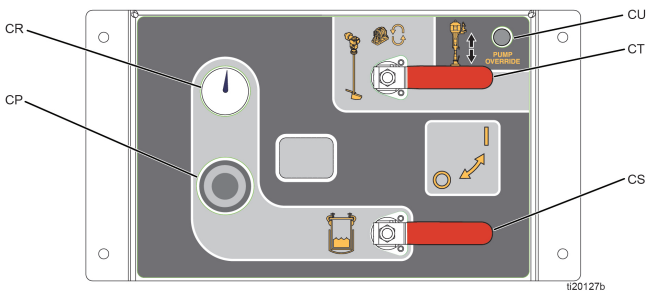

FIG. 27

3. Adjust the silver knob located just above the **Feed Module Air Controls**. When looking at the Feed Module Air Controls, the knob will be visible just above them. See FIG. 28. Adjust knob until tank heated fluid pump reaches approximately 2-3 cycles per second.

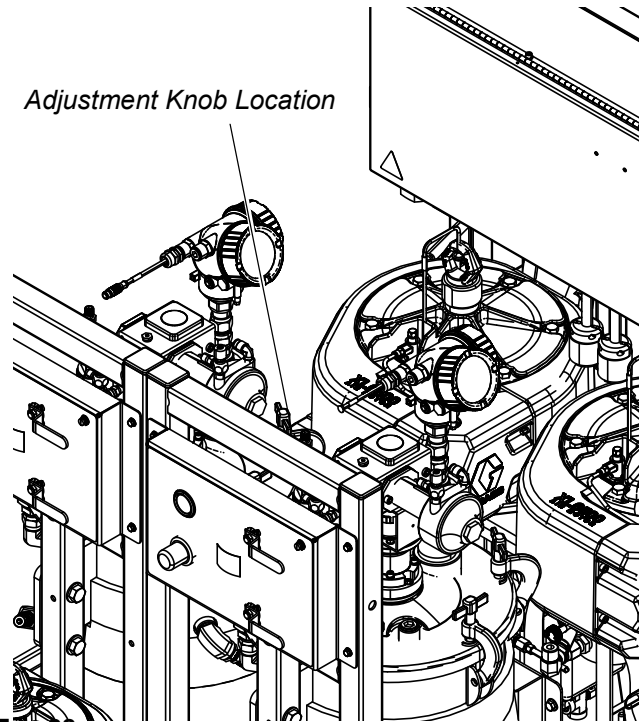
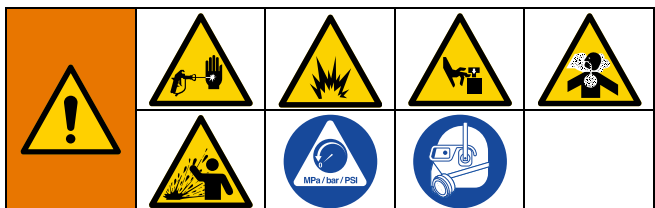

FIG. 28

4. Continue to add the 50/50 fluid mixture as air is purged from the fluid lines but make sure the tank is no more than 1/4 to 1/3 full when cold.

NOTE: Re-tighten all heated fluid circulation tube fittings after the first time the system has been run at full temperature.

Initial Startup



Perform this procedure on new systems. Systems are tested at the factory with mineral oil and there will be residual oil in the material lines. Flush new systems if A or B material will not function properly if it contacts mineral oil.

1. Verify all procedures in the **Setup** section beginning on page 17 have been properly performed.
2. Perform **Adjust Packing Nuts** on page 59.

Power On Machine

3. **For non-hazardous location models:** Turn main power switch (BA) ON and verify the system air inlet ball valve (E) is open. See FIG. 1 on page 9.

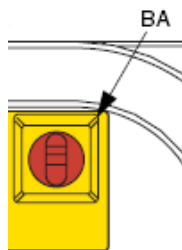

4. **For hazardous location models:**

- a. Open the air supply valve (E). See FIG. 1 on page 9.

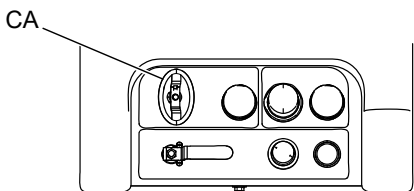

ti25891a

- b. Open the main power switch (CA). After approximately 5 seconds the left indicator light on the purge controller will turn green.
- c. While the system is in the purge sequence, wait approximately 3 minutes until the right indicator light turns green. The system display will turn on when the purge complete indicator turns green after a 3 minute purge sequence.

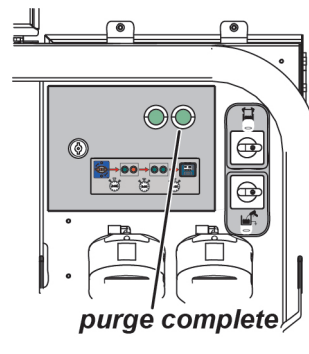

For hazardous location models, the system will turn off if the air is locked, turned off, or depressurized. Open the main power switch (CA) to turn on system and allow the purge controller to complete the 3 minute purge sequence.

Flush Machine (If Required)

5. *If your A or B material will not function properly if it mixes with a small amount of mineral oil, perform the remainder of this **Initial Startup** procedure once with grounded pails of solvent instead of A and B material pails. After performing this entire procedure once with solvent, perform it a second time with the A and B materials. Be sure to choose a solvent that is compatible with your material and with the wetted parts in this system. See **Technical Specifications** on page 98.*

Load Machine (First Time)

- Close both feed system air controls ball valves then open the brass valve on the tank lid air assembly. Air pressure gauge should read 0 psi. Close the brass valve.

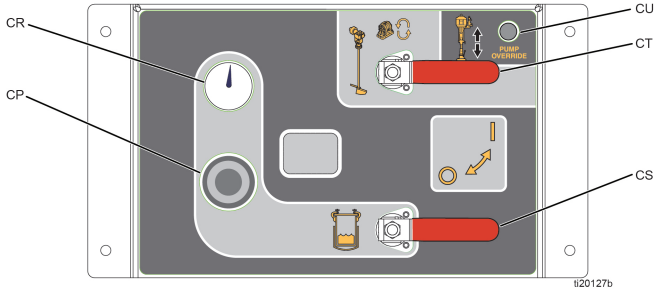

FIG. 29

- Disconnect the material circulation return line from the side of each tank then cap the tank port. This enables pushing the mineral oil out of the fluid lines. Route the return lines into waste containers. See FIG. 30.

NOTE: If the tank return lines are not disconnected on the initial priming of the system, all of the oil in the material lines will be pushed back into the tank and mixed with the material, which will contaminate all of the fluid in the tank.

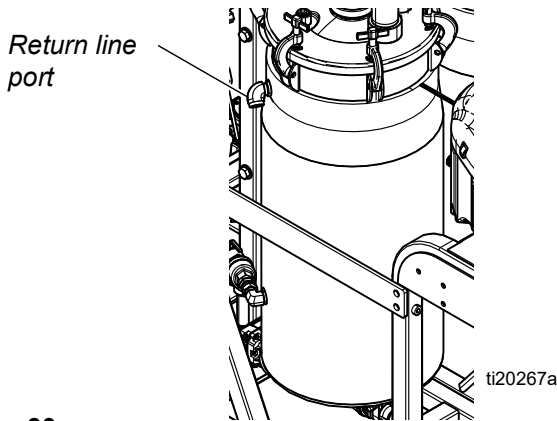



FIG. 30

- Fill the tanks with material:



NOTE: If adding flush solvent, remove the platen from the feed pump by loosening the two setscrews and the air tube. Drop the feed pump directly into the pail.

- Navigate to the Supply screen then press  to activate automatic tank filling. See page 82.
- Remove the priming stick from the platen.

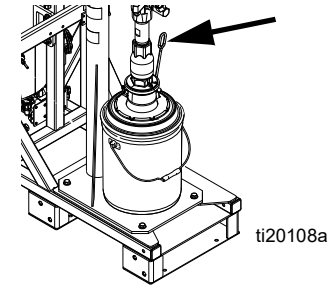

FIG. 31

- Slide main air slider valve (DA) and air motor slider valve (DF) to the OFF position. See FIG. 32.

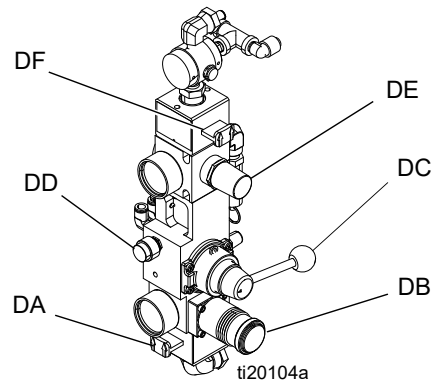

FIG. 32: Feed Pump Controls

- Back out the air regulator (DB) then lift the RAM director valve (DC).
- Slide main air slider valve (DA) ON.
- Slowly adjust the air regulator (DB) to increase air pressure until the RAM begins to lift. Use air regulator to adjust RAM speed.

- g. Adjust director valve to the neutral position when the platen is high enough to position the pail beneath the platen.
- h. Install pail of material beneath feed pump platen.

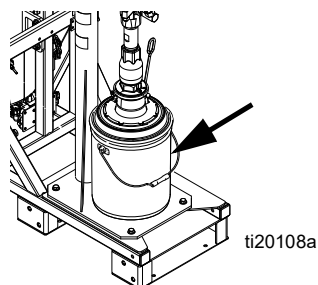
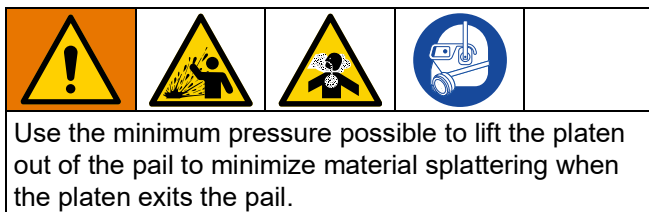

FIG. 33

- i. Back out the air regulator (DB) then lower the RAM director valve (DC).
- j. Slowly adjust the air regulator (DB) to increase air pressure until the RAM begins to lower. Use air regulator to adjust RAM speed.
- k. Ensure platen is centered on pail when it contacts it. Repeat previous steps until platen is centered on pail.
- l. Adjust air regulator (DB) to increase air pressure until the RAM presses into the pail. Install priming stick once fluid begins exiting the priming stick hole.

NOTE: New platen components may be stiff and resist entering the pail. Continue increasing pressure up to 80 psi until platen enters the pail. If it does not enter at 80 psi, the thick clear packing on the platen may need to be flipped upside down so the wider diameter side is up and the smaller diameter side is down.



- m. With the platen pressing into the fluid, slide the air motor slider valve (DF) to the ON position. See FIG. 32. Feed pump will start cycling. Continue pumping until pail is empty or desired amount of fluid has been added to the tank. Slide the air motor slider valve (DF) to the OFF position to stop the feed pump.

- n. To lift the platen out of the pail, press the blow-off valve (DD) then lift the director valve. The feed pump will push pressurized air into the pail to remove it from the platen. Do not let the pail lift off of the frame. If it does, lower the platen then retry.
- o. Repeat the previous steps as necessary until both tanks are filled to desired level. Do not overfill the tank.

- 9. Open both ball valves (CS, CT) on the feed module air controls.

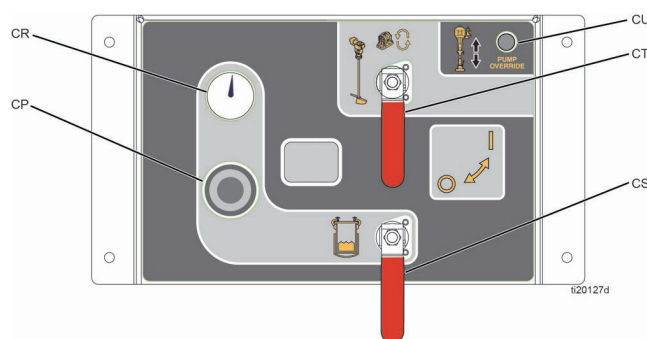
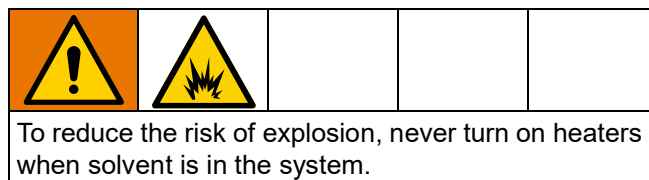
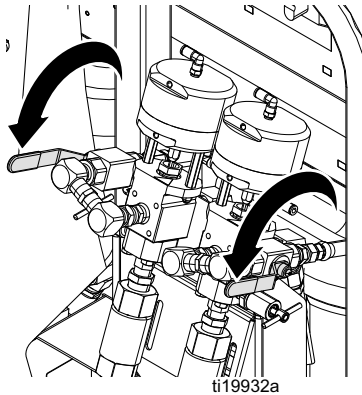

FIG. 34



- 10. If not already set, adjust the feed module settings:
 - a. Use regulator on the feed module air controls to set tank air pressure to 60 psi.
 - b. Adjust silver knob on agitator until it reaches 30 rpm.
 - c. Adjust silver knob on tank heated fluid circulation pump until it reaches 60 cpm.
 - d. *If there is no solvent in the tanks*, adjust tank water heater knob until the 4 is at the 12 o'clock position then check temperature when the heater indicator light turns off. Adjust setting then repeat until desired temperature is achieved.

11. Open the circulation valves.



12. Verify the sampling valves are closed.

13. Open metering pump inlet ball valves.

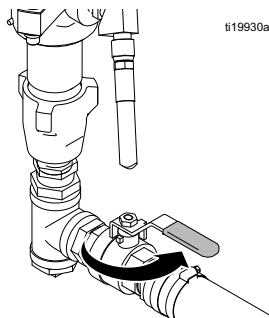

14. **For Non-Hazardous models:** Turn on air supply (CA) and set metering pump air regulator to 20 psi (138 kPa 1.38 bar).

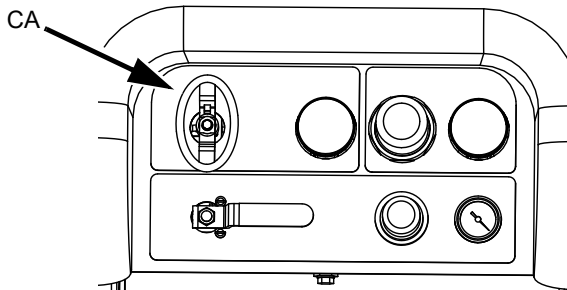

For hazardous location models, do not close the main power switch (CA). The system will turn off if the air is locked, turned off, or depressurized. Open the main power switch (CA) to turn on the system and allow the purge controller to complete the 3 minute purge sequence.

15. At the main run (fluid control) screen, press **ATB** to enter manual pump run mode.

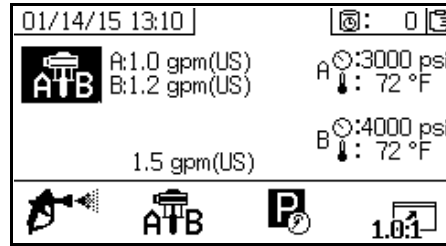

16. Press **ATB** repeatedly to select Metering Pump

A **ATB**. Press . Slowly turn metering pump air regulator (CD) clockwise to increase air pressure until metering pump A starts. Continue to run pump slowly and dispense into pail until clean material comes out of the return line. Press to stop pump. Back out the metering pump air regulator.

NOTICE

Run metering pump as slowly as possible until it is fully primed to prevent pump damage due to pump cavitation.

NOTE: To run each side independently, press **ATB** repeatedly to set to **AT_A** or **AT_B**. Press and as needed to prime. Monitor containers to avoid overflow.

NOTE: When priming or flushing pumps, it is normal to get cavitation or pump runaway alarms. Press to clear alarms then press again as necessary. These alarms prevent excessive pump speeds, which will damage pump packings.

17. Repeat the previous step for the B side.

NOTICE

Prior to performing the following step, make sure the tank is not more than half full. When the tank pressure is relieved the fluid will expand, overflow the tank, and damage system components if there is too much fluid in the tank.

18. Back out the tank air pressure regulator (CP) on the feed system air controls and open the brass valve on the tank lid.

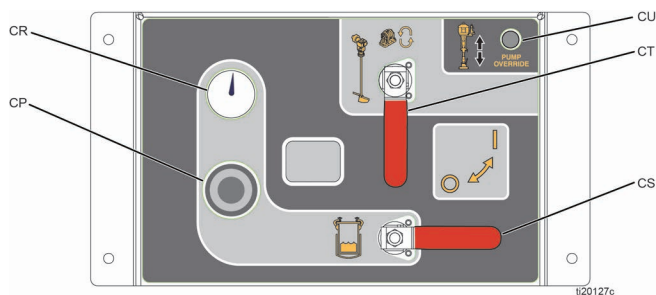
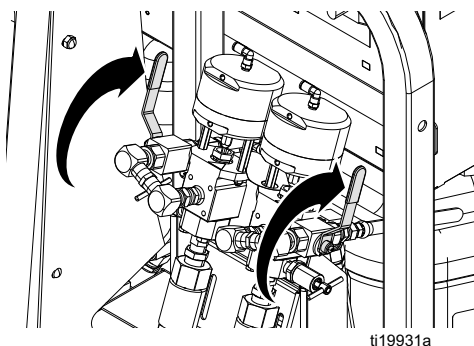



FIG. 35

19. With the tank air pressure relieved, remove tank port plugs and reconnect the tank return lines.
20. Adjust the tank air pressure regulator back to the desired pressure.
21. Close the circulation valves.



22. Prime the A sampling valve:

- a. Press **ATTB** repeatedly to set to **T_A**. Press . Slowly turn metering pump air regulator (CD) clockwise to increase air pressure until metering pump A starts.

- b. With a waste container beneath the valve, open the A sampling valve slowly until clean material dispenses then close the sampling valve.

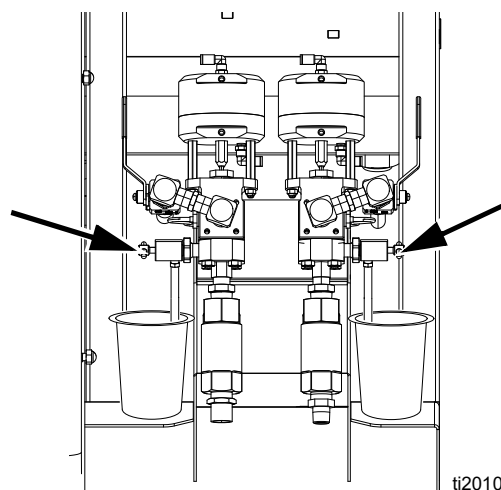



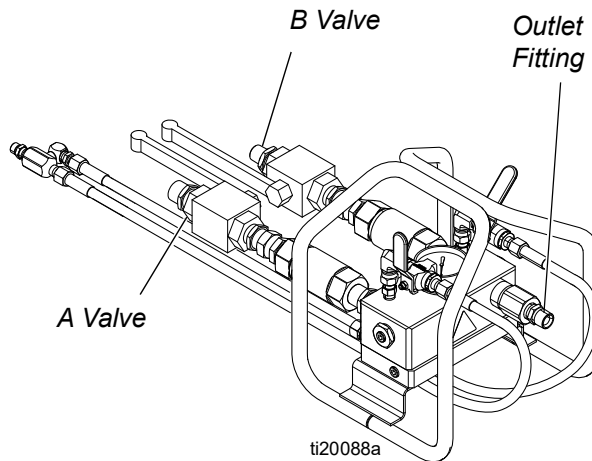

23. Repeat the previous step to prime the B sampling valve.

24. Prime the A material hose:

- a. Remove the outlet fitting from the mix manifold so materials can be dispensed without mixing.
- b. Place a waste pail under the mix manifold outlet.



c. Open the A side mix manifold inlet ball valve.

d. Press  repeatedly to set to . Press . Slowly turn metering pump air regulator (CD) clockwise to increase air pressure until metering pump A starts. Continue until clean material dispenses from the A material line then press  to stop pump.

e. Close the A side mix manifold inlet ball valve then reconnect to the mix manifold. Back out the metering pump air regulator.

f. Repeat for the B material line.

NOTE: Now all of the material lines are primed except for the section from the mix manifold to the gun.

25. Perform the **Prime Flush Pump** procedure on page 35 to flush out the oil from those lines, and to finish preparing for spraying.

Prime Flush Pump

Hazardous location models include the flush pump and a hot water supply kit. Hazardous location models can be setup to flush with either solvent or hot water.

Non-hazardous location systems only include a siphon flush pump meant for solvent pails. You can order the hot water flush kit accessory. See manual 332073 for complete hot water flush kit instructions.

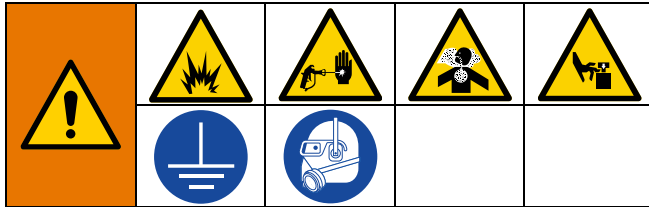

1. Turn main power switch ON and verify the XM PFP air supply ball valve is open.
2. Fill grounded metal pail with solvent.
3. With the mix manifold inlet ball valves and the mix manifold flush ball valves closed, trigger the gun into a grounded pail to remove any residual pressure.
4. Ensure trigger lock is engaged. Remove spray tip.

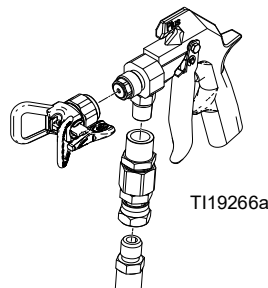
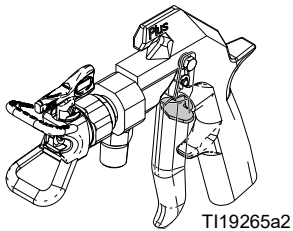

5. *If the hot water flush kit is not used*, place flush pump siphon tube in the pail of solvent.

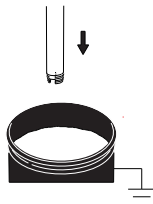

6. *If the optional hot water flush kit is used*, turn on the water hose connected to the water inlet. Do not turn on the water heater yet.

- a. Fill the tank.

- b. Be sure that the flush pump siphon hose pick up tube is latched in the water tank.
- c. Turn on the heated water circulation pump 1-2 cycle/second.

7. *If the hot water flush kit is used*, perform the following steps:

NOTICE

To avoid burning out the heater element in the water heater, never turn on the water heater unless it is filled with water.

- a. After water begins dispensing from the gun, turn the water heater knob to #6.
- b. Turn the water heater power switch (BD) on the system junction box ON.

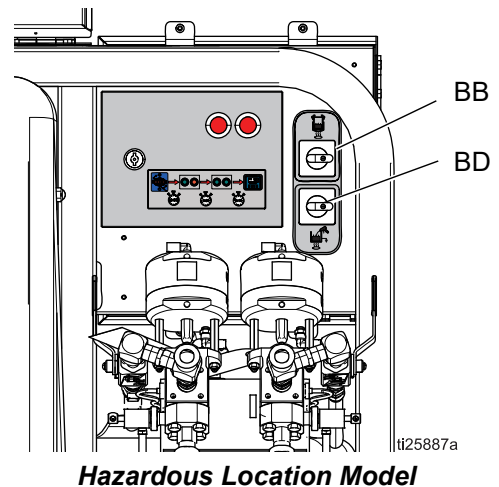
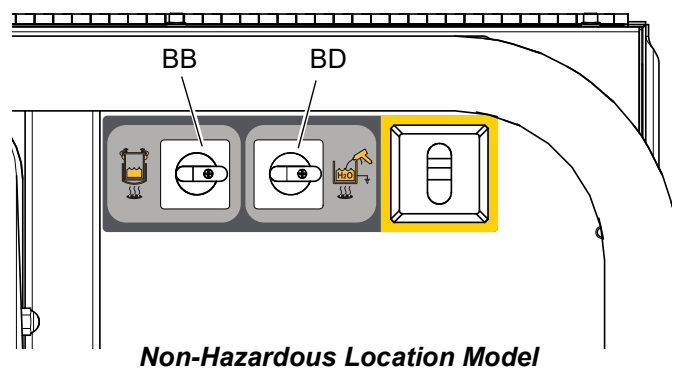

NOTE: The water heater must be filled with fluid and turned on at least 45 minutes prior to when flushing will be required.

Prime Flush Pump

8. Open the flush ball valves.

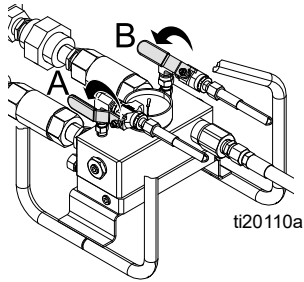

9. Disengage trigger lock and trigger gun into a grounded pail. Press gun against the grounded pail. Use a pail lid with a hole to dispense through. Seal around hole and gun with a rag to prevent splash back.

10. Open flush pump air valve (CB). Pull out and slowly turn flush pump air regulator (CG) clockwise until flush pump begins to slowly cycle.

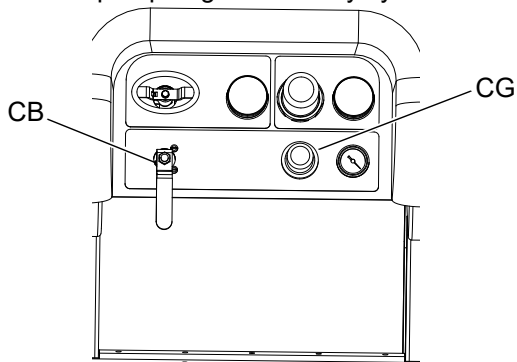

11. Continue to dispense until all air is purged.

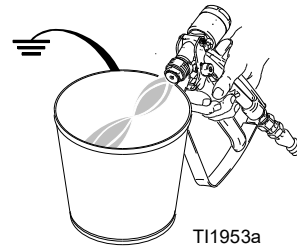

12. Close flush pump air valve (CB) to stop pump then trigger gun into grounded pail to relieve pressure. Engage gun trigger lock.

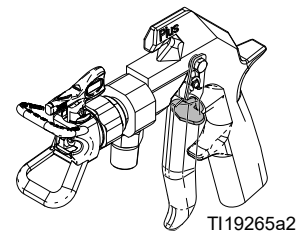

13. Close the flush ball valves on the mix manifold.

Adjust Ratio and System Settings

Verify Desired Ratio Mode



The machine can be run in either Ratio by Weight Mode or Ratio by Volume Mode. Since PFP materials are blended by weight, normally have air mixed in the fluids, and are checked by weight, it is recommended that these materials be run in Ratio by Weight Mode. This calibrates the machine to the exact materials that you are pumping, and gives the most accurate ratio checks by weight.

Ratio by Weight Mode is indicated by a balance scale in the upper right corner of the screen. Ratio by Volume Mode is indicated by a beaker in the upper right corner. The mode can be selected in the Enable Setup Screen 3. See **Enable Setup Screens**, page 71.

In Weight Mode, the scale in the upper right corner of the screen will have an X through it until the machine is calibrated, and a ratio check is complete. Spray Mode can not be used until the X is cleared from the scale by doing a Pump Test Calibration, and performing a Ratio Check. See **Batch Dispense or Ratio Test**, page 49.

If you are running Ratio by Volume Mode, the mix ratio by weight still needs to be set on the Ratio Test Setup Screen. This allows ratio checks to be done by weight. See **Appendix A, Ratio Test**, page 71.

Adjust Ratio Set Point

1. Turn key to right (setup position). Yellow LED will flash and the Setup mode Home screen will display.
2. Press  and  to change the volume or weight ratio setting. Current setting of volume or weight is shown in the upper right corner.
3. When desired ratio is displayed, turn key to left. Yellow LED will turn off.
4. Change all settings in the user-interface to the desired values. See **Appendix A - User Interface Display** on page 66 for detailed screens information, including navigation and instructions.

NOTE: High mix or viscosity ratio (greater than 3:1) materials may require adding restriction to the B side outlet.

Temperature Settings

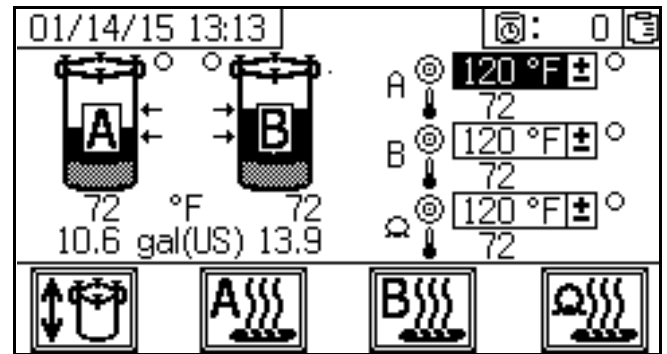

Set all temperatures per your materials data sheet specifications.

Feed Tanks

Temperature is controlled by an adjustable thermostat on the heater mounted on the "A" side feed module. Power to the tank heater is supplied from the power switch (BB) above the dosing valves. Tank material temperature is displayed on the Supply screen under the tank icon. The circulating heated fluid temperature is displayed on the temperature gauge next to the heater.

1. Set heater control knob to 4. This is approximately 120°F (49°C).
2. After the red light goes out, check the temperature on the gauge and adjust as needed to get desired temperature.



NOTE: Tank will not heat up faster by increasing the temperature setting.

A and B Material Temperature

There is one Viscon HF 5400 watt heater for heating each material while in circulation or while dispensing. These heaters are digitally controlled to your specific setpoint temperature.

The Supply screen controls and displays the setpoint and actual temperature.

Set the desired A and B temperature. The box next to the target is the setpoint. The number next to the thermometer is the actual temperature.

Press  and  to turn on the A and B primary heaters.

See **Spray** procedure for pre-heating procedure to use prior to spraying.

Hose Bundle Temperature

Set the desired hose bundle temperature on the supply screen.

Be sure the knob on the Viscon HP hose heater (the middle of the three heaters on the front of the system) is turned fully clockwise (full ON position). Always leave in the full ON position. Heater has a separate digital control module in the junction box.

The heater will heat the water/glycol mixture to 180°F (82°C) as needed until the hose bundle gets up to the desired temperature. It will then run at whatever temperature is required to maintain the hose setpoint temperature.

Press  to turn the hose bundle heater ON or OFF.

Spray



This procedure includes steps to ensure that any settled fillers are well-mixed with the material, the metering pump lines are fully primed, the metering pump check valves are operating smoothly, and materials are up to temperature prior to spraying the production surface.

When the temperatures displayed on the Supply screen reach operating temperature, the material is ready to spray.

After the first day of spraying follow **Pressure Relief Procedure**, page 45, then tighten packing nuts on pumps and dosing valves.

1. If this is the **Initial Startup** or if system components have been replaced, follow the **Initial Startup** procedure beginning on page 29.
2. Verify that the metering pump regulator (CD) is turned counterclockwise to 0 psi.
3. **For non-hazardous location models:** Turn the main power switch (BA) ON and verify the XM PFP air supply ball valve (E) is open. Open the pump air valve (CA).

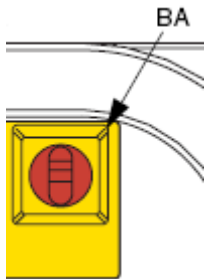

Non-Hazardous Location

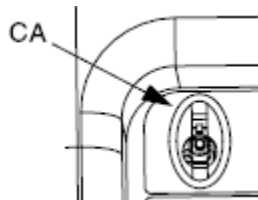

Hazardous Location

For hazardous location models: Turn the main power valve (CA) ON and verify the XM PFP air supply ball valve (E) is open.

4. Perform **Prime Flush Pump**, page 35 to ensure the flush pump is prepared to quickly flush out mixed material when done spraying.

NOTE: If the hot water flush kit is used, the water heater must be filled with fluid then turned on 45 minutes prior to when flushing will be required.

5. If tank levels are low, fill them with material. See step 8 on page 30.
6. Open both ball valves on the feed module air controls.

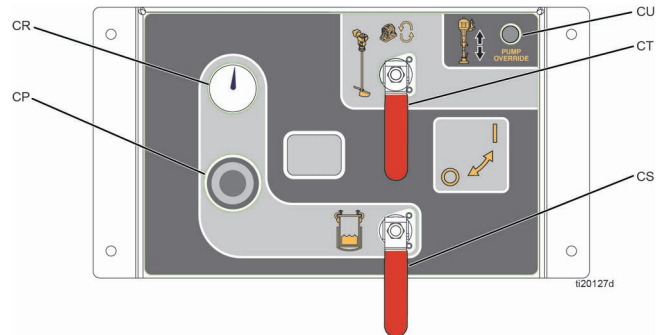
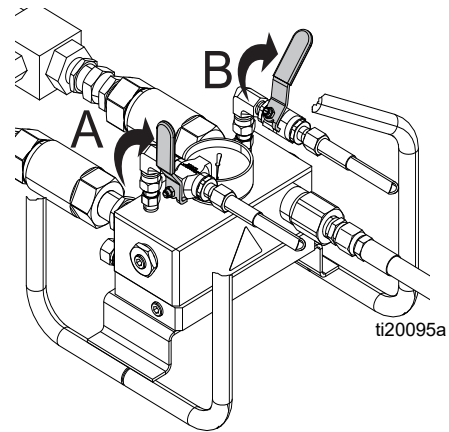
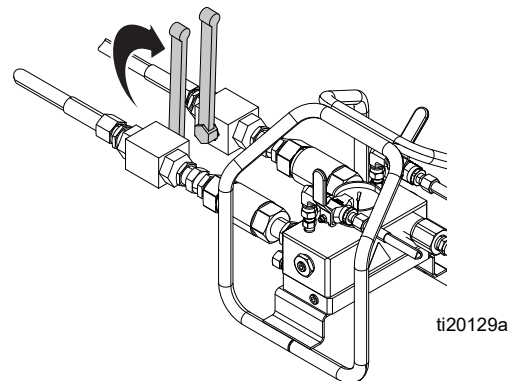

FIG. 36

7. Close mix manifold flush valves.



8. Close mix manifold ball valves.



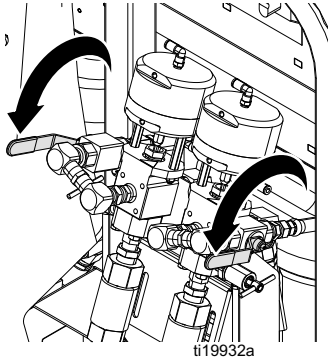

9. Open recirculation valves.





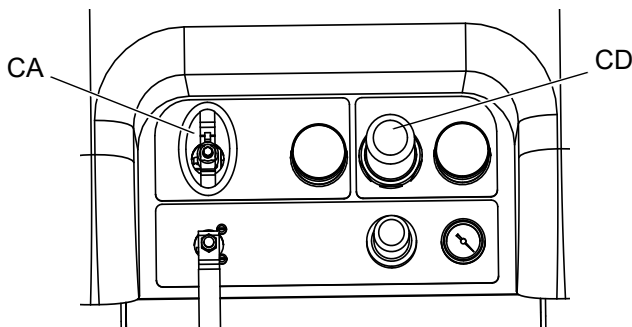

10. Ensure metering pump air regulator (CD) is turned counterclockwise to 0 psi.

For hazardous location models: do not turn off the main power switch (CA). If air is blocked, turned off, or depressurized, the system will turn off. To turn on system, open the main power switch (CA) and allow the 3 minute purge sequence to complete.

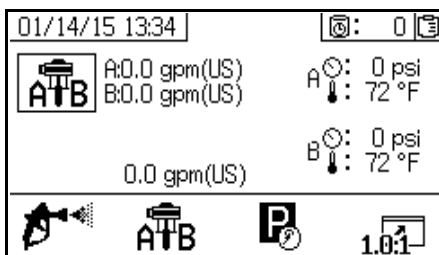

11. At the main run (fluid control) screen, press  to enter manual pump run mode.



12. Press  repeatedly to select . Press  to begin circulating.

NOTICE

Run metering pump as slowly as possible until it is fully primed to prevent pump damage due to pump cavitation.

13. Use metering pump air regulator (CD) to slowly increase the air pressure to the metering pumps until the enabled pump(s) begin running slowly.

For Hazardous Location Models: the system on/off valve is already open.

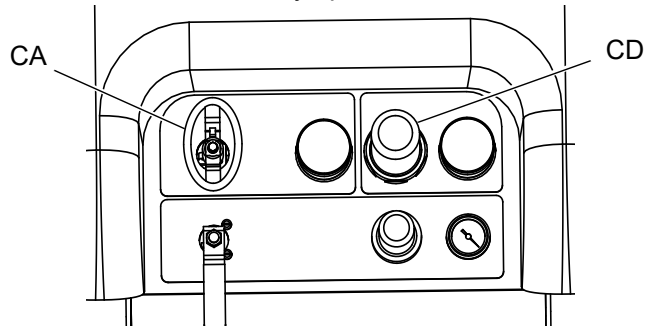

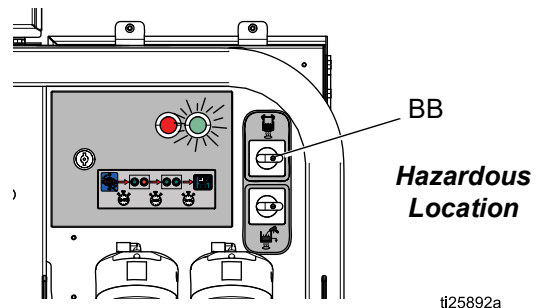
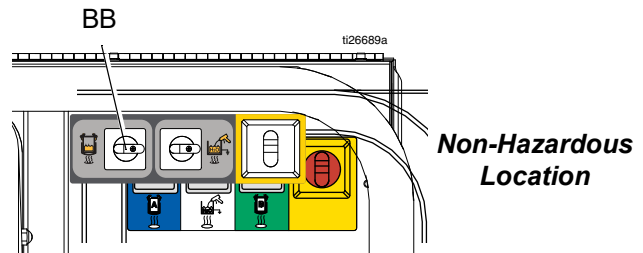

14. Turn A and B tank fluid heater (BB) ON if it isn't already ON.



15. To adjust tank fluid heater temperature, adjust the numbered knob on the heater.

16. Turn on the primary material heaters.

- a. Navigate to the Supply screen. See **Operator Command Mode Screens** on page 74.

- b. Press  and  to turn on the A and B primary heaters, and press  to turn on the hose bundle heater.

17. If desired, press  to enable automatic tank filling. See page 82 for automatic tank filling details.

18. Run the metering pumps until the material has reached the desired temperature.

NOTE: If you circulate the A side metering pump at pressures greater than 3000 psi (21 MPa, 210 bar), an advisory is issued and the yellow LED on the display illuminates. This is a reminder to select Spray mode prior to spraying and to circulate at a lower pressure to avoid excessive pump wear.

NOTE: If you circulate the A side metering pump above 5200 psi (35.4 MPa, 354 bar), an alarm shuts down the pump to prevent accidentally spraying material while still in circulation mode.

NOTE: If the circulation valves are closed while circulating, but the control is left in Circulation Mode, the machine will alarm after 5 seconds and exit Circulation Mode. This is done to prevent spraying in Circulation Mode.

19. Once the materials reach the desired temperature as shown on the supply screen, press .

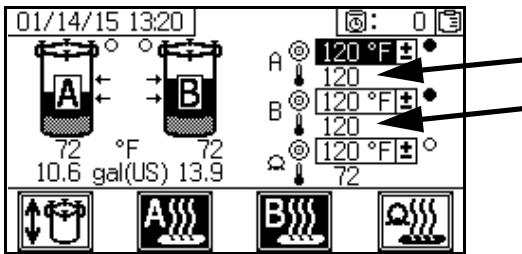

20. Turn the metering pump air regulator (CD) counterclockwise to 0 psi.

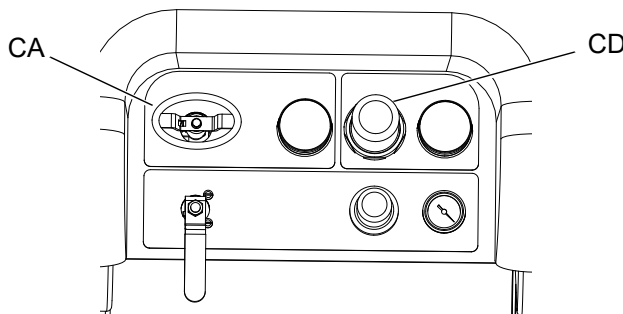

21. Close recirculation valves.

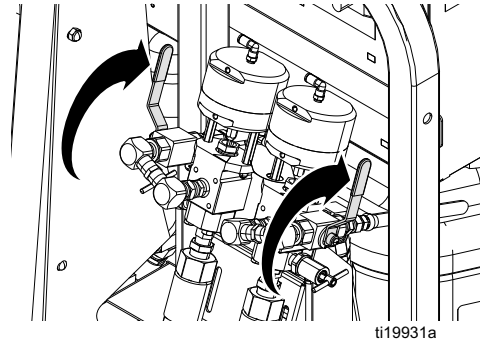

22. Perform **Pump and Metering Test and Calibration for Ratio by Weight Mode** on page 47.

23. Perform Ratio Test (**Batch Dispense or Ratio Test**) on page 49.

24. Perform **Down Stream Valve Leak Test** on page 51.

25. Open mix manifold ball valves.

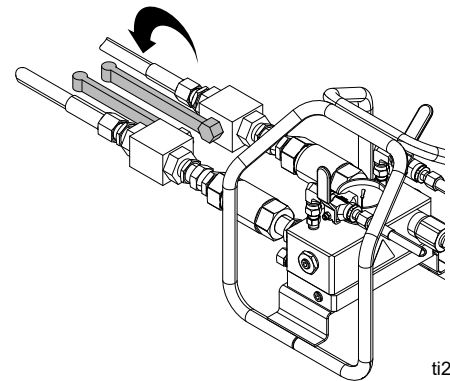

26. Select .

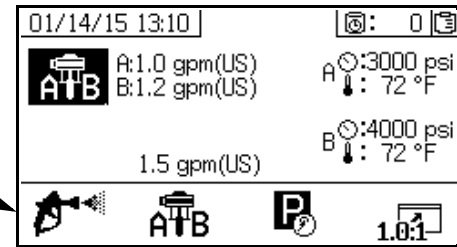

27. Press  to start the metering pumps.

Spray

28. Disengage trigger lock and trigger gun into a grounded metal pail. Use a metal pail lid with a hole to dispense through to avoid splashing.

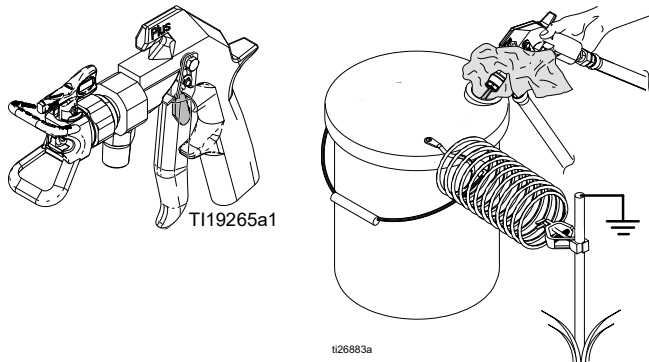

29. Adjust metering pump air regulator (CD) to 30 psi (0.21 MPa, 2.1 bar).

30. Dispense until clean, well-mixed epoxy flows from the gun.

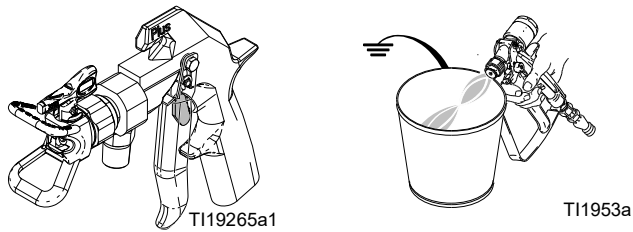

31. Engage trigger lock.

32. Perform the **Mix and Integration Tests** on page 52. When necessary, engage trigger lock (1) then install the tip (2) on gun.

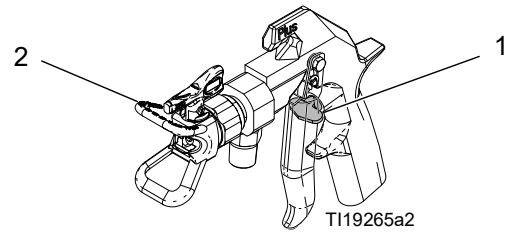

NOTE: While spraying, it is best to continuously hold the trigger. Do not release the trigger unless necessary. This maximizes the material temperature consistency and minimizes fiber buildup.

33. Adjust metering pump air regulator (CD) to the necessary spraying pressure and trigger gun to spray material on a test panel. Look at ratio screen to ensure it is reading the correct ratio. Continue spraying on the test panel until the desired pattern results then begin spraying the production surface.

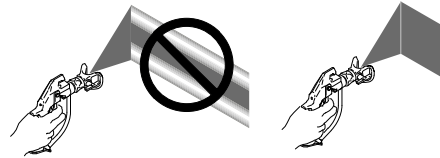

34. Follow **Flush Mixed Material** on page 43 when you are finished spraying if the potlife of the mixed materials in the system could expire before you spray again.

NOTE: Pot life of the mixed materials in the system is much shorter than the dry time of dispensed epoxy because mixed material potlife or working time decreases with increased temperature.

Flush Mixed Material

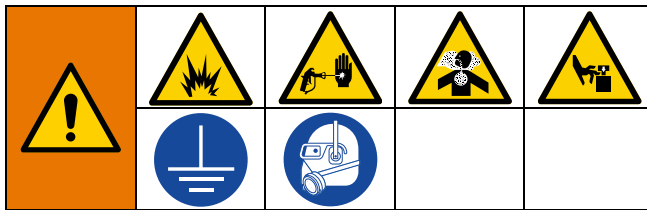

To avoid fire and explosion:

- Flush equipment only in a well-ventilated area
- Ensure main power is off and heater is cool before flushing
- Do not turn on heater until fluid lines are clear of solvent

This procedure flushes out mixed material from system to prevent it from curing in the system.

NOTE: Pot life of the mixed materials in the system is much shorter than the dry time of dispensed epoxy because mixed material potlife or working time decreases with increased temperature.

Follow this procedure when you are finished spraying if the potlife of the mixed materials in the system could expire before you spray again.

1. If necessary, **Prime Flush Pump**, page 35.
2. Press  to stop the metering pumps.
3. Trigger gun into a waste container to relieve pressure then engage trigger lock.
4. Remove spray tip.
5. Close mix manifold ball valves.

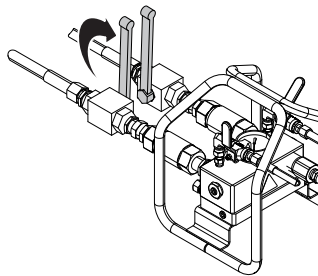

ti20129a

6. Open one of the flush ball valves on the mix manifold.
7. Disengage trigger lock and trigger gun into a grounded pail. Use a pail lid with a hole to dispense through. Seal around hole and gun with a rag to prevent splash back.
8. Open flush pump air supply valve (CB). Pull out and slowly turn flush pump air regulator (CG) clockwise to increase air pressure. Use lowest pressure needed to flush material out of hose.

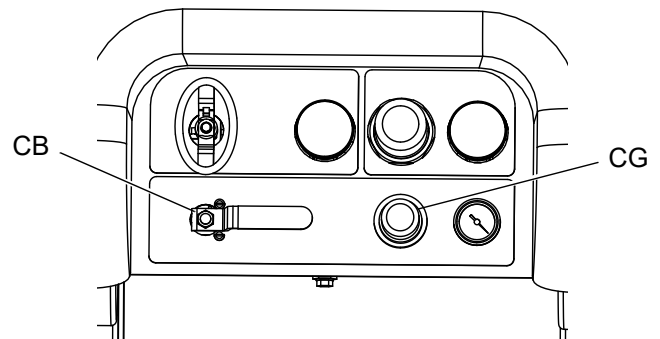

9. Continue dispensing until clean flushing fluid is dispensed.

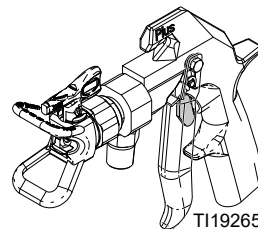

TI19265a1

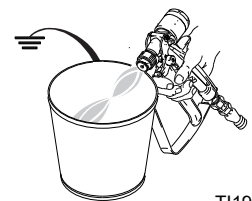

TI1953a

10. Close the open flush valve. Open the other flush valve. Continue dispensing long enough for any remaining mixed material
11. Close flush pump air supply valve.
12. Trigger gun to relieve pressure in flush lines then engage trigger lock.

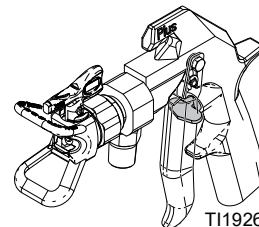

TI19265a2

13. Close flush ball valves.

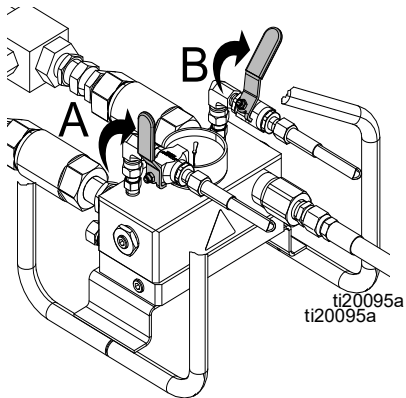

14. Use a rag and solvent to clean spray tip then reinstall on gun.

15. Remove the static mixer. Clean the mix element then re-install the mixer.

2. Open fluid recirculation valves.

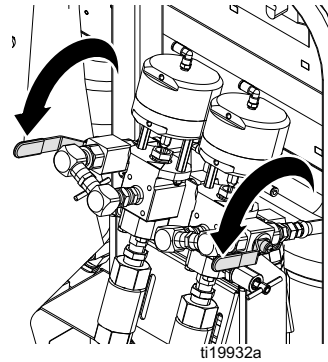

3. Close mix manifold material ball valves.

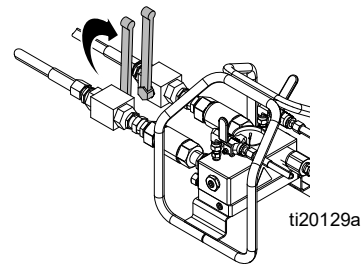

Park Metering Pump Rods



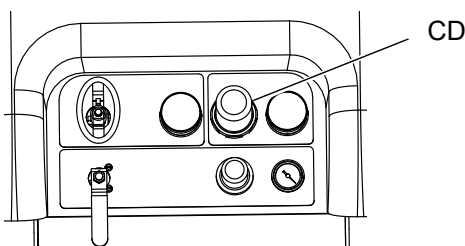

NOTE: This procedure is only necessary when the system will not be used for more than a few hours. The primary purpose of this procedure is to prevent material from hardening on the metering pump shaft by extending the pump so the portion of the shaft that is exposed to material is not exposed to the air.

1. Turn the metering pump air regulator (CD) counterclockwise to 0 psi.



4. Open the metering pump air supply ball valve.

5. Press  then press  to start metering pumps. Slowly adjust air pressure regulator until pumps begin to move. Each metering pump will circulate materials until they reach the bottom of the stroke then will stop.

6. Turn the metering pump air regulator (CD) counterclockwise to 0 psi

Pressure Relief Procedure



Important Safety Instructions

Read all warnings and instructions in this manual before using the equipment. Save these instructions.

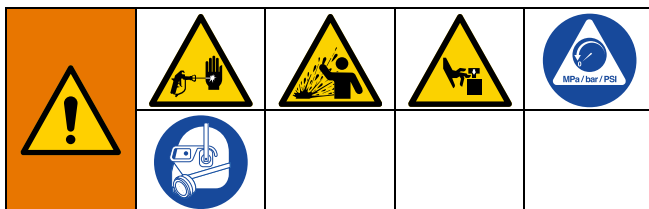

This equipment stays pressurized until pressure is manually relieved. To help prevent serious injury from pressurized fluid, such as skin injection, splashing fluid and moving parts, follow the Pressure Relief Procedure when you stop spraying and before cleaning, checking, or servicing the equipment.

1. Engage trigger lock.

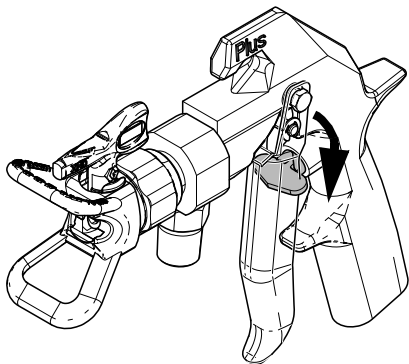

T119265a2

2. *If the system will be shut down for more than a few hours, perform **Park Metering Pump Rods** procedure on page 44 to prevent fluid hardening on the metering pump shafts.*

3. Press the stop button .

4. Slide the feed pump air supply valve (DF) and director valve air supply valve (DA) to the OFF position.

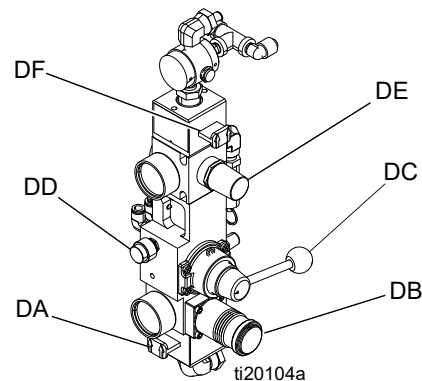

FIG. 37: Feed Pump Air Controls

NOTICE

The material may expand when air pressure is removed. This can cause the tank to overfill and damage the parts attached to the tank lid. To prevent overfilling the tank, never relieve air pressure in the tank unless the tank is less than half full. Verify tank material level on the user interface, see **Supply Screen**, page 82.

5. *If necessary to relieve tank air pressure:* close both feed system air control ball valves (CT, CS) and back out the air pressure regulator (CB). Open the brass valves on the tank lids for full tank de-pressurization. Pressure gauge (CR) should read 0 psi.

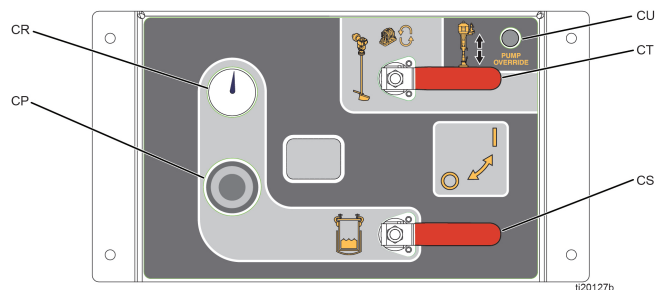
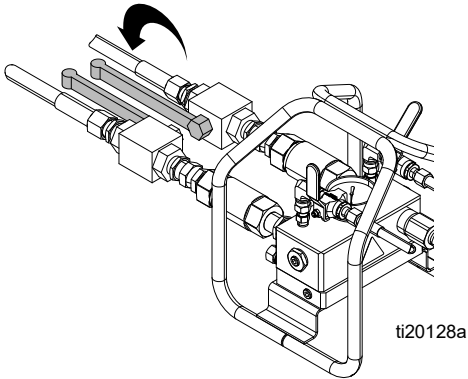

FIG. 38

Pressure Relief Procedure

6. Open mix manifold ball valves.



7. Open recirculation ball valves.

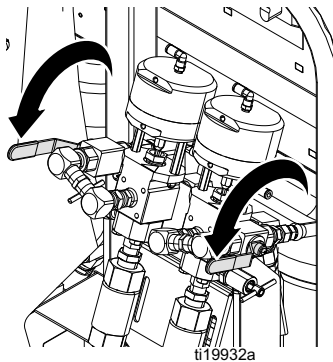

8. Disengage trigger lock.

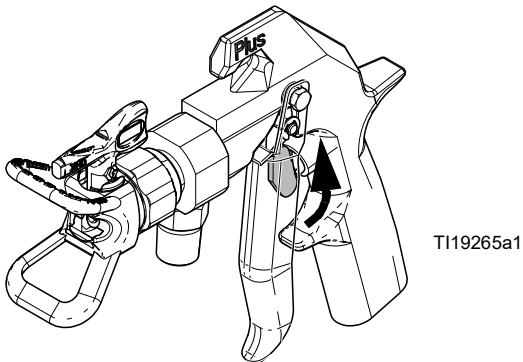

9. Hold a metal part of the gun firmly to a grounded metal pail. Trigger gun to relieve pressure in material hoses. Use a pail lid with a hole to dispense through. Seal around hole and gun with a rag to prevent splash back.

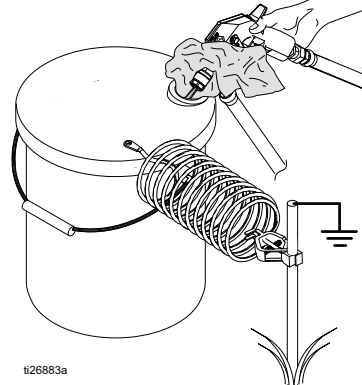

10. Engage trigger lock.

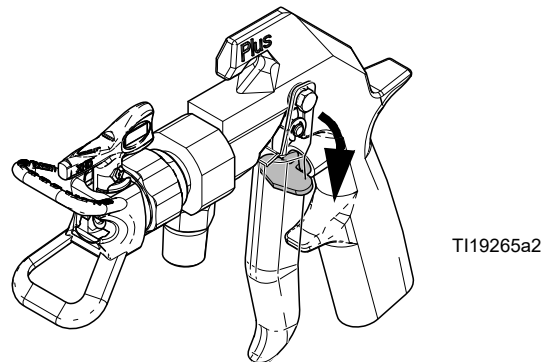

11. Close mix manifold material ball valves.

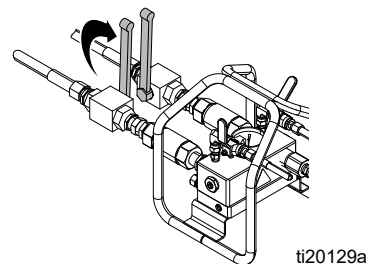

12. Perform **Flush Mixed Material** procedure beginning on page 43 to prevent mixed material curing in the system and to relieve pressure in the flush lines.
13. *If the system will be shutdown for more than a few hours, fill metering pump A and B packing nuts with throat seal liquid (TSL).*

NOTE: Fluid pressure in the system is now relieved.

System Verification



Pump and Metering Test and Calibration for Ratio by Weight Mode

This test checks the following five items and should be run every time a new job is started, or if there is a suspected problem.

- Verifies that the metering pumps installed match the metering pumps selected on the Setup screen by dispensing exactly 750 ml of each material.
- Verifies that each metering pump holds fluid against the metering pump inlet valve by stalling on the down stroke.
- Verifies that each metering pump holds fluid against the metering pump piston valve and packings by stalling on the upstroke.
- Verifies that each metering valve holds fluid and that there are no external leaks between the metering pump and metering valve.
- Verifies that the recirculation valves (AC, AD) are closed and do not leak.
- If system Ratio Mode is set by weight, this test calibrates the weight ratio. Ratio Mode by weight is the standard setting.

This test will dispense 750 ml of component A, and then 750 ml of component B. Dispense into separate cups so the fluid can be returned to the supply tanks.





NOTE: During each dispense the flow will stop once to stall the upstroke, once to stall the downstroke, and then it will finish the dispense. Do not close the sampling valve until the fluid flow stops and the blue metering pump light (DK) goes out.

NOTE: Material hoses from the system to the mix manifold must be filled with material and pressurized for testing to be successful.

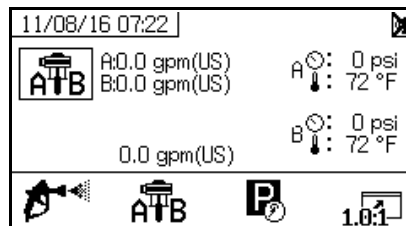
NOTE: Each sampling valve must be primed prior to beginning this procedure to ensure best accuracy. If the clear tube connected to the sampling valve is not filled with material, prime the sampling valves.

1. Verify the clear tube connected to each sampling valve is filled with material. If not, perform the following steps to ensure accuracy of the metering test.
 - a. Turn metering pump air supply valve on.
 - b. At the main run (fluid control) screen, press  to enter manual pump run mode.



- c. Press  repeatedly to select . Press .
- d. With a waste container beneath the sampling valve, slowly open the valve until material begins to slowly dispense. Once clean material dispenses from the sampling valve, and the clear tube is completely filled with clean material, press  to stop dispensing. Repeat with the other side if necessary.

2. Enter **Test Screens** (see page 77).

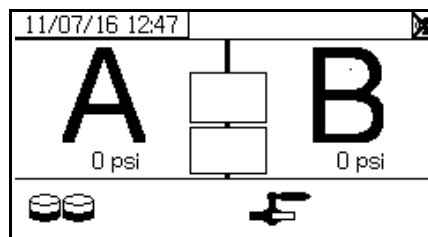

3. Select  to run pump test.

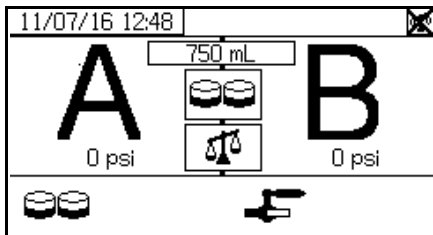

NOTE: These instructions show running the system with ratio control by weight, which is standard and preferred for XM PFP systems. To control ratio by volume, see **Test Screens** (page 77).

4. Set metering pump air regulator (CD) pressure to zero. Verify metering pump air valve (CA) is open (horizontal). Adjust metering pump air regulator (CD) pressure to 50 psi (0.35 MPa, 3.5 bar).

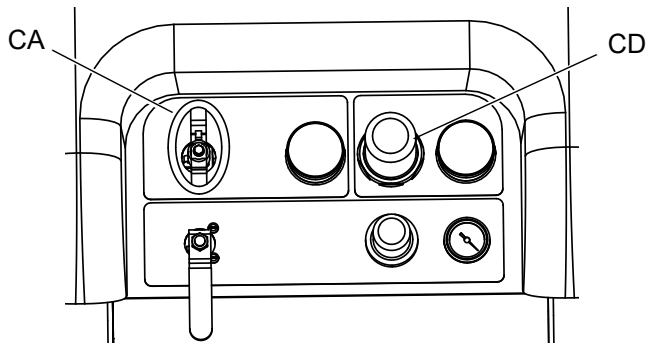

5. Dispense fluid A:
 - a. Close recirculation valves, mix manifold inlet ball valves, and sampling valves.
 - b. Tare and place a clean 1 quart (1000 cc) container under sampling valve A.

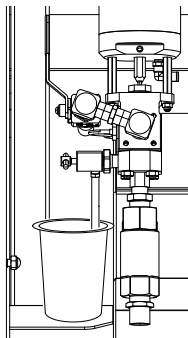

ti20111a

- c. Press . Metering pump A light (DK) comes on.
 - d. Slowly open sampling valve A until material begins to dispense. Metering pump stops automatically; twice during test and again when dispense completes. Metering pump A light (DK) turns off, metering pump B light (DK) turns on.
 - e. Close sampling valve A (AE).
6. Dispense fluid B as follows:
 - a. Tare and place a clean 1 quart (1000 cc) container under sampling valve B.

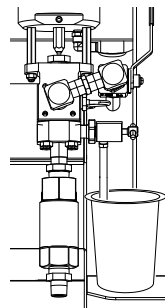

ti20112a

- b. Slowly open and adjust sampling valve B to achieve desired flow. Metering pump stops automatically; twice during test and again when dispense completes. Metering pump B light (DK) turns off.
 - c. Close sampling valve B.
7. Weigh the two samples with a gram scale and record the net weights.
 8. Return fluid used in test to corresponding fluid supply container.

Confirm Pump and Metering Test

The Confirm Pump and Metering Test screen displays when the pump and metering test completes without error. The screen displays the target weight of material dispensed into each beaker from each metering pump. The weights must be entered in grams to calibrate the machine.

Calibration is not finished until a successful Ratio Test is performed. See **Batch Dispense or Ratio Test**, page 49.

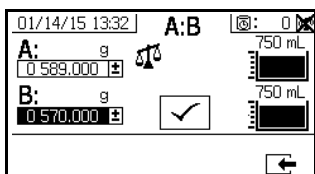

**System Ratio Mode
by Weight**

Batch Dispense or Ratio Test

This test dispenses a calculated volume of each fluid based on ratio. The two fluids combined equal the batch size selected.

Graco recommends running the following tests daily prior to spraying on the production surface.

Follow this procedure to dispense a batch (into one container) for touch-up work or to verify the dispensed ratio (use separate containers for fluids A and B).

When checking the ratio, use a gram scale to tare the two containers then weigh the dispensed materials.

1. Close mix manifold material ball valves.

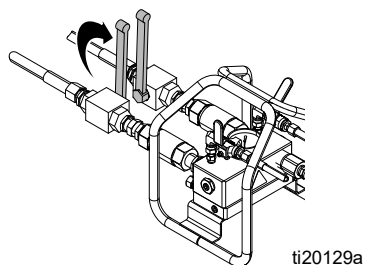

ti20129a

2. Close recirculation ball valves.

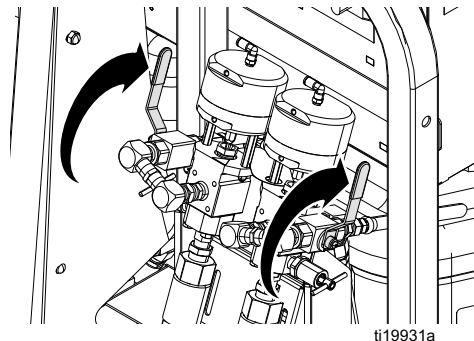

ti19931a

3. Pressurize the material lines:
 - d. Set metering pump air regulator (CD) pressure to 0 psi. Verify metering pump air valve (CA) is open.

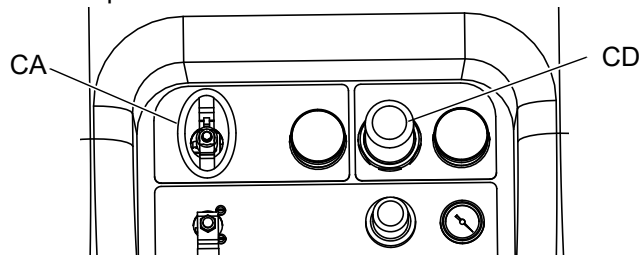

- e. At the main run (fluid control) screen, press **ATB** to enter manual pump run mode.

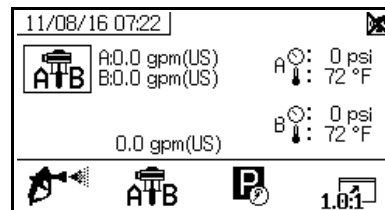

- f. Adjust metering pump air regulator (CD) pressure to 50 psi (0.35 MPa, 3.5 bar).

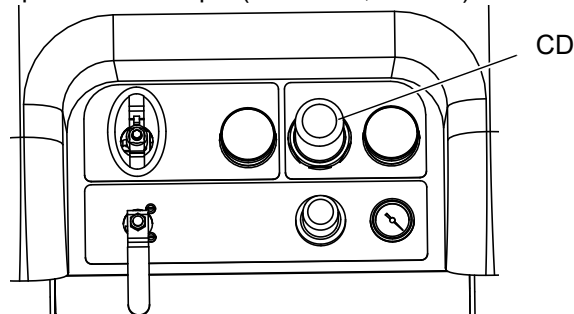

- g. Press .



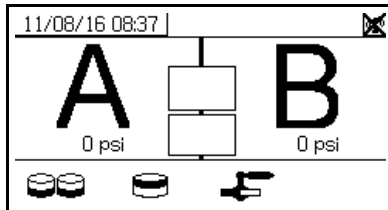

- h. When both the A and B metering pumps stall, press .

4. Enter **Test Screens** (page 77).

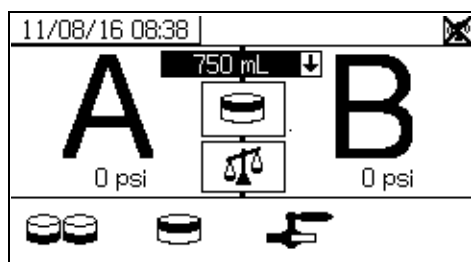

5. Select  to run batch dispense test.



6. Adjust dispense amounts from 500 ml to 2000 ml (in 250 ml increments) by pressing  to open the drop-down box. Then press  and  to select the desired value. Press  to select that value.
7. Close recirculation valves, mix manifold inlet ball valves, and sampling valves.
8. Place a clean container under sampling valve A.

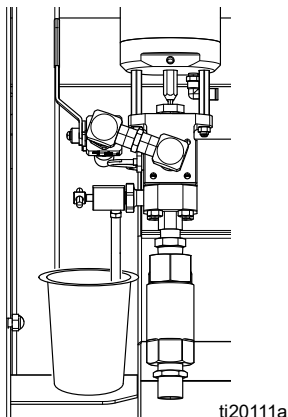

9. Press . Wait until the Metering pump A light comes on.
10. Dispense fluid A. Slowly open and adjust sampling valve A (AE) to achieve desired flow. The metering pump stops automatically when dispense completes and metering pump A light (DK) turns off and metering pump B light (DK) turns on.

11. Close sampling valve A (AE).

12. Dispense fluid B as follows:

- a. *Batch dispense:* move container under sampling valve B (AF).

Ratio check: place clean container under sampling valve B (AF).

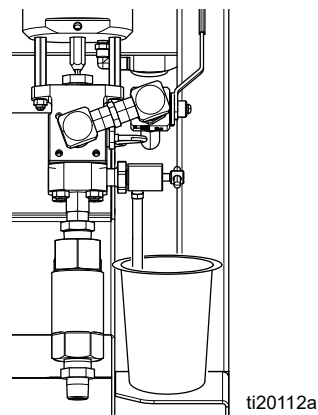

- b. Slowly open and adjust sampling valve B (AF) to achieve desired flow. The metering pump stops automatically when dispense completes. Metering pump B light (DK) turns off.
- c. Close sampling valve B (AF).
13. *Batch dispense:* stir material until mixed.
Ratio check: compare net weight of A and B materials dispensed.

Confirm Batch Dispense Test

The Confirm Batch Dispense Test screen displays when the batch dispense test completes without error. This screen displays the selected ratio between the metering pumps and the weight of material dispensed from each metering pump.

The gray at the bottom of the beaker represents the weight of material dispensed by metering pump A and the black at the top of the beaker represents the weight of material dispensed by pump B.

Enter the weight (in grams) of each sample in the A and B input boxes. The system will calculate the ratio and display a check in the box if it is within tolerance. The result of the test is also entered in the USB log.

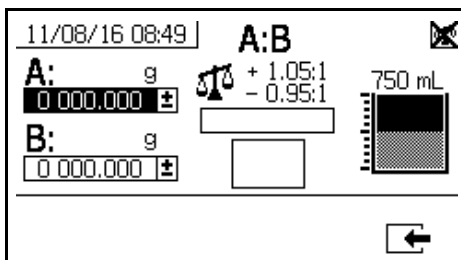

If the test passes, the "X" will disappear in the top right corner and Spray Mode can be used. The system is now calibrated for use.

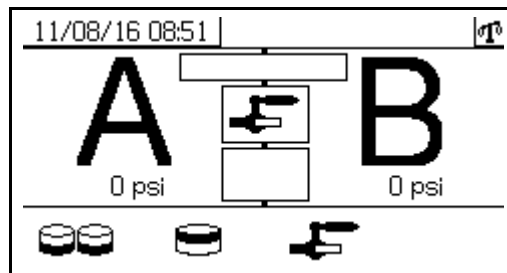

Down Stream Valve Leak Test

This test confirms or troubleshoots leaks in components located down stream of the dosing valves. Use this test to detect closed or worn valves, and to detect leaks in circulation valves installed at a remote mix manifold.



1. Close both mix manifold valves downstream of the dosing valves.
2. Close recirculation valves (AC, AD).
3. Enter Test mode in the run (fluid control) screen.
See **Test Screens** on page 77. Select  to run down stream valve leak test.
4. Select . Press . Ensure dosing valves (AA, AB) are open by verifying blue LEDs are illuminated for both dosing valves.
5. If test is successful, both metering pumps will stall against the downstream valves when the dosing valves (AA, AB) are open. If any movement is detected in the metering pumps after stalling, an alarm is issued indicating which side has a leak.

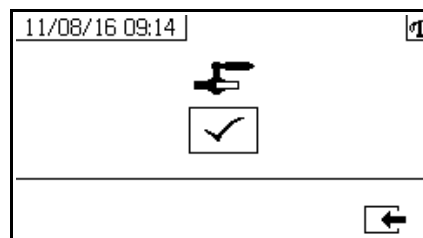

Mix and Integration Tests

Use the following tests to check for proper mix and integration.

Butterfly Test

At low pressure, normal flow rate, and without a spray tip installed, dispense a 1/2 in. (12.7 mm) bead of material onto foil until multiple changeovers of each metering pump have occurred. Fold the sheet of foil over the fluid then peel it back and look for unmixed material (appears marble-like).

Curing Test

Spray a single continuous pattern on foil at typical pressure setting, flow rate, and tip size until multiple changeovers of each metering pump have occurred. Trigger and de-trigger at typical intervals for the application. Do not overlap or cross over your spray pattern.







Check curing at various time intervals, listed on the material data sheet. For example, check for dry to touch by running your finger along the test pattern's entire length at the time listed on the data sheet.

Spots that take longer to cure indicate insufficient integration.

Appearance Test

Spray material onto metal substrate. Look for variations in color, gloss, or texture that may indicate improperly catalyzed material.

Empty and Flush Entire System

To avoid fire and explosion:

- Flush equipment only in a well-ventilated area
- Ensure main power is off and heater is cool before flushing
- Do not turn on heater until fluid lines are clear of solvent
- Always ground equipment and waste container
- Always flush at the lower possible pressure

Only perform this procedure when:

- The system will not be used for more than one month.
- Changing to a new material in the A or B side.

To flush a new system, see **Initial Startup** on page 29.

To flush only the mix manifold to the gun, see **Flush Mixed Material**, page 43.

NOTE: While hot water is sometimes used to flush mixed material from the system, it is not recommended for flushing the entire system. When flushing the entire system, use a solvent that dissolves the material.

This procedure is designed to minimize the volume of discarded A and B material when emptying and flushing the entire system.

1. **Flush Mixed Material**, page 43.

2. *If applicable*, remove the feed pump from pail:

- a. With director valve (DC) in the neutral position and the RAM air regulator (DB) backed out, slide main air slider valve (DA) ON.

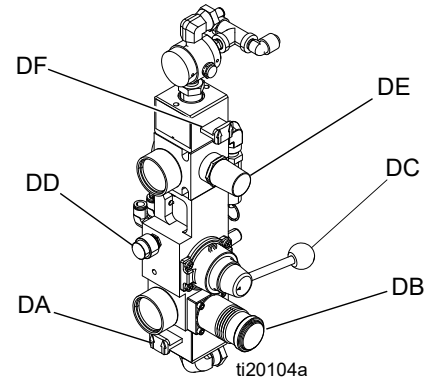
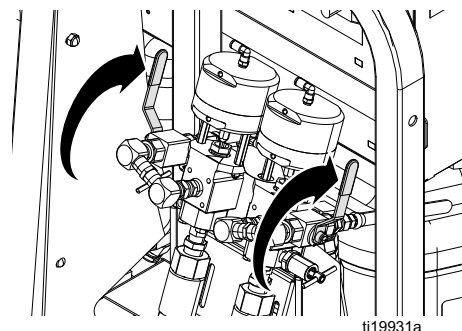

FIG. 39: Feed Pump Air Controls

- b. Lift the director valve to the UP position, then press and hold the blowoff button (DD) while increasing the air pressure using the RAM air regulator. When the feed pump exits the pail, move the director valve to the neutral position and release the blowoff button.
3. Empty the feed pump outlet material lines to the tank:
 - a. Slide the air motor slider valve (DF) ON.
 - b. Rotate air motor regulator (DE) to increase air pressure until feed pump begins to cycle. Continue until all material from outlet line to the tank have been pushed into the tank. This will be noticeable by an increase in feed pump cycle rate.
 4. Make sure all heaters are off and cool.
 5. Close the circulation valves.



6. Empty the A material tank:

- a. Close the A side mix manifold inlet ball valve.
- b. Disconnect the A material hose from the mix manifold at the fitting between the ball valve and check valve.

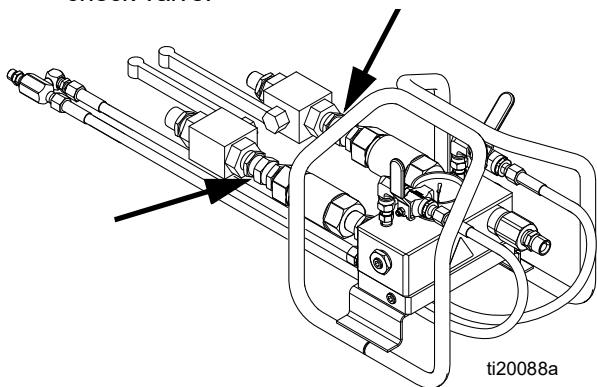

- c. Place the A material hose in a clean container to salvage the dispensed material. Make sure to have enough clean containers within reach to switch to as each container is filled.
- d. Open the A side mix manifold inlet ball valve.
- e. Press repeatedly to set to . Press . Slowly turn metering pump air regulator (CD) clockwise to increase air pressure until metering pump A starts. Continue pumping until the metering pump speed increases on its own which signals that the tank is now empty and there is air at the metering pump inlet. Press to stop metering pump then back out the air pressure regulator.
- f. Close the A side mix manifold inlet ball valve.
- g. Close the tank air supply ball valve then open the brass valve on the top of the tank to relieve tank air pressure.

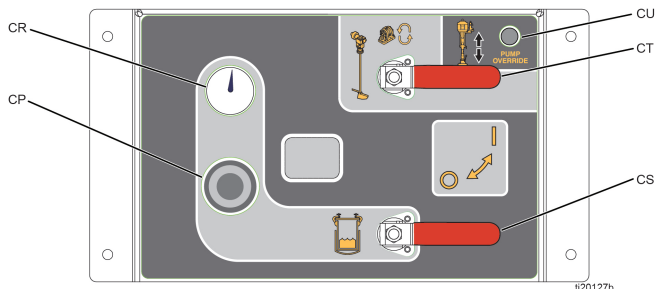

<p>The tank lid assembly is heavy. To prevent crushing your fingers if the tank lid is accidentally dropped, exercise caution while lifting the tank lid.</p>				

NOTICE
<p>The level sensor is very sensitive. Be careful not to damage it while lifting the tank lid.</p>

- h. Remove the tank lid assembly.
- i. Scrape remaining material from the walls of the tank into the tank outlet.
- j. Re-install the tank lid assembly.
- k. Close the brass valve on the top of the tank then open the tank air supply ball valves to pressurize the tank.
- l. With selected, press . Slowly turn metering pump air regulator (CD) clockwise to increase air pressure until metering pump A starts. Wait until the metering pump speed decreases, meaning that it is now primed with the new material from the tank inlet. Continue pumping until the metering pump speed increases, which means all of the material has been pumped and there is air at the metering pump inlet. Press to stop metering pump then back out the air pressure regulator.

7. Add solvent to the A material tank:

- a. On the A side feed module, close both feed system air control ball valves and back out the air pressure regulator. Open the brass valve on the top of the tank to fully relieve tank air pressure.

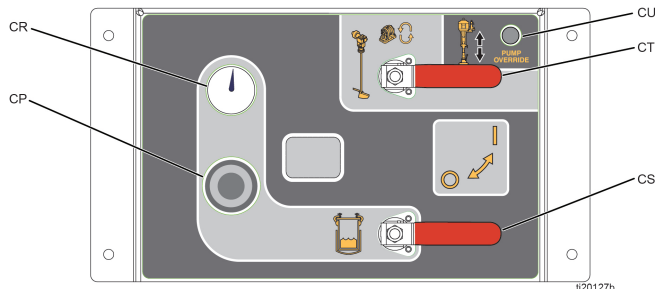

- b. Remove the platen from the A side feed pump by loosening the two setscrews and the air tube.
- c. Place a pail of solvent under the feed pump then slowly insert feed pump into the pail. The feed pump should rest on the bottom of the pail.
- d. Slide the air motor slider valve (DF) to ON. Adjust the air regulator (DE) so the feed pump runs very slowly.

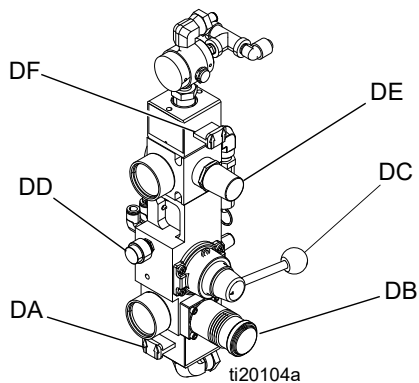





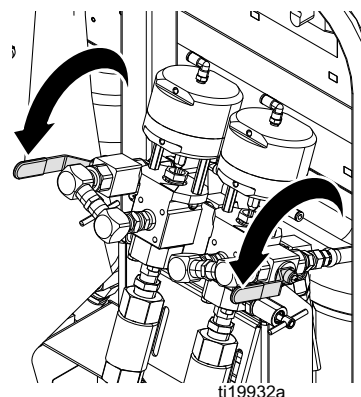



FIG. 42: Feed Pump Air Controls

- e. Continue adding solvent to tank until enough solvent is in the tank to expel the remaining material from the hose bundle material line.
8. Salvage the A material from the hose bundle material line then flush the hose bundle material line:
 - a. Press . Slowly turn metering pump air regulator (CD) clockwise to increase air pressure until metering pump A starts. Continue until the material appears to be thinner, which is a sign that the solvent is mixing with the material, then press  to stop the metering pump. Back out the air pressure regulator.
 - b. Cover the material container and store for later use.
 - c. Move the A material line to a waste container.
 - d. Press . Slowly turn metering pump air regulator (CD) clockwise to increase air pressure until metering pump A starts. Continue until clean solvent is dispensed, then press  to stop the metering pump. Back out the air pressure regulator.

- e. Reconnect hose bundle material line to the mix manifold.
- f. Disengage trigger lock then trigger gun into the waste container and press . Slowly turn metering pump air regulator (CD) clockwise to increase air pressure until metering pump A starts. Continue until clean solvent is dispensed, then press  to stop the metering pump. Back out the air pressure regulator.

9. Verify tank air pressure is still relieved, then purge the material from the tank return line.
 - a. Open the circulation valves.



- b. Disconnect the tank return line from side of the tank.
 - c. Place the return line in a waste container.
 - d. Press . Slowly turn metering pump air regulator (CD) clockwise to increase air pressure until metering pump A starts. Continue until clean solvent is dispensed, then press  to stop the metering pump. Back out the air pressure regulator.
10. Repeat this entire procedure for the B material side. Leave solvent in the lines to prevent scale buildup which could flake off.
 11. **Adjust Packing Nuts**, see page 59.

Prepare Level Sensor for Shipping

NOTICE

To prevent damage to the level sensor probe, do not ship the feed module with the tanks empty and the level sensor probe installed. This can cause the probes to vibrate severely and damage the level sensor head.

If possible, transport the tanks with at least 12 gallons (46 liters) of viscous material in the tanks, which is enough for the material level to be above the probe end and will prevent the probe from vibrating severely. If the tanks cannot be shipped with material, perform the following procedure.

1. Disconnect the 3/4 in. union below the level sensor head. The level sensor head will be loose but will not be removed. It is not necessary to remove the level sensor cable.

2. Use a pliers to grasp the flat on the rod and unscrew it out of the sensor head.
3. Pull the probe up out of the tank and tape it to the square tube frame securely to prevent vibration.
4. Replace the 3/4 in. union and level sensor head on the tank lid. Tighten securely for shipping.
5. After shipment, see **Install Level Sensor Probes** on page 22 to re-install.

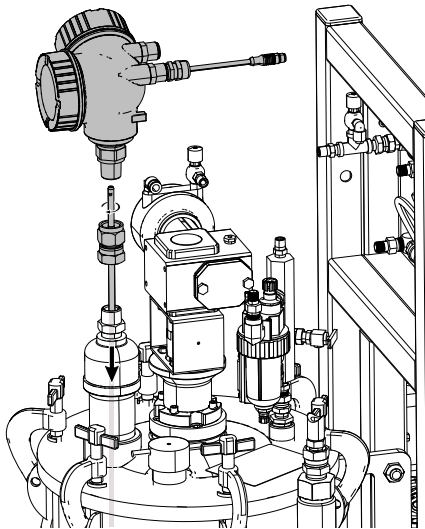

FIG. 43

Download Data from USB

USB Logs

By default, the ratio spray logs record data every 60 seconds. This 60 second interval will record about 32 days of data if spraying 8 hours per day, 7 days per week. To change the default, see **Download Setup**, page 57. This log can hold up to 18000 lines of data.

Ratio Log 1

(Default log for download.) The ratio log records date, time, machine number, job number, ratio target, ratio, batch volume, and ratio type (volume/weight) while the system is in Spray mode.

Spray Log 2

The spray log records key data while the system is in spray mode. It records A and B temperature, A and B pressure, A and B flow, A and B batch totals, ratios, restrictor adjustments, alarm codes, and commands.

Once the ratio or spray log is full, new data automatically overwrites old data.

After data in the ratio or spray log is downloaded it remains in the USB module until it is overwritten.

Event Log 3







The event log records all event codes generated over a two year period. This log should be used for troubleshooting purposes and cannot be deleted. This log can hold up to 39000 lines of data.

Data Log 4

The data log records (every 120 seconds) all data that occurs during spray mode over a two year period. This log should be used for troubleshooting purposes and cannot be deleted. This log can hold up to 43000 lines of data.

The 120 second recording period cannot be adjusted.

Download Setup

Navigate to the System Setup screen. Change the number of hours of recorded data to download (default is 768 hours), by pressing  and  to move to . Press  to make the field selectable. Press  to scroll through each digit. Press  to save the new digit. Follow the same procedure to change the time interval at which data will record in the future (default is 60 seconds). Exit the System Setup screen.

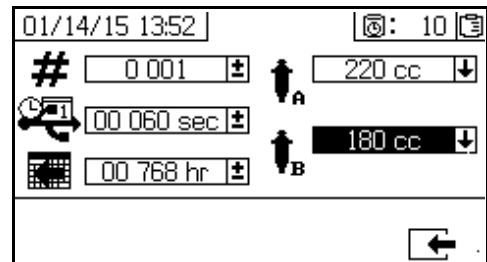

Download Procedure

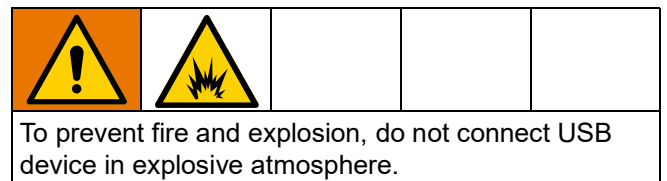

1. Insert USB flash drive into USB port (DR). Use only Graco-recommended USB flash drives; see **Recommended USB Flash Drives**, page 83.

NOTE: Inserting the USB flash drive while the sprayer is running will stop sprayer operation.

2. The USB download screen automatically displays, and the selected log(s) automatically downloads. The USB symbol flashes to indicate download is in process.

NOTE: To cancel download, press  while in process. Wait for USB icon to stop flashing, and then remove USB flash drive.

Download Data from USB

3. The USB icon stops flashing when download completes. The box below displays  , which indicates the download was successful
4. Remove USB flash drive from USB port (DR).
5. Insert USB flash drive into USB port of computer.
6. The USB flash drive window automatically opens. If it does not, open USB flash drive from within Windows[®] Explorer.
7. Open Graco folder.
8. Open sprayer folder. If downloading data from more than one sprayer, there will be more than one sprayer folder. Each sprayer folder is labeled with the corresponding USB serial number.
9. Open DOWNLOAD folder.
10. Open folder labeled with the highest number. The highest number indicates the most recent data download.
11. Open log file. Log files open in Microsoft[®] Excel[®] by default. However, they can also be opened in any text editor or Microsoft[®] Word.

NOTE: All USB logs are saved in Unicode (UTF-16) format. If opening the log file in Microsoft Word, select Unicode encoding.

Maintenance

See the following table for maintenance tasks and frequency. See the following sections for details for each task.

Frequency	Task
<ul style="list-style-type: none"> • Before first use • After first hour of operation • After first day of operation • Whenever TSL is discolored or has seeped over the packing nut, and after sprayer has been transported 	Adjust packing nuts
Weekly	Filters
	Seals
As Needed	Add oil to agitator motor lubricators. Use Graco Air Motor Oil 202659 (provided with supply unit) or low/low-30 detergent oil.
	Clean the system
Yearly or When Changing Materials	Disassemble and clean the A and B material heaters.

Adjust Packing Nuts



NOTE: There must be no pressure when adjusting the packing nuts.

1. Follow **Pressure Relief Procedure**, page 45, including relieving air pressure in the tanks.
2. Fill A and B metering pump packing nuts with throat seal liquid (TSL™).
3. After TSL is added, torque metering pump packing nuts to 50 ft-lb (67.5 N•m). Follow instructions in Xtreme Lowers manual 311762.

4. Fill A and B dosing valves packing nuts with throat seal liquid (TSL).
5. After TSL is added, tighten dosing valve packing nuts 1/4 turn after nut contacts packings; about 145-155 in-lb (16-18 N•m).

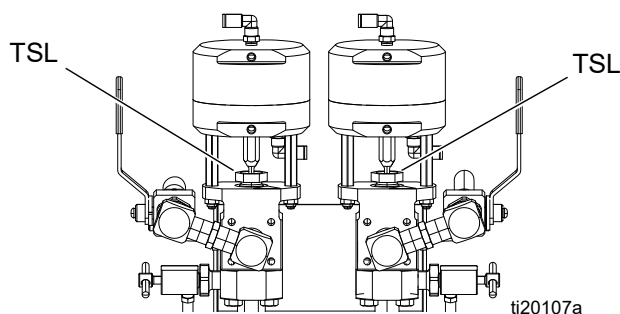

Filters

Once a week check, clean, and replace (if needed) the following filters.

- Main air inlet manifold filter; see XM PFP Repair - Parts manual 3A2989, Replace Air Filter Element section, for instructions.
- Air regulator filter (5 micron) on air control assembly; see XM PFP Repair - Parts manual 3A2989, Replace Air Filter Element section, for instructions.

Seals

Once a week, check and tighten throat seals on metering pumps and dosing valves. Be sure to follow the **Flush Mixed Material**, page 43, prior to tightening seals.

Battery

The front display battery must be changed in a nonhazardous location only. See XM PFP repair manual for instructions.

Use only Panasonic® CR2032 batteries for replacement.

Clean the System

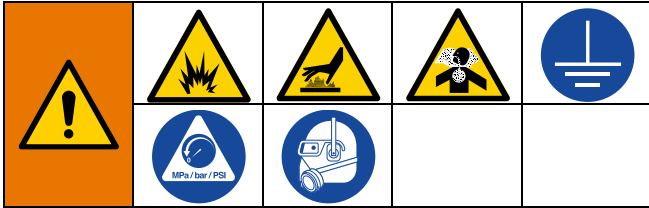

1. Ensure all equipment is grounded. See **Grounding**, page 19.
2. Ensure the area where the sprayer will be cleaned is well ventilated and remove all ignition sources.
3. Turn off all heaters and allow equipment to cool.
4. Flush mixed material. See **Flush Mixed Material**, page 43.
5. Perform **Pressure Relief Procedure**, page 45. This includes flushing the system and parking the metering pumps.

6. Turn main power switch OFF.

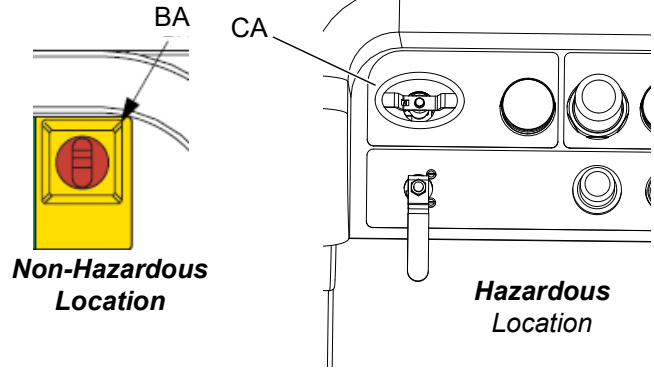

7. Clean external surfaces only using a rag soaked in solvent that is compatible with the spray material and the surfaces being cleaned.
8. Allow enough time for solvent to dry before using sprayer.

Troubleshooting Information

Alarms

See **Appendix B - Alarms**, starting on page 84.

General Tips

The following information will help ensure the system is set up properly.

Grounding

- Ensure incoming power is grounded.

Air Supply

- Use at least a 3/4 in. (19mm) ID air hose, no longer than 50 feet (15m).
- Ensure the first air pressure supply gauge stays above 80 psi (0.55 MPa, 5.5bar) while spraying.
- Ensure that the metering pump air pressure regulator is set to at least 35 psi (2.4 bar) for spraying.
- Ensure that the solenoid air filter/regulator behind the air panel is set to at least 80-85 psi.
- Check that the air filter element in the solenoid air filter/regulator behind the air panel is clean.
- Check that the main inlet air filter is clean.

Calibration

- Ensure dosing valve needle packing nuts are not adjusted too tight. They should be snug when there is no fluid pressure on the valve.

Motor Icing

Air motors accumulate ice in the exhaust valving and muffler under hot and humid conditions or under cold ambient conditions. It can cause pressure loss or motor stalling.

- The 'B' fluid pressure should always be 15% to 30% higher than 'A' pressure.
- A larger pressure difference indicates 'A' motor icing.
- A smaller or negative pressure difference indicates 'B' motor icing.
- If icing occurs, use the de-ice bleed air valve to run warm air through the valve to run warm air through the valve and exhaust for de-icing.
- Ensure that the motor is left active when not spraying to keep the internal bleed air working. Leave the motor active in Spray mode or Manual mode to keep the bleed air on.

Restrictions or Lost Pressure

- Check that the static mixer and whip hose are clean.
- Check the check valves for build up if spraying fiber-filled material.
- Clean the A and B heater cores.

Mix Manifold

- Ensure that the 'A' and 'B' outlet hose sizes are volume balanced close to the mix ratio. Unbalanced hose sizes can cause off-ratio slugs at the mix manifold during pressure and/or flow transitions. See XM PFP Mix Manifold manual.
- If less integration and mix hose is used than what is recommended, ensure that "Fast Dosing" is selected in the setup screens.

Software Version

- Ensure all modules in the system use software from same token. Different software versions may not be compatible.
- The latest software version for each system can be checked at Tech Support at www.graco.com.

Individual Control Module LED Diagnostic Information

The following LED signals, diagnosis, and solutions are the same for the display module, advanced fluid control module (AFCM), fluid control cube, high power temperature control module (HPTCM), and USB module. LEDs are located next to the module power cable.

Module Status LED Signal	Diagnosis	Solution
Green on	System is powered up and power supply voltage is greater than 11 Vdc.	---
Blue (HPTCM only)	Voltage is being sent to the heater	---
Yellow	Internal communication in progress	---
Red solid	Hardware failure	Replace module.
Red flashing fast	Uploading software	---
Red flashing slow	Token error	Remove token and upload software token again.

Troubleshooting



All electrical wiring must be done by a qualified electrician and comply with all local codes and regulations.

NOTE: Pressure Relief Procedure on page 45 before servicing the system.

NOTE: The sprayer operates using air pressure. Many problems are caused by inadequate air supply. The inlet air pressure gauge cannot drop below 80 psi (0.5 MPa, 5.5 bar) while running.

Problem	Cause	Solution
Display not lit. No green light present on back of display module.	No electric power. Disconnect "off" or breaker "open."	Reset main disconnect and breaker.
	Voltage jumpers not installed or configured in power junction box.	Install red jumpers in junction box terminal blocks. See Connect Power Cord on page 19.
	No green lights present on display, FCM, or USB module.	Check for 24 Vdc on J1, pins 2 and 3, of power supply. See Electrical Schematics in the XM PFP repair manual. If there is not 24 Vdc, replace power supply module. See XM PFP repair manual.
	No display power through CAN cable. Green light in present on AFCM, but is not present on USB module.	Check CAN cable. Replace if necessary. See the XM PFP repair manual.
	Green light is present on USB module.	Check CAN cable. Replace if necessary. See the XM PFP repair manual.
Display not lit on system. Green light is present on back of display module.	Display module failed.	Replace display module. See the XM PFP repair manual.

Problem	Cause	Solution
Metering pumps do not run when Run Mode is selected and the blue LED is illuminated.	Air pressure to metering pumps too low	Increase pressure to 50 psi (0.35 MPa, 3.5 bar) or greater.
	Air pressure to metering valves is too low.	Check air regulator behind main air panel. Should be 80-85 psi (0.55-0.59 MPa, 5.5-5.9 bar).
	Circulation valves or mix manifold ball valves are not open.	Open ball valves.
	Air pilot lines are obstructed	Check pilot lines for kinks or pinches.
	Solenoid valve stuck.	Actuate solenoid manually, if it does not operate, replace solenoid. See the XM PFP repair manual.
	Air pilot valve(s) to motor stuck.	Replace valve(s). See XM PFP repair manual.
	Metering valve(s) not opening.	Service or replace valve(s). See XM PFP repair manual.
	Air motor stalled.	See manual 3A5423.
Pump Test completes without error, but A or B component has more than 750cc of fluid in beaker.	Incorrect metering pumps were selected in System Setup screens.	See Appendix A - User Interface Display beginning on page 66.
	Air is trapped in fluid due to excessive agitation, circulation, and heat. Fluid is measured by volume when it is compressed under pressure.	Repeat Pump Test with fresh fluid. If the specific gravity of each fluid is known, check samples by weight (750cc x specific gravity equals weight in grams). If weight is correct, extra volume in beaker is air.
Batch Test completes without error, but A or B component has more fluid in beaker than displayed on screen.	See causes for previous pump test problem.	See solutions for previous pump test problem.
Sprayer does not start when start button is pressed.	Faulty start switch or wire harness.	Check start switch and wiring harness continuity; switch is normally open circuit. See Electrical Schematics in the XM PFP repair manual.
	Faulty stop switch or wiring harness.	Check stop switch and wiring harness continuity; stop switch is normally closed circuit. See Electrical Schematics in the XM PFP repair manual.
Fluid valves leaking at rod.	Loose or worn packings.	Tighten packing nut. If leak continues, replace packings.
Fluid valve leaking between main and outlet housings.	O-ring on seat has failed.	Replace both o-rings on that seat.
Material does not cure consistently.	Ratio not set correctly.	Check that correct ratio is set and set by volume.
	Material not mixing correctly.	Test metering pump. Make sure mixer is clean; flush as needed.
		Position mixer after integrator hose.
	Material not properly conditioned before it was added to sprayer.	Mix material thoroughly.
Not using enough integration hose.	Add more integration hose.	
	Select "fast dosing" in setup.	

Problem	Cause	Solution
Poor spray pattern. Also, see "System runs erratically" below.	Fluid pressure too low.	Increase metering pump pressure.
	Fluid temperature too low.	Increase fluid temperature.
	Spray tip dirty or worn.	Relieve pressure. Clean or replace tip. Follow gun manual instructions.
	Mix manifold, mixer, swivel, gun, or hoses partially plugged or too restrictive.	Inspect parts for cured material. Clean or replace, or use larger hoses and mixer.
System runs erratically.	Air filter(s) clogged.	Clean. Replace element(s).
	Air supply hoses undersized.	Replace hoses with appropriate size.
	Air compressor undersized.	Use larger air compressor.
	Air supply pressure tank undersized.	Use larger pressure tank.
	Inlet air pressure gauge drops below 50 psi (0.35 MPa, 3.5 bar) while spraying.	See solutions above for system runs erratically problem.
	A and/or B air motor has ice.	Open air motor de-ice bleed air control. Allow ice to melt. Dry the compressed air. Heat the compressed air. Use a smaller tip and lower flow rate.
	Metering pump is binding.	Repair lower. See XM PFP repair manual.
Air supply relief valve opens.	Air regulator set too high.	Lower setting.
Flow rate too low.	Air supply hose is too small or too long.	Use 3/4 in. minimum ID air supply hose. See Technical Specifications , page 98.
	Inadequate air supply.	Use larger CFM compressor.
	Air pressure to metering pumps too low.	Increase metering pump air pressure.
	Spray tip too small.	Relieve pressure. Install larger tip. Follow gun manual instructions.
	Mix manifold, mixer, swivel, gun, or hoses partially plugged or too restrictive.	Inspect parts for cured material. Clean or replace, or use larger hoses and mixer.
Receive ratio alarm after starting in spray mode while using remote mix manifold.	A and B hoses do not fill to correct pressure ratio simultaneously. Therefore, spray time increases in order to balance pressure. Ratio screen bar graph stays to one side until pressure balances.	Pressurize outlet hoses in manual A/B pump mode. Then start spray mode.
		Select correct hose size to balance your volume ratio. See XM PFP Mix Manifold manual.
Receive ratio alarm while using remote mix manifold after a significant change in pressure.	A and B hoses do not fill to correct pressure ratio simultaneously. Therefore, spray time increases in order to balance pressure. Ratio screen bar graph stays to one side until pressure balances.	Pressurize outlet hoses in manual A/B pump mode. Then start spray mode.
		Select correct hose size to balance your volume ratio. See XM PFP Mix Manifold manual.
		Change pressure slowly while spraying.

Problem	Cause	Solution
Purge Controller right indicator does not turn green. (Hazardous Location Models)	Leak in purge box or inadequate air supply.	<p>Check purge box for leaks.</p> <p>Make sure all cable glands are tight, sensor and CAN cable glands include a rubber grommet. Verify mounting screws in purge controller are tight. Verify 8 mounting screw for explosion-proof box are tight. Verify door latches are tight and door mounting screws are tight.</p> <p>Verify air regulator to purge controller-mounted in front sprayer air panel) is set to 80 psi. Verify no air blockage to purge controller. Verify flow control valve in purge controller is open. Verify bottom port closest to purge controller output is open. See Expo manual for additional troubleshooting.</p>
Purge Controller left indicator does not turn green. (Hazardous Location Models)	Leak in purge box or obstructed purge exhaust.	<p>Check purge box for leaks. See above for possible leak locations.</p> <p>Verify pinch valves in purge controller are all closed except for the 2 min pinch valve. Verify no obstruction on purge enclosure exhaust.</p>
Both purge controller indicators are green but display screen does not turn on.	Obstructed air line or loose wiring.	<p>Verify air line between purge controller (through flame arrestor) and pressure switch in explosion proof box is not obstructed.</p> <p>Verify wiring is secure in explosion proof box between the pressure switch terminals and the contactor. Verify wiring from explosion proof box to purge box (large explosion proof bushing).</p>

Appendix A - User Interface Display

The user interface display is divided into three main functions: Setup, Command, and Automatic.

Setup Mode Screens (key to right)

Use these screens to:

- change between volume and weight ratio
- set desired mix ratio by volume or weight
- set weight ratio and tolerance for ratio checks
- configure system settings
- set potlife parameters
- enable/disable functions, displays, and display components
- set which USB logs to download
- schedule maintenance parameters for alarms and advisories
- set pressure and temperature limits
- set tank “fill” and “full” levels

Some setup functions must be enabled from the Enable Setup screens before users can change or set configurations. See **Enable Setup Screens**, page 71, for instructions.

Operator Command Mode Screens (key to left or removed)

Use these screens to:

- run pumps, including flush, circulate, and prime procedures
- park metering pumps so pump rods are down when not in use
- mix and spray
- view mix ratio
- run pump tests/calibrate weight mode
- run batch dispense ratio tests
- run valve leak checks
- view dispense totals
- view alarms
- diagnose alarms
- clear alarms
- set and view A heater, B heater, and hose bundle temperatures
- view tank temperatures and levels

Automatically Displayed Screens

These screens are shown when

- The potlife timer alarms to notify the user that material is about to cure in the system.
- download USB logs.

Change a Setting

All settings are changed in the same manner:

1. Navigate to the desired screen. See **Operator Command Mode Screens** on page 74, or **Setup Mode Screens** on page 67.
2. Once in the desired screen, use the arrow keys to navigate to the item that you wish to change.
3. Press enter to enter editing mode.
4. Use the arrow keys to change the selection or value.
5. Press enter again to save the change or press  to cancel the change.

Alarms

See **Appendix B - Alarms**, starting on page 84.

Setup Mode Screens

To enter the Setup Mode screens, turn the setup key lock (DJ) to the right. The key cannot be removed when in Setup Mode. See FIG. 7 on page 15. Some setup screens can be disabled, see **Enable Setup Screens** on page 71.

Setup Mode Screens Navigation Diagram

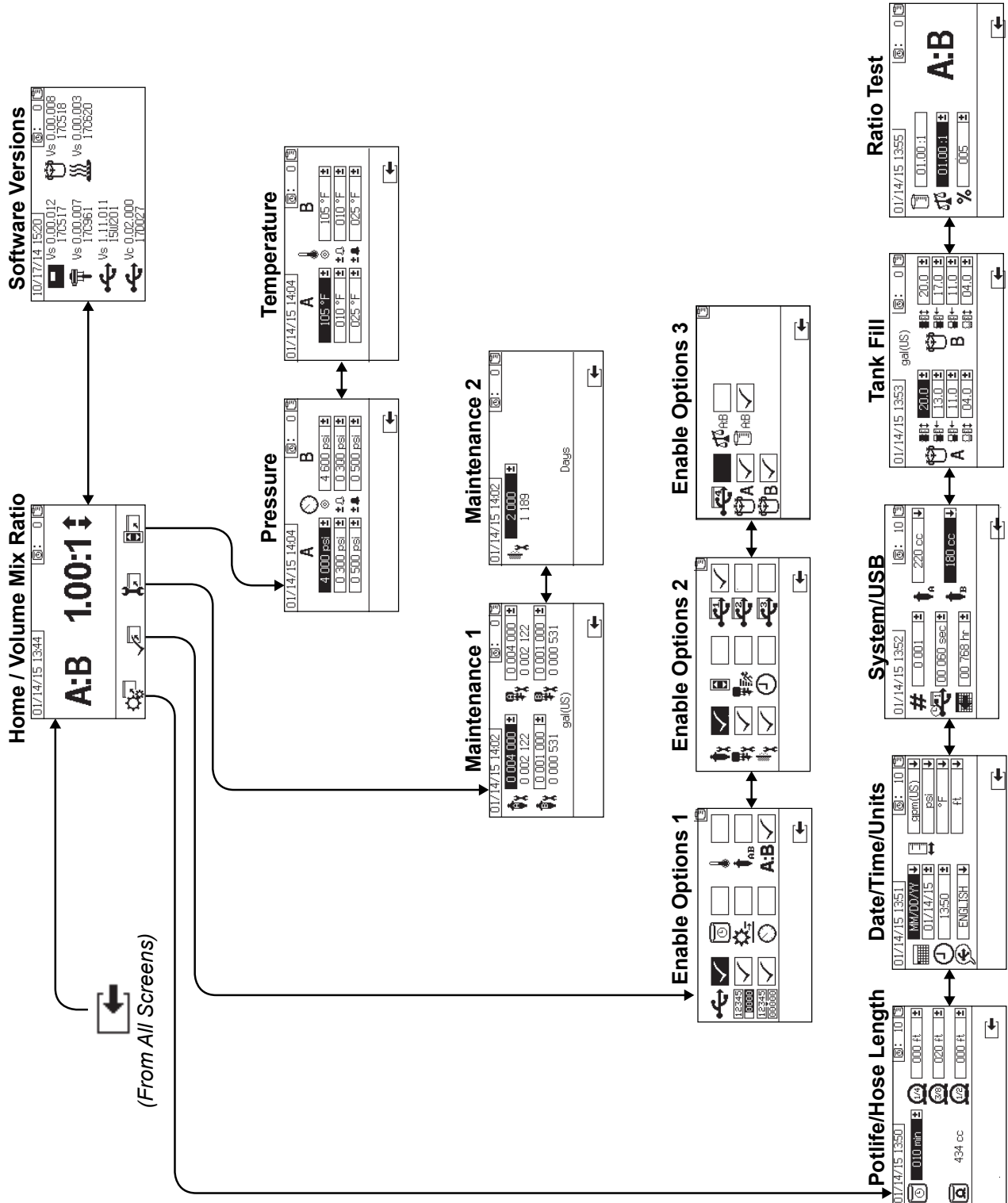

Home Setup Screens (Key Switch On)

Home

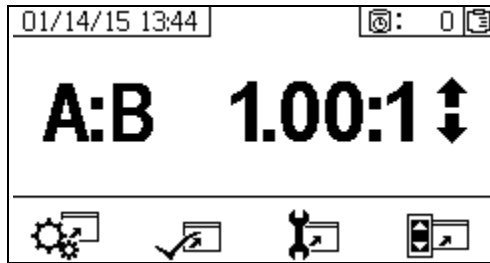

Home is the first screen that displays in Setup mode. It shows the current metering pump ratio and enables users to change the mix ratio and access the following screens: system setup, enable/disable functions, maintenance setup, and limits. Refer to the following table for more details.

Icon	Function
	Increase or decrease mix ratio. Press and to change the mix ratio.
	Navigate to jump to system setup screens.
	Navigate to enable/disable options screens.
	Navigate to maintenance setup screens.
	Navigate to pressure and temperature limits setup screens.

.Software Versions

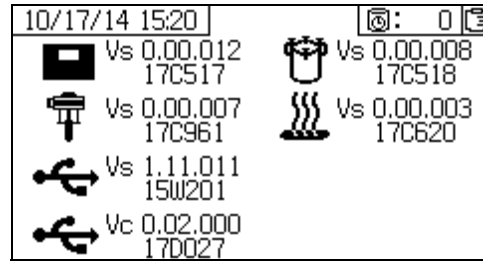

This screen displays the versions and part number of the system components. Refer to the following table for details. To access this screen, press from the Home Setup screen.

Icon	Function
	Display module version (Vs) and part number
	Advanced fluid control module version (Vs) and part number
	USB version (Vs) and part number USB Configuration (Vc) and part number
	Fluid control cube version and part number
	Temperature control module version and part number (Vs)

System Setup Screens

System Setup enables users to configure system settings for fluid control and operator interaction. Refer to the following table for details.

Some system settings must be enabled from the Enable Setup screens before users can change or set configurations. See **Enable Setup Screens**, page 71, for instructions.

Icon	Function
	Set number of minutes before mixed material will set in hose. Resets after material volume set by user is passed through hose.
	Indicates total hose volume. Always displayed in cc units.
	Set length of hose after mix manifold. Used to indicated total hose volume.
	Set calendar date and format.
	Set time.
	Set USB language.
	Set units of measurement desired for display, such as fluid and temperature.
	Set sprayer number if using more than one sprayer.
	Set how often data will record to USB ratio and spray logs.
	Set number of hours of recorded data to download to USB flash drive.
	Set the A and B side metering pump sizes.
	Volume ratio reference
	Weight ratio reference
	Ratio Pass Tolerance

Potlife/Hose Length

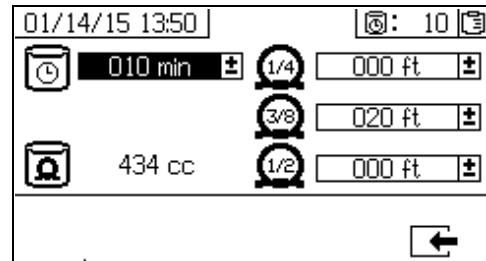

This screen enables users to set the potlife timer, and length of each mixed material hose specific to the system. The total mixed material volume is then calculated and displayed on the page. The potlife time displays in the upper right corner.

When the fluid flow stops the displayed potlife time counts down in one minute intervals. The timer automatically resets when the calculated mixed fluid volume is dispensed.

Date/Time/Units

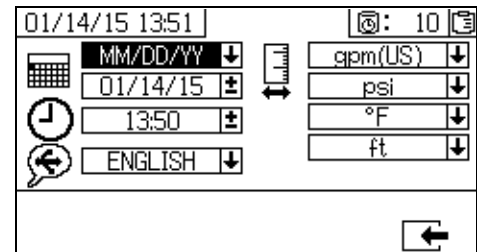

Use this screen to set day, time, and units that will be displayed on each screen. The selected language is used in each USB log. The following USB languages are supported: English, French, German, Spanish, Russian, Italian, Chinese, Japanese, Korean, Norwegian, and Polish.

System Number and USB Settings

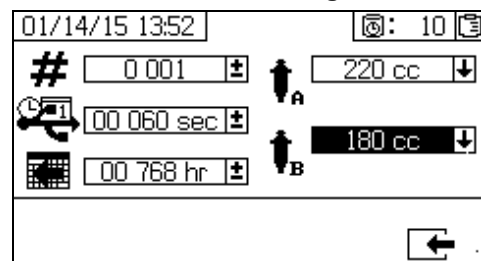

Use this screen to set the sprayer number if using more than one sprayer, and to configure the number of hours downloaded to external USB flash drive and how often the data will record.

Pump Configuration

Users can change the pump size that is specific to the system if the pump box is selected on **Enable Setup Screen 1**, page 72.

NOTICE

Changing the pump size settings may cause the system to spray off ratio.

Set Pump Sizes

To change the pump size, press and to select the field. Press to open the drop down field.

Press and to select the preferred pump size.

Press again to save the change.

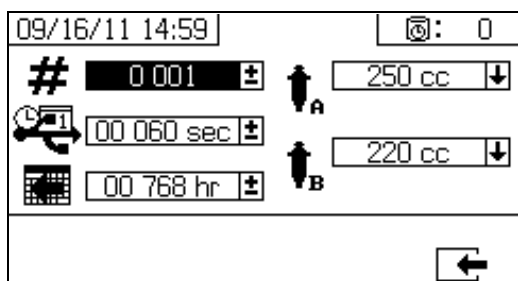

Set Custom Pump Sizes

Custom pump sizes can also be entered. In the pump size box describes above, select CUSTOM as the pump size. A new pump volume entry field will appear as

shown below. Press and to select the volume entry field. Press to begin editing.

Enter the pump size in cubic centimeters (cc). To enter a number press and to change numbers. Press and to move between digits.

Press to exit the field.

The entered pump volume will be saved by the system, but it will only be used when CUSTOM is selected. Pump A and pump B volume are entered separately.

The standard pump sizes of 290 cc, 250 cc, and 220 cc have maximum pressure limits of 5600 psi (38.6 MPa, 386 bar), 5600 psi (38.6 MPa, 386 bar), and 6000 psi (41.4 MPa, 414 bar), respectively. Other pump sizes

and the custom pump size (for any volume entered) have a maximum pressure limit of 7000 psi (48.3 MPa, 483 bar).

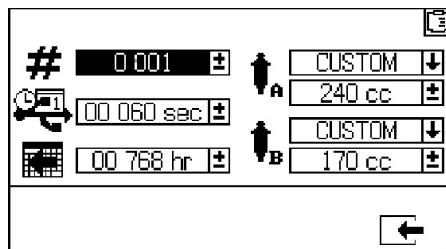

Tank Fill

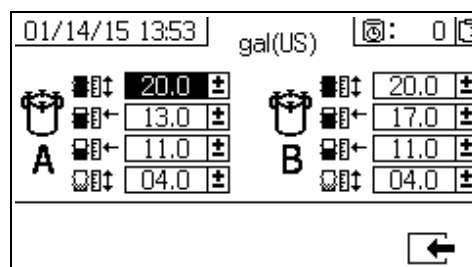

Graco recommends leaving all of the settings on this screen at the factory defaults.

This screen can be used to adjust tank level settings. The default settings from the top of the screen to the bottom are 20, 14, 11.5, and 11.2, when gallons is the selected unit of measure on the system. The level sensors cannot detect fluid under the 11 gallon level.

The top and bottom settings are used for maximum and minimum settings for the tanks on this machine and should not be changed. If the tank level goes beyond one of these settings, an alarm will result. See **Alarm Code Troubleshooting** on page 88.

The middle two settings are for maintaining the tank level when automatic tank filling is on. Automatic tank filling will maintain the fluid level in the tank to between these two levels. Changing these levels will move the arrows shown next to the tanks on the Supply screen. When using fiber-filled or compressible fluids, do not set the high arrow too high. When the tank is depressurized with too much fluid in the tanks, the fluid can expand and rise up into the tank lid air passages.

Each value must be larger than the value below it. The second settings (tank fill level) cannot be set above 85% of the tank size.

Ratio Test

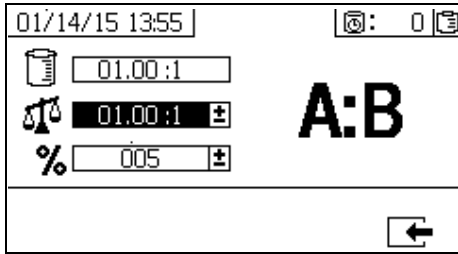

For **Ratio by Volume Mode**, use this screen to set the ratio by weight (middle number), and the ratio tolerance (bottom number). The values determine whether the ratio test passes. The ratio by volume (top number) is displayed but cannot be changed on this screen. See **Home** screen on page 68 to change the ratio by volume.

For **Ratio by Weight Mode**, use this screen to set the ratio by weight tolerance (bottom number). The ratio by weight (top number) is displayed but cannot be changed on this screen. See **Home** screen, on page 68, to change the ratio by weight.



Enable Setup Screens

Use these screens to enable and disable functions, screens, and USB download log files. Checked boxes indicate the function, screen, or log file is enabled. Refer to the following table for details.

To enable and disable functions, screens, and USB log files, press from the Home Setup screen. Once in the Enable Setup screen, press and to scroll through each subscreen. Press and to scroll through each field within the subscreens, and press to enable or disable each. Press to return to the Home Setup screen.

Icon	Function
	USB data download function. Disable this function to prevent operators from changing USB settings. Even if this function is disabled, selected USB logs will still be downloaded.
	Enable or disable totalizer screens.
	Enable or disable batch totalizer clear function.
	Display potlife timer on all screens. Enable or disable potlife timer setup screen.
	Display flow rates on run screens
	Display A and B pressures on run screens.
	Display A and B heater outlet temperatures on run screens.
	Enable or disable ability to change metering pump size in system setup screens.
	Enable or disable ratio screen. If enabled, ratio screen will automatically display after sprayer runs for 10 seconds.
	Enable or disable pump maintenance setup screens.
	Enable or disable dosing valve maintenance setup screen.
	Enable or disable incoming air filter maintenance setup screen.

Icon	Function
	Enable or disable limits (pressure and temperature) screens.
	Fast dosing function. Enable function to minimize B side dose size and increase dosing rate. See table below. Use this function with short integration hose. The system will attempt to hold the dosing sizes below the advisory level.
	Display time on all screens.
	Enable or disable downloading individual USB log files (1-4).
	Enable or disable the A or B feed system. When disabled, that feed system will not be shown on the user interface and no alarms will be generated for that feed system. This enables the user to use the air shutoff valve on the feed pump to turn on and off the feed pumps if there is a problem with the feed system.
	Selects system ratio by volume or ratio by weight mode. Only one of these modes can be enabled at one time.

Fast Dosing Function

Fast Dosing	Advisory QTAE	Alarm QDAE
ON	20 cc	30 cc
OFF	35 cc	45 cc

Enable Setup Screen 1

(Shown with factory default settings.)

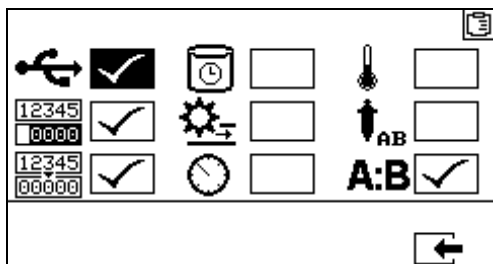

Enable Setup Screen 2

(Shown with factory default settings.)

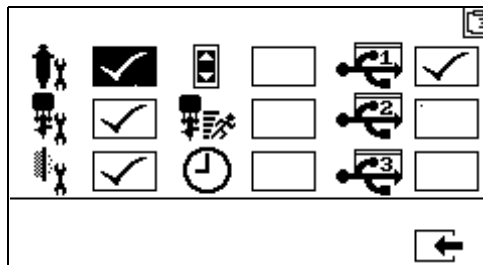

Enable Setup Screen 3

(Shown with factory default settings.)

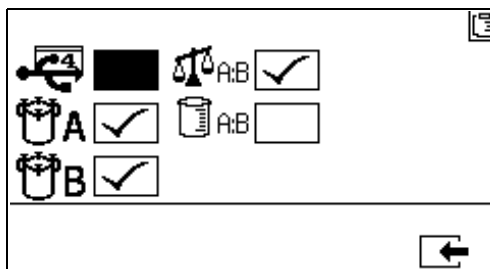

The machine will be shipped in Weight Mode.

Maintenance Setup Screens

Use these screens to set maintenance setpoint amounts for pumps and dosing valves. The maintenance setup 2 screen enables users to schedule the number of days between changing the main incoming air filter before a reminder advisory will sound.

The number displayed below each selectable field indicates the amount of material dispensed, counting up to the setpoint requiring maintenance.

Icon	Function
	Set amount of material moved through pump that will result in a maintenance warning.
	Set amount of material moved through dosing valve that will result in a maintenance warning.
	Set number of days between changing the main incoming air filter before a reminder advisory is issued.

Maintenance Setup 1

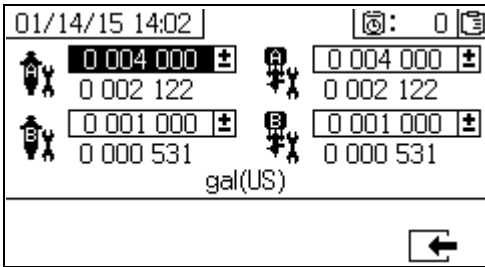

Process Pressure Limits (for spray mode)

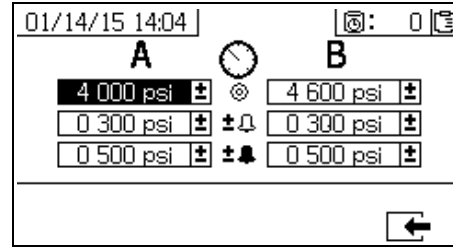

Maintenance Setup 2

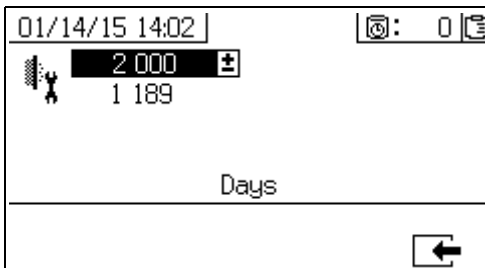

Process Temperature Limits (for spray mode)

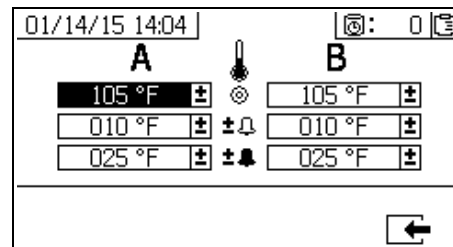

User Limits Setup Screens

Use these screens to set and adjust pressure and temperature limits for both metering pumps, including limits that will issue advisories and alarms. Refer to the following table for details.

The allowable range for the temperature setpoint is 34° - 160°F (1° - 71°C). If the temperature or pressure setpoint is zero, pressure limits and alarms are disabled.

NOTE: The B metering pump pressure always runs 10-20% higher than the A metering pump pressure.

Icon	Function
	Set and adjust pressure limits for both metering pumps during spray mode.
	Set and adjust high and low temperature limits for both fluid heaters during spray mode.
	Set target pressure or temperature.
	Set and adjust limits above or below target value that if exceeded will issue an advisory. Used with pressure and temperature limits.
	Set and adjust limits above and below target value that if exceeded will issue a alarm. Used with pressure and temperature limits.

Operator Command Mode Screens

To enter the Operator Command Functions screens, turn the setup key lock (DJ) to the left. See FIG. 7 on page 15.

Operator Command Mode Screens Navigation Diagram

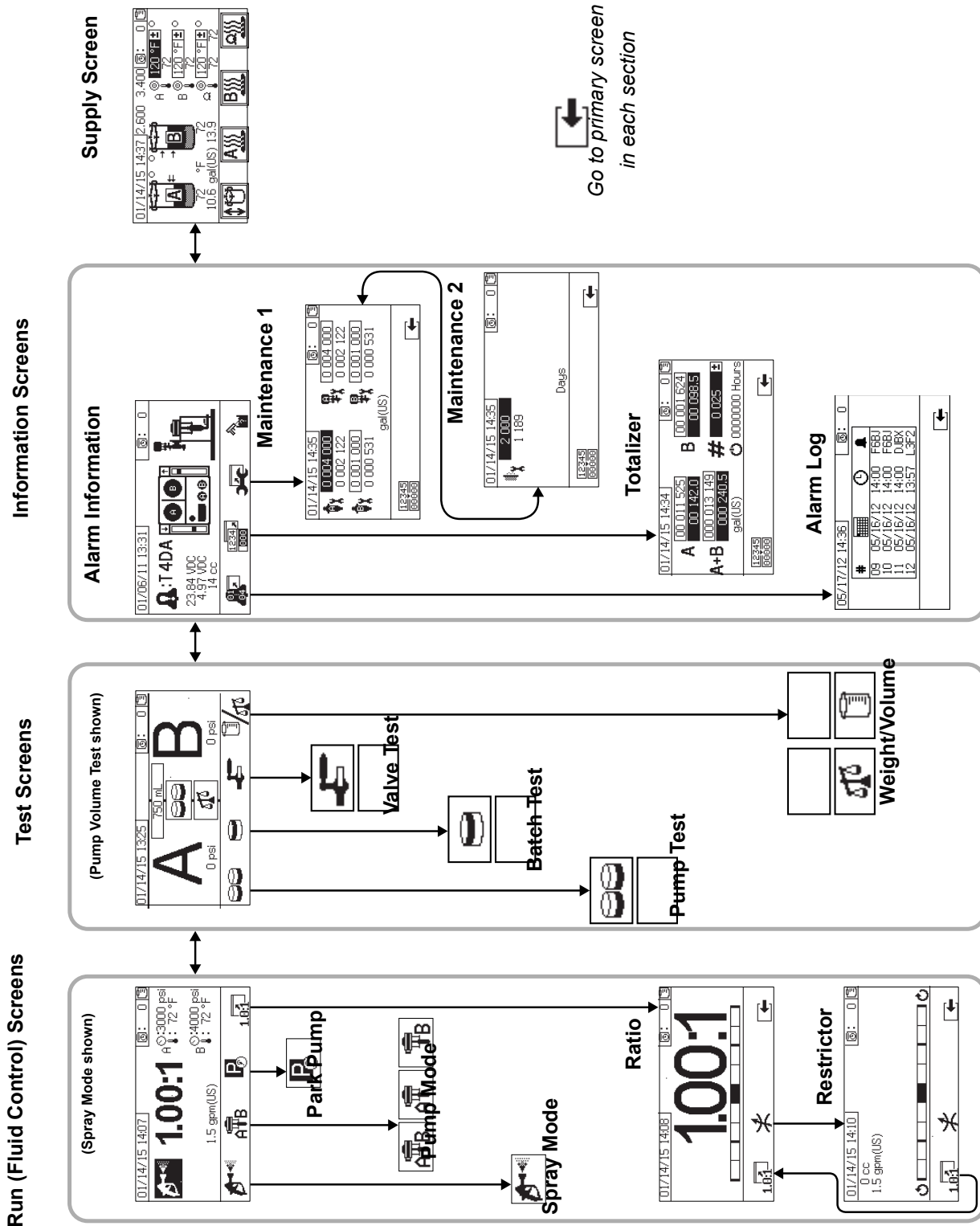







Run (Fluid Control) Screens

Run (fluid control) is the first screen displayed at power on. It enables users to spray material, and operate and park metering pumps. Run consists of two screens: power on/enter and ratio mode.

The power on/enter screen cycles through power on mode, spray mode, pump mode, and park mode. It displays the current ratio setpoint when in spray mode and may also display: pressure, temperature and flow rate if these options are enabled.

The ratio screen displays the current ratio and monitors the B side restriction adjustment.

Icon	Function
	<i>Spray</i> : proportion and spray material.
	<i>Icon at bottom of screen</i> : Select which metering pumps are active. Press repeatedly to cycle through metering pump A, metering pump B, and both metering pumps. <i>Icon in rectangle</i> : Operate both metering pumps.
	Operate the A metering pump only (priming, flushing).
	Operate the B metering pump only (priming, flushing).
	<i>Park Metering Pumps</i> : run metering pumps to bottom of the stroke.
	<i>Ratio</i> : jump to ratio screen.

Power On/Enter Mode

Power On/Enter Mode is the default screen when users enter Fluid Control.

This screen remains blank until a mode is selected.

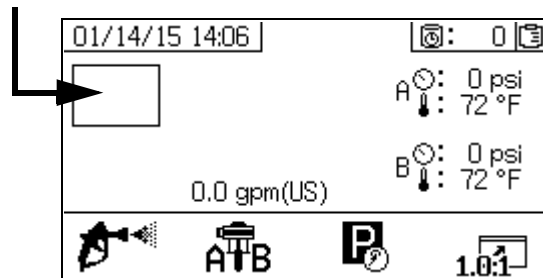

Spray Mode

Users must be in this mode to spray or proportion material. Press the button below the spray icon to enter this mode.

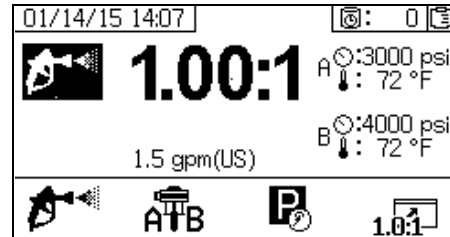

Pump Mode

Users must be in this mode to operate metering pumps for priming or flushing. Press the button below the metering pump icon to enter this mode. Continue pressing the metering pump icon button to cycle through metering pump A, metering pump B, and both metering pumps.

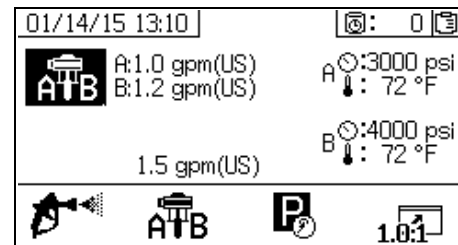

Park Mode

Users must be in this mode to park the metering pump fluid rods to the bottom of their stroke. Press the button below the park icon to enter this mode.

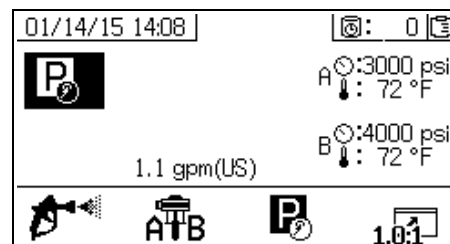



Ratio Mode

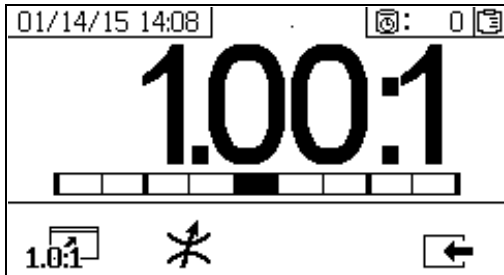

This screen displays the current ratio or the adjust restriction screen. To access this screen, press  .

The ratio displayed is the weight ratio if the machine is in Ratio by Weight Mode. The ratio displayed is the volume ratio if the machine is in Ratio by Ratio Mode.

If the **A:B** field is enabled on the Enable Setup screen, the Spray Mode screen will be replaced by the bar graph screen after 10 seconds of spray time. Press  to return to the Spray Mode screen.



Press  three times to display volume and weight ratio targets. The weight ratio target is only displayed in weight mode.

Icon	Function
	Display Ratio: show the accuracy of the fluid mix ratio.
	Display Adjust Restriction Screen

Adjust Restriction Screen

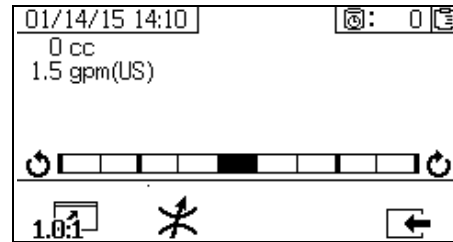





This screen shows the balance of the A and B fluid sides. If the bar graph remains all the way to the right, there is not enough restriction on the B side and adding more restriction (smaller hose diameter) will lower the dosing size. If the bar graph remains all the way to the left, there is too much restriction on the B side. Reducing restriction (larger hose diameter) will reduce dosing size.

The first number below the date and time box is the A side pump dosing size. This value is displayed in volumes of cubic centimeters (cc) and is the volume pumped on the A side when the B side dosing valve is off. Optimizing the restriction of the system will keep this value small and ensure material is mixed well.

The second number below the date and time box is the material flow rate. Higher flow rates will cause larger dosing sizes and will require more optimized restriction. Set the restriction when the flow rate is at the maximum that will be seen in Spray Mode.

Test Screens

Use this screen to run batch dispense tests, pump tests, and down stream valve leak tests.

Icon	Function
	<i>Pump Test:</i> (calibrate) dispenses 750cc of each A and B; verifies pump selection, operation, and metering. In System Weight Mode, this calibrates the system by entering weights.
	<i>Batch Dispense:</i> dispenses proportioned amounts of A and B with a selectable total.
	<i>Down Stream Valve Leak Test:</i> test if valves after the dosing valves hold pressure.
	<i>Test Mode Selection:</i> switch between volume and weight test mode.

Pump Test/Calibrate

Use this screen to dispense a fixed 750 ml volume of material from each metering pump. When the metering pump is active it flashes in black on the screen. When the metering pump completes dispensing it displays gray on the screen. This test will stall the A and B metering pumps on each stroke to verify they hold pressure. See **Pump and Metering Test and Calibration for Ratio by Weight Mode** procedure on page 47.

If the system ratio mode is by volume, pressing  will allow the test to be run either by measuring volumes or weights. If system ratio is by weight (standard on XM PFP systems), then the dispensed materials must be measured by weight.

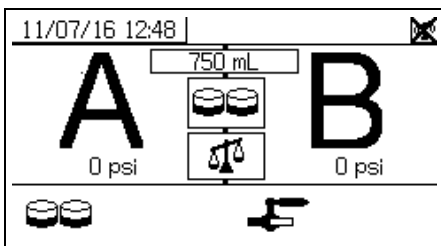

Confirm Pump and Metering Test

This screen displays when the pump test completes without error. There are three variations that affect how the screen is used.

Ratio by Volume Mode - Test by Volume

Enter the volumes of each dispensed material in the respective input boxes on this screen. If the calculated ratio is within the ratio tolerance set on the Setup Ratio Test screen, a check will appear in the box. The results are entered into the USB logs.

The target ratio by volume for this test is set on the **Setup Home** screen on page 68. The tolerance is set on the **Setup Ratio Test** screen on page 71.

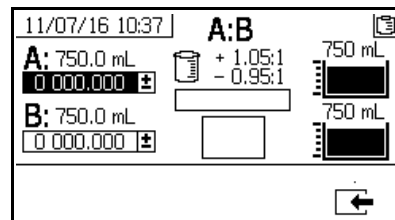

System Ratio Mode by Volume - Test by Volume

Ratio by Volume Mode - Test by Weight

Enter the net weights of each dispensed material in the respective input boxes on this screen. If they are within the ratio tolerance set on the Setup Mode Ratio Test screen, a check will appear in the box. The results are entered into the USB logs.

The target ratio by weight for this test and tolerance is set on the **Setup Ratio Test** screen on page 71.

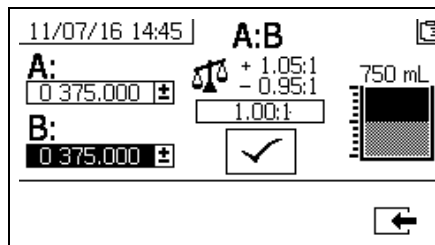

System Ratio Mode by Volume - Test by Weight

Ratio by Weight Mode

This screen displays two boxes where the A and B sample weights are entered to calibrate the machine to run in Ratio by Weight Mode. The weights must be entered in grams.

The target ratio by weight for this test is set on the **Setup Home** screen on page 68. The tolerance is set on the **Setup Ratio Test** screen on page 71.

Once entered, a check will appear in the box. There will still be an X through the scale in the upper right corner until a Ratio Test is performed successfully.

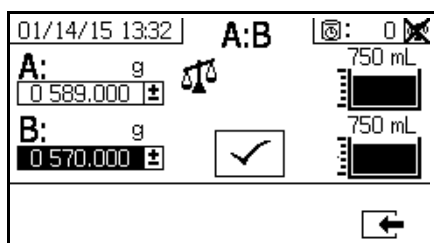

System Ratio Mode by Weight

Batch Dispense or Ratio Test

Use this screen to dispense a selected total volume of material on ratio. For example, 1000 ml at 4:1 = 800 ml of A + 200 ml of B. The total batch volume can be selected from the drop down menu. The dispense material can be used to check the ratio or to mix together and use in production. See **Batch Dispense or Ratio Test** procedure on page 49.

When the metering pump is active it flashes in black on the screen. When the metering pump completes dispensing it displays in gray on the screen.

If the system ratio mode is by volume, pressing  will allow the ratio test to be run either by measuring volumes or weights. If system ratio mode is by weight, then the dispensed materials must be measured by weight.

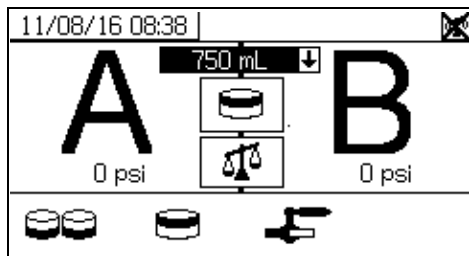

Confirm Batch Dispense Test

This screen displays when the batch dispense test completes without error. This screen displays the selected ratio between the metering pumps and the desired weight of material dispensed from each metering pump. The gray at the bottom of the beaker represents the material dispensed by metering pump A. The black at the top of the beaker represents the material dispensed by metering pump B.

There are three variations that affect how the screen is used:

Ratio by Volume Mode - Test by Volume

Enter the volumes of each dispensed material in the respective input boxes on this screen. If the calculated ratio is within the ratio tolerance set on the Setup Ratio Test screen, a check will appear in the box. The results are entered into the USB logs.

The target ratio by volume for this test is set on the **Setup Home** screen on page 68. The tolerance is set on the **Setup Ratio Test** screen on page 71.

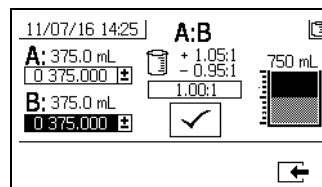

System Ratio Mode by Volume - Test by Volume

Ratio by Volume Mode - Test by Weight

Enter the weights of each dispensed material in the respective input boxes on this screen. If calculated ratio is within the ratio tolerance set on the **Setup Ratio Test** screen, a check will appear in the box. The results are entered into the USB logs.

The target ratio by weight for this test and tolerance is set on the **Setup Ratio Test** screen on page 68.

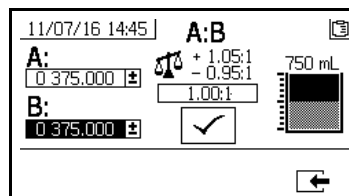

System Ratio Mode by Volume - Test by Weight

Ratio by Weight Mode

Enter the weights of each dispensed material in the respective input boxes on this screen. The weights must be entered in grams. If calculated ratio is within the ratio tolerance set on the Setup Ratio Test screen (on page 71), a check box will appear in the box. The results are entered into the USB logs.

The target ratio by weight for this test is set on the **Setup Home** screen on page 68. The tolerance is set on the **Setup Ratio Test** screen on page 71.

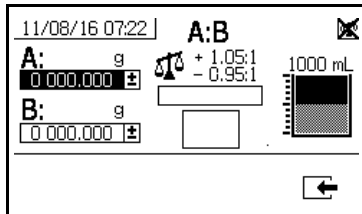

System Ratio Mode by Weight

Down Stream Valve Leak Test

Use this screen to test for closed or worn valves down stream of the A and B dosing control valves. It can be used to test the mix manifold shutoff/check valves or any remote circulation valves.

While running the test, if there is continuous metering pump movement on the A or B side, an error will be issued. The error indicates a leak in the valve.

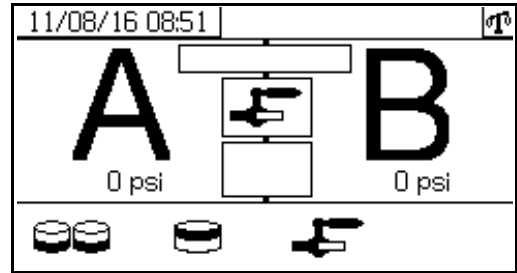

Confirm Valve Leak Test

This screen displays when the valve leak test completes and indicates whether the test was successful.

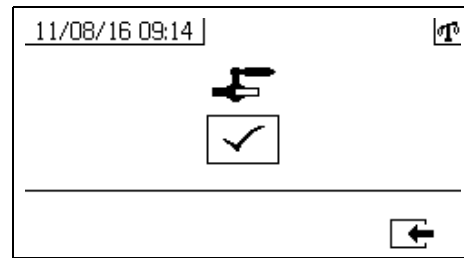

Information Screens

Use this screen to view alarm diagnostic information, alarm logs, and pump batch and grand totals. These screens also enable users to view maintenance information for pump and check valves, including the maintenance schedule.

If the potlife timer is enabled, the Flush Confirm

icon  displays.

Alarm

The Alarm screen displays the specific alarm code. There are two levels of error codes: alarms and advisories. A solid bell icon with an exclamation point and three audible alerts indicate a alarm. And an outlined hollow bell icon and a single audible alert indicate an advisory.







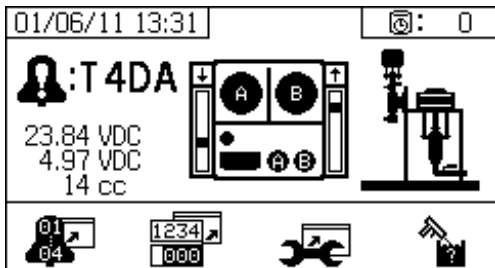

Additionally, this screen displays the location of the error with the top view and side view of the system. Refer to the following table and subsections for more details

The first number below the alarm code is the main power supply voltage used by the electronic modules. The voltage should read between 23 VDC - 25 VDC for non-hazardous location systems, and 10-14 VDC for the hazardous location systems.

The second number below the alarm code is the power supply voltage used by the system sensors. This voltage should read between 4.9-5.1 VDC.



The third number below the alarm code is the A side pump dosing size. This value is displayed in volumes of cubic centimeters (cc) and is the volume pumped on the A side when the B side dosing valve is off. Optimizing the restriction of the system will keep this value small and ensure material is mixed well.



Icon	Function
	Go to Alarm log. Use up and down arrows to scroll through list of the past 16 errors.
	Go to totalizer screen. Allows users to view the grand and batch totals for each pump and both pumps combined.
	Go to maintenance screen. Allows user to view maintenance information. See Maintenance Setup 2 , page 73.
	Flush confirm. Use when the potlife timer is enabled. Press button to confirm flush before a potlife advisory is issued.
	Amount of material moved through pump that will result in a maintenance warning.
	Amount of material moved through dosing valve that will result in a maintenance warning.
	Number of days between maintenance cycles that will result in a reminder advisory.
	Clear batch totalizers or maintenance counters.

Alarm Log

Use this screen view details regarding alarms received, including the date, time, and alarm code for the last 16 alarms. Up to four pages of alarms are available.

Press  to access the alarm log. The press  and  to scroll through each page of alarms.

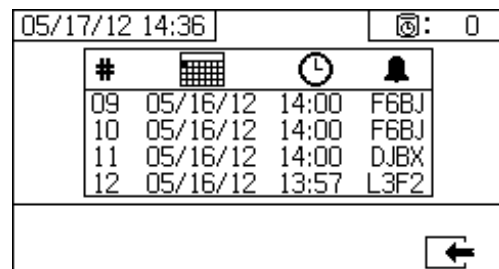

Totalizers and Job Number



Use this screen view the grand and batch totals for each pump and both pumps combined. The units of measurement are displayed on the bottom of the screen and displayed in the units of measurement selected during setup.

Grand total is the amount of material the system has dispensed during its lifetime. Batch total is the amount of material dispensed since the last user reset.









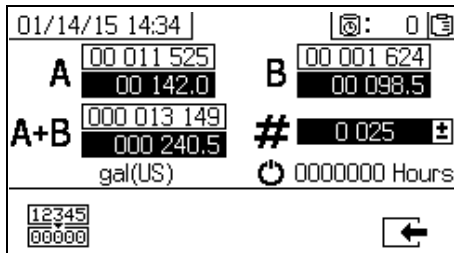



A job number can be entered at the beginning of each spray job. This helps to organize the USB spray log.

Clear Batch Totalizer







To clear the batch totalizer values for A, B, and A+B,

press   to set all values to zero.



Icon	Function
  	Displays batch total and grand total for pump A. The grand total is displayed at the top, and the batch total is displayed at the bottom.
  	Displays batch total and grand total for pump B. The grand total is displayed at the top, and the batch total is displayed at the bottom.
  	Displays batch total and grand total for both pumps combined. The grand total is displayed at the top, and the batch total is displayed at the bottom.
  	Displays job number for each spray period.
	Number of hours system has been running

Change Job Number

1. Press  to highlight the first digit. Press  and  to change the number and press  and  to move to the next digit. Press  to save the number or  to cancel.

Maintenance 1 Screen

Use this screen view setpoints for the amount of material that needs to move through both pumps and dosing valves that will result in a maintenance warning.

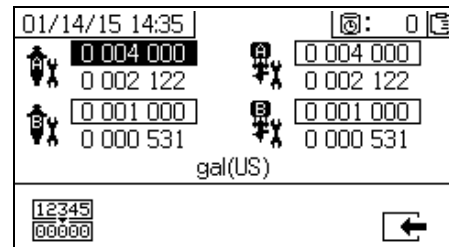



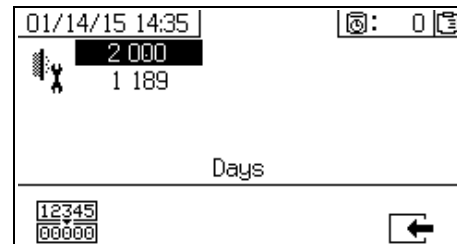

Maintenance 2 Screen

Use this screen view number of days between changing the main incoming air filter before a reminder advisory is issued.



Reset Maintenance Counter

1. Press  and  to scroll through and select the maintenance field to reset.
2. Press   to reset the maintenance counter to zero.

Supply Screen

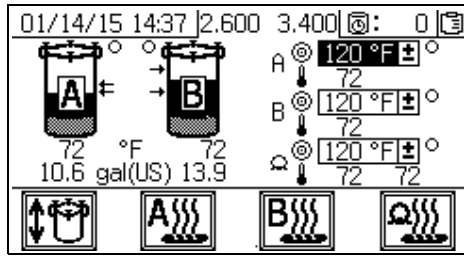

Use these screens to turn on and off automatic tank filling, turn on and off the fluid heaters and hose heat, and change temperature setpoints for each fluid heater and for the hose heat.

When automatic tank filling is on, the feed pump will begin pumping fluid into the tank when the fluid level goes below the bottom arrow. It will continue filling until the fluid level reaches the upper arrow. When the feed pump is running, the small circle on the screen next to the tank will have a black background. In order for automatic tank filling to run, the director valve (3DC) must be in the DOWN position, and the RAM slider valve (DA) and air motor slider valve (DF) must both be in the ON position with proper air pressure air supplied to the RAM and air motor. See **Feed Pump Air Controls** on page 14.

This screen also displays the current volume of each tank and the current temperature measured at each fluid heater, at the hoses, and in each tank.

Icon	Function
	Turn on and off automatic tank filling
	Turn on and off the A fluid heater
	Turn on and off the B fluid heater
	Turn on and off the hose heat

Press to three times display additional information.



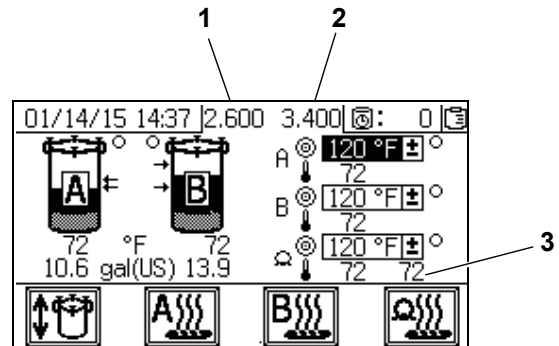

Additional Information	
1	Tank level sensor A (volts)
2	Tank level sensor B (volts)
3	Water/glycol mixture temperature at heater



Automatically Displayed Screens

Potlife Screen

This screen automatically displays when a potlife advisory occurs. The screen automatically closes when the advisory ends or the user presses the flush confirm button. Refer to the following table for more details.

Icon	Function
	Advisory has been issued.
	Potlife timer is enabled.
	Time after potlife expires. Starts at 0.00 and counts down in negative one minute intervals.
	Press to mute advisory buzzer.
	Press to confirm that mixed hose has been flushed. Resets potlife timer.

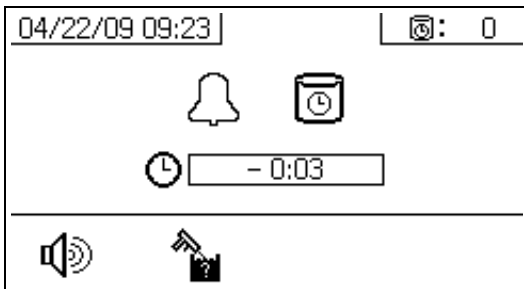







USB Screen

This screen automatically displays and the selected log(s) automatically starts downloading when a USB flash drive is inserted into the control box.

Inserting the USB flash drive while the sprayer is running will automatically stop sprayer operation. Removing the USB flash drive automatically closes the USB screen.

The log selected for current download is displayed in the single box next to the USB icon. The other available logs are displayed in the boxes on the right side of the screen. Refer to the following table for more details.

Icon	Function
	Flashes while data download is in process.
	Check mark appears after download completes. Indicates download was successful. If download was not successful,  appears.
	Displays total memory to download and remaining memory left to download.
	Displays time remaining for log download to complete.
	Press to cancel download. If download is canceled, remove USB flash drive.
	Indicates which log(s) will be downloaded.

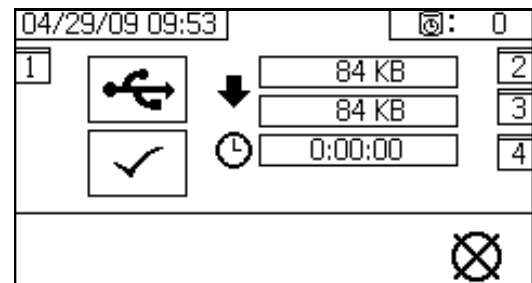

Recommended USB Flash Drives

It is recommended that users use the USB flash drive (17L724) included with the PFP sprayer for data download.

Appendix B - Alarms

Alarms Overview

View Alarms

When an alarm occurs the alarm information screen automatically displays. It shows the current alarm code along with a bell icon. It also shows the alarm location with top and side views of the sprayer.

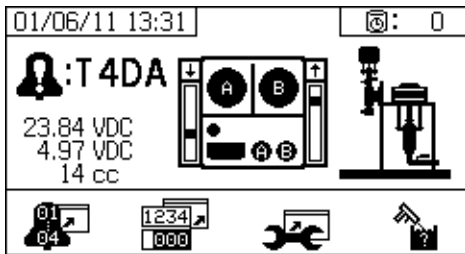

There are two levels of alarms: warnings and advisories. A bell icon indicates an alarm. A solid bell icon with an exclamation point and three audible alerts indicate a warning. And an outlined hollow bell icon and a single audible alert indicate an advisory.

Advisories are notifications that require attention but not immediately. Alarms require immediate correction; therefore, sprayer operation automatically stops.

This screen also shows diagnostic information. There are three lines of data on the left side. The top line shows the power supply. This should be:

- Non-Hazardous PFP: 23-25 Volts
- Hazardous PFP: 10-14 Volts

The middle line shows the voltage supplied to all sensors connected to the Advanced Fluid Control Module. This should be between 4.9-5.1 Volts.

The third line shows the A side pump dosing size. This value is displayed in volumes of cubic centimeters (cc) and is the volume pumped on the A side when the B side dosing valve is off. Optimizing the restriction of the system will keep this value small and ensure the material is mixed well.

The center of the screen shows linear sensor vertical bar graphs and reed switch information. The A side information is on the left and the B side information is on the right. Linear sensor position is displayed on the bar graph that goes up and down when the metering pump moves. This bar graph should move from top to bottom to match each metering pump stroke.

The state of the two reed switches in each air motor are shown with the arrow above each vertical bar graph.

Icon	Function
	Moving up
	Moving down
	Top changeover
	Bottom changeover
	Both reed switches are active. Start of changeover or motor icing problem.
	Blank: No reed switch signal - error

Diagnose Alarms

See **Alarm Code Troubleshooting** for causes and solutions to each alarm code.

Clear Alarms

Press to clear alarms and advisories. From the alarm information screen, press to return to the run (fluid control) screen.

Alarm Code Key

Use the following table as a quick guide to determine alarm code meaning.

Digit 1		Digit 2		Digit 3		Digit 4	
Code	Event	Code	Mode (Char 2)	Code	Location (Char 3)	Code	Zone (Char 4)
A	Current	1	Low Alarm	A	Material A	1	Tank A
F	Flow	2	Low Deviation	B	Material B	2	Tank B
L	Tank Level	3	High Deviation	C	Controller	A	Heater A
P	Pressure	4	High Alarm	D	Output Discharge	B	Heater B
R	Ratio	5	Calibration	F	Input Feed	C	Level Sensor A
T	Temperature	6	Sensor Failure	I	Internal	D	Level Sensor B
V	Voltage	7	Unexpected Non-Zero Value	M	Power Supply	E	Hose
		8	Unexpected Zero Value	P	Pneumatic Supply	H	Heater Hose
				R	Recirculation	J	Linear Sensor
C	Communication	A	Loss			K	Reed Switch
						P	Display
D	Pump	A	Runaway			T	Temperature Control Module
		D	Cavitation			X	System
		E	Time-out				
		F	Stall Up				
		G	Stall Down				
		J	Linear Sensor				
		K	Reed Switch				
M	Maintenance	A	Pump				
		E	Valve				
		G	Filter				
Q	Proportioning	D	Overdose				
		P	Potlife				
		T	Dosing Time				

Possible Alarms by Mode

The following table outlines the alarms that you may receive while operating the system. The alarms are categorized according to each mode.

Mode	Control Logic	Alarms
Spray	Dosing valves close for startup test; green light blinks.	--
	If fluid pressure is under 1000 psi (7 MPa, 70 bar), STOP.	P1AX
	If pumps move (indicating internal leakage), STOP.	F7AX, F7BX
	If fluid pressure is more than 103% of allowed maximum, air motor shuts off until fluid pressure drops.	None
	If is pressure more than 110% of allowed maximum, STOP.	P4BX
	Dosing valve A opens, and dosing valve B cycles to maintain ratio.	--
	A and B blue lights illuminate when dosing valves are operating.	--
	If there is not enough B component to hold ratio, dosing valve A closes momentarily.	R5BE
	If A or B component is more than 5% off ratio setpoint, STOP.	R1BE, R4BE
	If A dose size is too large, STOP.	QDAE
	A and B dosing valves close momentarily at each pump changeover.	--
	Spray mode turned on with system in weight mode and uncalibrated	R5DX
Park	Both dosing valves open; A and B blue lights turn on.	--
	User opens circulation valves or sprays gun. When pump reaches bottom stroke the blue light turns off.	--
	If park does not complete in 10 minutes, turn off air to both motors.	DEAX, DEBX
Circulation	A and/or B dosing valves close and motor air turns on.	--
	If fluid pressure exceeds 3000 psi (21.0 MPa, 210 bar) on the A pump, receive yellow light advisory.	P4AX
	If fluid pressure exceeds 5600 psi (39.2 MPa, 392 bar) on the A pump, STOP.	P4AX
	If no movement in 10 minutes, turn off air to both motors.	DEAX, DEBX
	Pump did not move for 5 seconds while in circulation mode.	F8RX
Pump Test	Both dosing valves close; green light blinks.	--
	If fluid pressure is under 1500 psi (10.3 MPa, 103 bar), STOP.	P1AX, P1BX
	If pumps move (indicating leakage) STOP.	F7AX, F7BX
	Turn on A blue light, open A dosing valve, user opens sampling valve.	--
	Close A dosing valve on upstroke; check for no movement.	DFAX
	Close A dose valve on down stroke; check for no movement.	DGAX
	Open A dose valve and dispense total of 750 ml material, close valve, turn off blue light.	--
	Repeat for B side.	DFBX, DGBX
	If both pumps pass pump test, display shows two beakers of 750ml each.	--

Mode	Control Logic	Alarms
Batch Dispense Test	User selects total volume desired.	--
	Open A dosing valve, turn on blue light, user opens sampling valve, turn off blue light when complete.	--
	Open B dosing valve, turn on blue light, user opens sampling valve, turn off blue light when complete.	--
	Display shows volume of A and B components at end of batch dispense test.	--
Valve Test	If fluid pressure is not 1000 psi (7 MPa, 70 bar), STOP.	P1AX, P1BX
	Check for no movement of pumps (stall within 10 seconds).	F7AX, F7BX

Alarm Code Troubleshooting

See PFP Plural-Component Sprayers Repair-Parts manuals for non-alarm based troubleshooting.

* *Indicates the alarm is user-defined.*

Alarm Code	Alarm Problem	When Active	Cause	Solution
A4DA A4DB	A/B Material Heater Over-Current Alarm	Always	Temperature Control Module is bad.	Replace module.
			Heater is bad.	Repair heater.
A4DH	Hose Heater Over-Current Alarm	Always	Temperature Control Module is bad.	Replace module.
			Heater is bad.	Repair heater.
A8DA A8DB	A/B Heater No Current Alarm	Always	Temperature Control Module is bad.	Replace module.
			Heater is bad.	Repair heater.
			Heater wiring is bad.	Fix heater wiring
A8DH	Hose Heater No Current Alarm	Always	Temperature Control Module is bad.	Replace module.
			Heater is bad.	Repair heater.
			Heater wiring is bad.	Fix heater wiring
A9DA A9DB	A/B Material Heater Unexpected Current Alarm	Always	Temperature Control Module is bad.	Replace module.
			Heater is bad.	Repair heater.
A9DH	Hose Heater Unexpected Current Alarm	Always	Temperature Control Module is bad.	Replace module.
			Heater is bad.	Repair heater.
CACA CACB	Temperature Control Module Heater Loss Of Communication Alarm with A/B Material Heater	Always	Network communication cable is bad.	Replace communication cable.
			Temperature Control Module network address is wrong.	Set module network address.
			Temperature Control Module is bad.	Replace module.
CACH	Temperature Control Module Loss of Communication Alarm with Hose Heater	Always	Network communication cable is bad.	Replace communication cable.
			Temperature Control Module network address is wrong.	Set module network address.
			Temperature Control Module is bad.	Replace module.
CACP	Display Has No Signal	Always	No display communication signal.	Check cable connections. Replace display.
				See XM PFP Repair manual.
			Machine powered down in spray mode.	Press stop button before turning off power.

Alarm Code	Alarm Problem	When Active	Cause	Solution
CACT	Temperature Control Module Loss of Communication	Always	Network communication cable is bad.	Check cable connections.
DAAX DABX	Pump Runaway; Above 80 CPM For 10 Sec.	Always	No material in pump or lines; no fluid restriction.	Refill material in tank or hoses; install fluid tip.
DDAX DDBX	Pump Cavitation; Dives More Than 1/2 Of Stroke.	Spray	No fluid or valve closed.	Refill supply and open inlet valve.
			Material is too cold or thick.	Increase material temperature to reduce viscosity. See Spray , page 39. Shear material with agitation to reduce viscosity.
			Pump inlet check valve not closing.	Clear debris from check valve. Or replace ball, seat, and seal.
			Feed pump not providing material.	Check feed pump (if used).
			Inlet strainer plugged (if used).	Check and clean strainer. See XM PFP repair manual.
DEAX DEBX	Pump Does Not Move In 10 Minutes.	Park or Pump Test	Recirculation valves were not opened to allow flow.	Open recirculation valves.
DFAX DFBX	Pump Did Not Stall Against Fluid Pressure On Up Stroke Only.	Pump Test	Pump piston check valve, piston packings, or dosing valve are not holding fluid pressure.	Flush pump. See General Tips , page 61. Recheck. Remove, clean, and repair lower. See XM PFP repair manual.
DGAX DGBX	Pump Did Not Stall Against Fluid Pressure On Down Stroke Only.	Pump Test	Pump inlet check or dose valve is fouled, or damaged.	Remove inlet housing & clean and inspect. See XM PFP repair manual.
DJAX DJBX	Pump Motor Linear Sensor Has No Signal.	Always	No linear sensor signal from motor.	Swap A and B sensors. Replace sensor if problem follows sensor. See XM PFP repair manual.
			Linear sensor plugged in while power is on.	Power sprayer off and back on. Do not plug in linear sensor while power is on.
			Bad connection inside fluid control module.	Replace fluid control module. See XM PFP repair manual.
	Pump Motor Linear Sensor Is Out Of Range.	Always	Linear sensor is beyond range.	Replace sensor or sensor magnet. See XM PFP repair manual.
			Sprayer is not properly grounded.	See Grounding , page 19.
DKAX DKBX	Pump Motor Reed Switch Failure; Missing Signals From Both Switches.	Always	Bad motor cable connections, or bad reed switch.	Swap A and B motor cables. Replace cable if problem persists. Otherwise replace reed sensor assembly. See XM PFP repair manual.
			Reed switch cable is plugged in while power is on.	Power sprayer off and back on. Do not plug in reed switch cable while power is on.
			Bad connection inside fluid control module.	Replace fluid control module.

Alarm Code	Alarm Problem	When Active	Cause	Solution
F6AJ	A Air Motor Linear Sensor Jump Advisory.	Always	System ran out of fluid.	Add fluid to the system.
			Linear sensor is bad.	Replace linear sensor.
F6AK	A Air Motor Reed Switch Signal Missing Advisory.	Always	Reed switch does not see the air motor magnet.	Replace air motor reed switch magnet.
			Reed switches are bad.	Replace air motor reed switch. Prevent air motor icing. See advisory P9AX and P9BX.
			Air motor is icing.	
F6BJ	B Air Motor Linear Sensor Jump Advisory.	Always	System ran out of fluid.	Add fluid to the system.
			Linear sensor is bad.	Replace linear sensor.
F6BK	B Air Motor Reed Switch Signal Missing Advisory.	Always	Reed switch does not see the air motor magnet.	Replace air motor reed switch magnet.
			Reed switches are bad.	Replace air motor reed switch. Prevent air motor icing. See advisory P9AX and P9BX.
			Air motor is icing.	
F7AX F7BX	System Detects Unexpected Pump Movement (Fluid Flow).	Spray	Recirculation valve or dosing valve open or leaking for more than five seconds.	Close or repair recirculation valve, and run Pump Test. See Pump and Metering Test and Calibration for Ratio by Weight Mode , page 47.
F8RX	No movement occurred in circulation mode	Circulation	Pump did not move for 5 seconds while in circulation. User may have attempted to spray in circulation mode.	Use spray mode for spraying.
L2F1 L2F2	Tank Level Low Advisory	Spray and Tank	Tank level less than 10% below tank empty setpoint for 3 seconds.	Add material to tank.
			Air solenoid is bad.	Replace air solenoid.
				Increase air pressure to solenoid.
L3F1 L3F2	Tank Level High Advisory	Spray and Tank	Tank level greater than 10% above tank full setpoint for 3 seconds.	Lower the tank level.
			Air solenoid to feed pump is bad.	Replace air solenoid.
			Fluid expanded when air pressure was removed.	Increase air pressure to solenoid.
L4F1 L4F2	Tank Level High Alarm	Always	Tank level greater than 90% of total tank volume for 3 seconds.	Lower the tank level.
			Fluid expanded when air pressure was relieved.	Lower the tank full setpoint.
			Sensor rod is damaged.	Replace sensor rod.
L6FC L6FD	Tank Level Sensor Failure Alarm	Always	Cable is disconnected or bad	Replace level sensor
				Turn all sensor DIP switches to off
				Connect level sensor cable to system
*MAAX *MABX	Maintain Pump.	Always, if enabled	Pump usage exceeds user-set limit. Maintenance due.	Service pump. See pump manual listed on page 4.

Alarm Code	Alarm Problem	When Active	Cause	Solution
*MEAX *MEBX	Maintain Dosing Valve.	Always, if enabled	Dosing valve usage exceeds user-set limit. Maintenance due.	Service dosing valve. See pump manual listed on page 4.
*MGPX	Maintain Air Filter.	Always, if enabled	Air filter exceeds user-set limit. Maintenance due.	Service main air filter and control filter regulator.
P1AX P1BX	Pressure Low.	Spray, Pump Test, Leak Test	Fluid pressure is below 1000 psi (7 MPa, 70 bar) for spray mode or below 1500 psi (10.3 MPa, 103 bar) to test modes.	Increase main air regulator.
*P2AX *P2BX	Pressure Exceeded Advisory Limits.	Spray	Pressure exceeded high or low advisory limits for more than 15 seconds.	Same as P5AX or P5BX.
P4AX P4BX	Pressure High.	Always	Fluid pressure is above maximum.	Decrease main air regulator.
P4RE	Pressure High.	Recirculation	Pressure is above maximum advisory limit of 3000 psi (21 MPa, 210 bar) on A side.	Decrease pump air regulator pressure.
P5RE	Pressure High.	Recirculation	Pressure is above maximum warning limit of 5200 psi (35.9 MPa, 359 bar) on A side.	Decrease pump air regulator pressure.
*P5AX *P5BX	Pressure Exceeded Alarm Limits.	Spray	Pressure exceeded high or low alarm limits for more than 15 seconds.	Adjust pump pressure regulator, change tips, or adjust target set point.
P6AX P6BX	Pressure Sensor Failure; No Signal.	Always	Pressure sensor or cable is bad on the side indicated.	Replace sensor and cable assembly. See XM PFP repair manual.
P9AX	A Pump Pressure is Abnormally Low Compared to B Pump Pressure.	Spray	A air motor is icing causing restriction and lower fluid pressure.	Open the air motor de-ice bleed air controls. Allow ice to melt. Dry compressed air. Heat compressed air.
				Use a smaller tip.
			A pump is binding.	Repair lower. See XM PFP repair manual.
P9BX	B Pump Pressure is Abnormally Low Compared to A Pump Pressure.	Spray	A motor is binding.	Repair air motor. See XM PFP repair manual.
			B air motor is icing causing restriction and lower fluid pressure.	Open the air motor de-ice bleed air controls. Allow ice to melt. Dry compressed air. Heat compressed air.
				Use a smaller tip.
			B pump is binding.	Repair lower. See XM PFP repair manual.
			B air motor is binding.	Repair air motor. See XM PFP repair manual.

Alarm Code	Alarm Problem	When Active	Cause	Solution
QDAE	Dosing Size A Alarm	Spray	The fluid dosing size is greater than 45 cc when fast dosing is turned off.	Decrease the air motor velocity with a smaller tip or increase 'B' restriction.
			The fluid dosing size is greater than 30 cc when fast dosing is turned on.	Decrease the air motor velocity with a smaller tip or increase 'B' restriction.
*QPDX	Pot Life Timer Expired. Mixed Fluid Will Cure in Hoses, Mixer, and Gun.	Spray	Have not sprayed enough volume to keep fresh mixed fluid in the integration hose, mixer, whip hose, and spray gun.	Spray fluid, or flush. Resets when you leave spray mode. See Spray , page 39, or Flush Mixed Material , page 43.
QTAE	Dosing Size A Advisory	Spray	The fluid dosing size is greater than 35 cc when fast dosing is turned off.	Decrease the air motor velocity with a smaller tip or increase 'B' restriction.
			The fluid dosing size is greater than 20 cc when fast dosing is turned on.	Decrease the air motor velocity with a smaller tip or increase 'B' restriction.
R1BE	Ratio Low B (Under Dose B); System Delivering Not Enough B Component.	Spray	B dosing valve will not open.	Check for air signal to valve.
			B mix manifold valve closed.	Open green mix manifold valve.
			Pump filter plugged on B side.	Use alternate 30 mesh screen. See manual 311762 for part number. Clean B pump outlet filter. See manual 311762.
R4BE	Ratio High B (Overdose B); System Delivering Too Much B Component.	Spray	B Dosing valve not closing.	Perform Pump Test to test for leakage. See Pump and Metering Test and Calibration for Ratio by Weight Mode , page 47.
				Loosen valve packing nut. See XM PFP repair manual.
				Check air signal at valve top
				Repair valve or air solenoid. See XM PFP repair manual.
			Pump filter plugged on A side.	Clean filter. See manual 311762.
				Use alternate 30 mesh screen. See manual 311762 for part number.
			Inlet air dropping below 80 psi (0.55 MPa, 5.5 bar) while spraying. B dosing valve not closing correctly.	Check air filters. See XM PFP repair manual.
				Use larger air hose.
Use larger compressor.				
Solenoid air regulator set below 80 psi (0.55 MPa, 5.5 bar)	Use smaller gun tips or less guns to reduce flow rate.			
Adjust air regulator.				

Alarm Code	Alarm Problem	When Active	Cause	Solution
R5BE	Dosing Sizes Are Not Optimized.	Spray	Dosing valve is operating near high or low timing limits.	Balance A and B fluid hoses. See XM PFP Mix Manifold manual. Or change 'B' restriction. Check Restriction screen.
R5DX	Uncalibrated system in Weight Mode	Spray	System was not calibrated.	Run the Pump and Metering Test and Calibration for Ratio by Weight Mode , page 47, and Batch Dispense or Ratio Test , page 49 to calibrate system for weight mode. Run system in volume mode.
				Run system in volume mode.
R9BE	System detected five R4BF (Ratio High B) or five R1BF (Ratio Low B) alarms within five minutes. Sprayer shuts down for five minutes for operator to resolve problem.	Spray	See R4BE or R1BE alarm causes.	See R4BE or R1BE alarm solutions. Flush mixed material if necessary, and purge off-ratio mixed material in hose.
*T2DA *T2DB	Temperature Exceeded Advisory Limits.	Spray	Fluid temperature exceeded high or low limits for more than four minutes.	Same as T5DA or T5DB.
T3CA T3CB	A/B Material Heater Temperature Control Module Over Temperature Advisory	Always	Module is bad.	Replace module. Cool system down.
T3CH	Hose Heater Temperature Control Module Over Temperature Advisory	Always	Module is bad.	Replace module. Cool system down.
T4CA T4CB	A/B Material Heater Temperature Control Module Over Temperature Alarm	Always	Module is bad.	Replace module. Cool system down.
T4CH	Hose Heater Temperature Control Module Over Temperature Alarm	Always	Module is bad.	Replace module. Cool system down.
T4CX	Temperature Over Temperature Switch	Always	Over temperature switch jumper unplugged.	Replace jumper.
T4DA T4DB	A/B Material Heater High Temperature RTD 1 Alarm	Always	Heater bad.	Repair heater.
			RTD bad.	Replace RTD.
				Check RTD. See RTD Cables, page 66.
T4DE	Hose High Temperature RTD 1 Alarm	Always	Heater bad.	Repair heater.
			Splitter cable bad.	Replace splitter cable
			RTD bad in hose bundle.	Replace RTD in hose bundle.

Alarm Code	Alarm Problem	When Active	Cause	Solution
T4DH	Hose Heater High Temperature RTD 2 Alarm	Always	Heater bad.	Repair heater.
			Splitter cable bad.	Replace splitter cable
			RTD bad in hose heater outlet.	Replace RTD in hose water heater outlet.
*T5DA T5DB	A/B Material Heater Temperature Exceeded Alarm Limits.	Spray	Fluid temperature exceeded high or low alarm limits for more than four minutes.	If fluid temperature is too low, return to circulation mode to increase fluid temperature. Adjust heater set point if needed. See Spray , page 39.
				If fluid temperature is too high, lower heater set point, and return circulation mode to cool. See Spray , page 39.
				Adjust temperature target setpoint. See Spray , page 39.
T6DA T6DB	A/B Material Heater RTD 1 Bad Alarm	Always	RTD bad.	Replace RTD.
			RTD disconnected.	Connect sensor to system.
				Check RTD. See Check RTD Cables and FTS , page 96.
T6DE	Hose RTD 1 Bad Alarm	Always	RTD bad.	Replace RTD.
			RTD disconnected.	Connect sensor to system.
T6DH	Hose Heater RTD 2 Bad Alarm	Always	RTD bad.	Replace RTD in hose heater outlet.
			RTD disconnected.	Connect sensor to system.
T6F1 T6F2	Tank RTD Failure Advisory	Always	Temperature sensor is bad	Replace temperature sensor
			Cable is disconnected or bad	Connect temperature sensor cable to system.
T8DA T8DB	A/B Material Temperature Not Rising Alarm	Heater A/B	Heater bad.	Repair heater.
			Heater voltage too low.	Increase heater voltage to 200 - 240 VAC.
T8DH	Hose Temperature Not Rising Alarm	Hose Heater	Heater bad.	Repair heater.
			Heater voltage too low.	Increase heater voltage to 200 - 240 VAC.
V1IT	Low Voltage CAN	Always	24 VDC power supply.	Check voltage of power supply. Voltage should be 23-25 VDC. If out of tolerance, adjust or replace power supply.
V1MA V1MB	A/B Material Heater Low Line Voltage Alarm	Always	Temperature Control Module power cable is disconnected.	Plug in module power cable.
			Heater circuit breaker is off	Turn on heater circuit breaker.
V1MH	Hose Heater Low Line Voltage Alarm	Always	Temperature Control Module power cable is disconnected.	Plug in module power cable.
			Heater circuit breaker is off	Turn on heater circuit breaker.

Alarm Code	Alarm Problem	When Active	Cause	Solution
V2MX	Voltage Low Control Advisory	Always	Voltage dropping below 9 Vdc from power supply.	Change air filter in control filter regulator. See XM PFP repair manual.
				Check voltage on information screen.
V4IT	High Voltage CAN	Always	24 VDC power supply.	Check voltage of power supply. Voltage should be 23-25 VDC. If out of tolerance, adjust or replace power supply.
V4MA V4MB	A/B Material Heater High Line Voltage Alarm	Always	Temperature Control Module is bad.	Replace module.
			Heater is bad.	Repair heater.
V4MH	Hose Heater High Line Voltage Alarm	Always	Temperature Control Module is bad.	Replace module.
			Heater is bad.	Repair heater.

Check RTD Cables and FTS

1. Perform the **Pressure Relief Procedure**, page 45.
2. Disconnect the RTD cable at the fluid heater.
3. Test the RTD cable with an ohmmeter between pins of cable connector C.
4. Make sure to test both A and B side RTD's when troubleshooting, regardless of error code specific to one side.

NOTE: Do not touch the outer ring with the test probe.

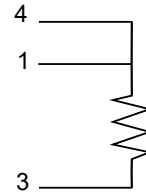
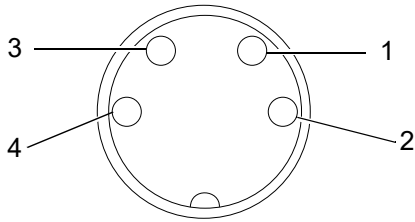

Pins	Result
1 to ground 4 to ground 3 to ground	infinity (open), if value above 0 Ω , replace RTD, see Viscon HF Heater manual for repair.
1 to 3 4 to 3	1000 Ω +/- 12% across RTD element
1 to 4	Should be 0 Ω , if value is above 0 Ω , replace RTD, see Viscon HF Heater manual for repair.

Pin	Wire Color	Signal
1	Red	Excitation
2	NA	Unused
3	White	RTD Element
4	Red	Lead Resistance

Dimensions

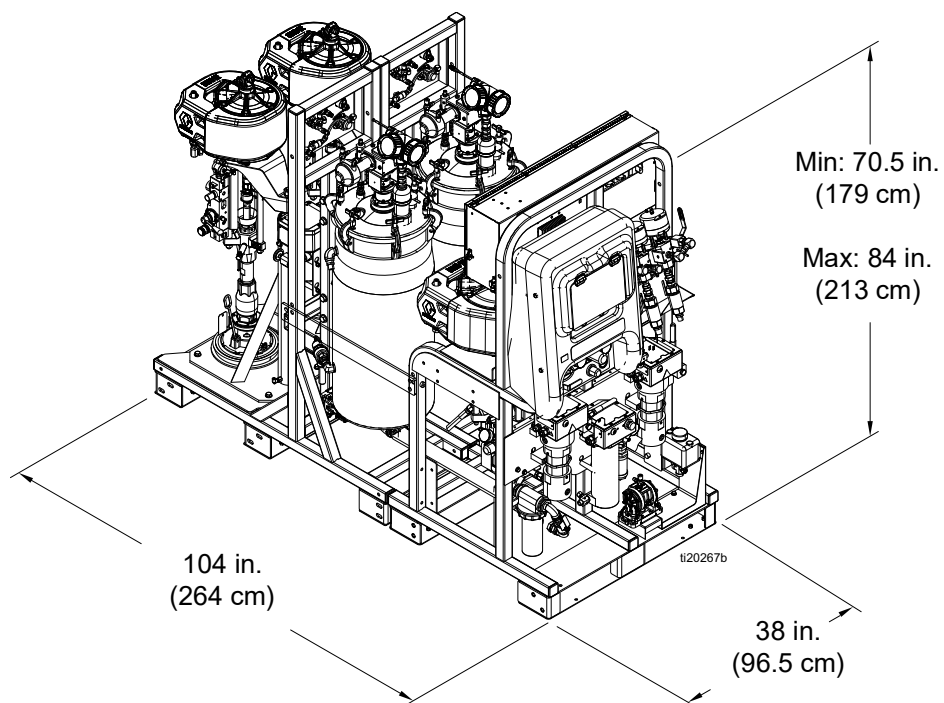
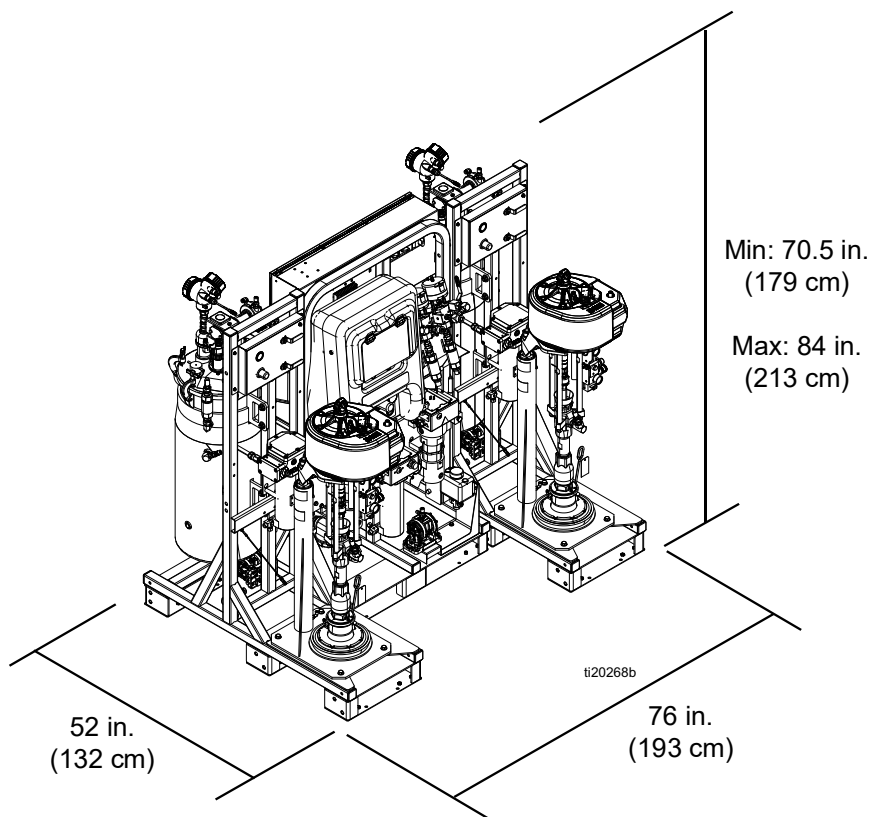

Technical Specifications

XM PFP Proportioner		
	US	Metric
Ratio Tolerance Range (before alarm)	+/- 5%	
Maximum Flow Rate (measured with oil)	3 gallons per minute	13.6 liters per minute
Fluid Viscosity Range	Handles mastic materials which are loaded into heated tanks with ram-fed priming piston pumps	
Air Inlet	1 in. npt(f)	
Fluid Inlets	Pail (Feed Pumps)	
Maximum Fluid Working Pressure for A and B Materials	6000 psi	41 MPa, 414 bar
Maximum Fluid Working Pressure for Flushing Fluid	4500 psi	31 MPa, 310 bar
Maximum Fluid Working Pressure for Heating Fluid	100 psi	0.7 MPa, 7 bar
Maximum Fluid Temperature	160°F	70°C
System Inlet Supplied Air Pressure Range	80-150 psi	0.5-1.0 MPa, 5.5-10.3 bar
Maximum Main Pump Air Pressure	100 psi	0.7 MPa, 7 bar
Maximum Feed Pump Air Pressure	65 psi	0.45 MPa, 4.5 bar
Maximum Tank Air Pressure	90 psi	0.6 MPa, 6 bar
Air Filtration	40 micron main filter, 5 micron control air filter	
Ambient Operating Temperature Range	32 to 130 °F	0 to 54 °C
Environmental Conditions Rating	Altitude up to 13,123 ft	Altitude up to 4000 m
System Weight (empty, no fluid)	2175 lb	987 kg
Mix Ratio Range		
262869, 262898, 262943	1.5:1 to 4:1	
24W626, 262945	1:1 to 1.5:1	
Air Consumption		
Minimum	100 scfm	2.8 meter ³ /min
Maximum	250 scfm	7.1 meter ³ /min
Typical Application	125-175 scfm	3.5-5.0 meter ³ /min
Power Requirements		
Voltage (can be set with jumpers)	Option 1: 200-240 VAC, 3 phase DELTA (3 wire plus ground) Option 2: 350-415 VAC, 3 phase WYE (4 wire including neutral plus ground)	
Wattage	18,800 watts (non-hazardous location) 18,900 watts (hazardous location) 22,900 watts (with hazardous location flush water heater) 23,400 watts (with optional non-hazardous flush water heater)	
Amps	200-240 VAC, 3-phase models DELTA: 63 Amps per phase full load 350-415 VAC, 3-phase models WYE: 40 Amps per phase full load	

XM PFP Proportioner		
	US	Metric
Storage		
Maximum Storage Time	5 years	
Storage Maintenance	To maintain original performance, replace soft seals after 5 years of inactivity.	
Ambient Storage Temperature Range	30 to 160 °F	1 to 71 °C
Lifetime		
Lifetime Use	Lifetime varies with use, materials sprayed, storage methods, and maintenance. Life minimum is 25 years.	
Lifetime Use Maintenance	Replace leather packings every five years or less based on use.	
End of Life Disposal	If the sprayer is in a condition that it can no longer operate, the sprayer should be taken out of service and dismantled. Individual parts should be sorted by material and disposed of properly. Key construction materials can be found in the Materials of Construction Section. Electronic components are RoHS compliant and should be disposed of properly.	
Graco Four-Character Date Code		
Example: A18B	Month (first character) A = January, Year (second and third characters) 18 = 2018, Series (fourth character) B = serial control number	
Wetted Parts		
Wetted Parts	Aluminum, ductile iron, leather, nylon, plated carbon steel, polyethylene, PTFE, stainless steel, tungsten carbide, UHMWPE	
Purge Requirements (For hazardous models only. Purge air is filtered to instrumentation quality by filters listed above)		
Minimum Purge Time	3 minutes	
Minimum Purge Flow	4.8 scfm	
Maximum Air Temperature	104° F	40° C
Air Filter	3 micron	
Noise (dBA)		
Sound Pressure *	92.2 dBA at 100 psi	92.2 dBA at 0.7 MPa, 7 bar
	85.8 dBA at 70 psi	85.8 dBA at 0.48 MPa, 4.8 bar
Sound Power **	103.2 dBA at 100 psi	103.2 dBA at 0.7 MPa, 7 bar
	96.8 dBA at 70 psi	96.8 dBA at 0.48 MPa, 4.8 bar
* Sound pressure measured 3.3 feet (1 meter) from equipment.		
** Sound power measured per ISO-9614-2.		

California Proposition 65

CALIFORNIA RESIDENTS

 **WARNING:** Cancer and reproductive harm – www.P65warnings.ca.gov.

Graco Standard Warranty

Graco warrants all equipment referenced in this document which is manufactured by Graco and bearing its name to be free from defects in material and workmanship on the date of sale to the original purchaser for use. With the exception of any special, extended, or limited warranty published by Graco, Graco will, for a period of twelve months from the date of sale, repair or replace any part of the equipment determined by Graco to be defective. This warranty applies only when the equipment is installed, operated and maintained in accordance with Graco's written recommendations.

This warranty does not cover, and Graco shall not be liable for general wear and tear, or any malfunction, damage or wear caused by faulty installation, misapplication, abrasion, corrosion, inadequate or improper maintenance, negligence, accident, tampering, or substitution of non-Graco component parts. Nor shall Graco be liable for malfunction, damage or wear caused by the incompatibility of Graco equipment with structures, accessories, equipment or materials not supplied by Graco, or the improper design, manufacture, installation, operation or maintenance of structures, accessories, equipment or materials not supplied by Graco.

This warranty is conditioned upon the prepaid return of the equipment claimed to be defective to an authorized Graco distributor for verification of the claimed defect. If the claimed defect is verified, Graco will repair or replace free of charge any defective parts. The equipment will be returned to the original purchaser transportation prepaid. If inspection of the equipment does not disclose any defect in material or workmanship, repairs will be made at a reasonable charge, which charges may include the costs of parts, labor, and transportation.

THIS WARRANTY IS EXCLUSIVE, AND IS IN LIEU OF ANY OTHER WARRANTIES, EXPRESS OR IMPLIED, INCLUDING BUT NOT LIMITED TO WARRANTY OF MERCHANTABILITY OR WARRANTY OF FITNESS FOR A PARTICULAR PURPOSE.

Graco's sole obligation and buyer's sole remedy for any breach of warranty shall be as set forth above. The buyer agrees that no other remedy (including, but not limited to, incidental or consequential damages for lost profits, lost sales, injury to person or property, or any other incidental or consequential loss) shall be available. Any action for breach of warranty must be brought within two (2) years of the date of sale.

GRACO MAKES NO WARRANTY, AND DISCLAIMS ALL IMPLIED WARRANTIES OF MERCHANTABILITY AND FITNESS FOR A PARTICULAR PURPOSE, IN CONNECTION WITH ACCESSORIES, EQUIPMENT, MATERIALS OR COMPONENTS SOLD BUT NOT MANUFACTURED BY GRACO. These items sold, but not manufactured by Graco (such as electric motors, switches, hose, etc.), are subject to the warranty, if any, of their manufacturer. Graco will provide purchaser with reasonable assistance in making any claim for breach of these warranties.

In no event will Graco be liable for indirect, incidental, special or consequential damages resulting from Graco supplying equipment hereunder, or the furnishing, performance, or use of any products or other goods sold hereto, whether due to a breach of contract, breach of warranty, the negligence of Graco, or otherwise.

FOR GRACO CANADA CUSTOMERS

The Parties acknowledge that they have required that the present document, as well as all documents, notices and legal proceedings entered into, given or instituted pursuant hereto or relating directly or indirectly hereto, be drawn up in English. Les parties reconnaissent avoir convenu que la rédaction du présente document sera en Anglais, ainsi que tous documents, avis et procédures judiciaires exécutés, donnés ou intentés, à la suite de ou en rapport, directement ou indirectement, avec les procédures concernées.

Graco Information

For the latest information about Graco products, visit www.graco.com.

For patent information, see www.graco.com/patents.

TO PLACE AN ORDER, contact your Graco distributor or call to identify the nearest distributor.

Phone: 612-623-6921 or Toll Free: 1-800-328-0211 Fax: 612-378-3505

All written and visual data contained in this document reflects the latest product information available at the time of publication. Graco reserves the right to make changes at any time without notice.

Original Instructions. This manual contains English. MM 3A2776

Graco Headquarters: Minneapolis

International Offices: Belgium, China, Japan, Korea

GRACO INC. AND SUBSIDIARIES • P.O. BOX 1441 • MINNEAPOLIS MN 55440-1441 • USA
Copyright 2021, Graco Inc. All Graco manufacturing locations are registered to ISO 9001.

www.graco.com
Revision S, July 2024