

PR70fTM

334984R

with Flow Control

EN

Fixed or variable ratio system. For accurate metering, mixing, and dispensing of two-component materials with capability to dispense beads. For professional use only.

Not approved for use in explosive atmospheres or hazardous locations.

3000 psi (21 MPa, 207 bar) Maximum Working Pressure
100 psi (0.7 MPa, 7 bar) Maximum Air Inlet Pressure

See page 4 for model information.



Important Safety Instructions

Read all warnings and instructions in this manual and all related manuals listed on page 3. Save all instructions.

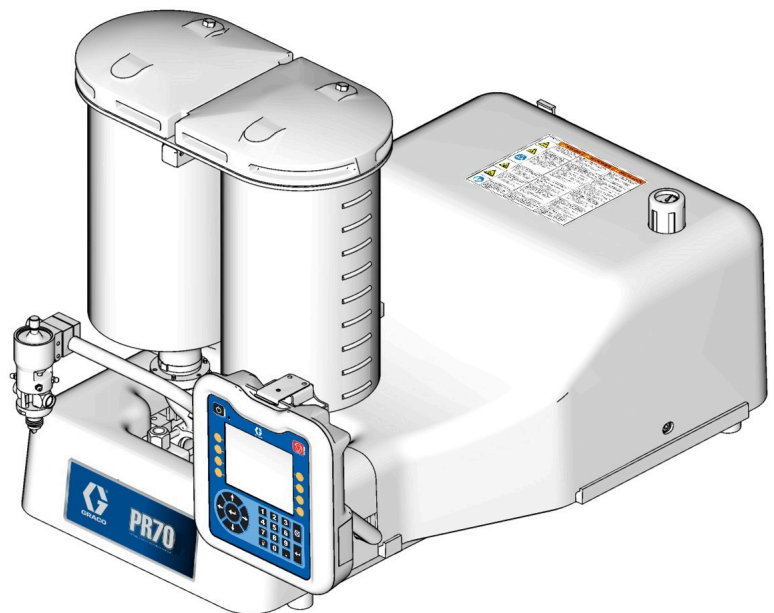

PR70f Shown on Variable Ratio Chassis

Contents

Related Manuals	3	Bead Dispense Operation	63
Models	4	Pump Loading Feature	63
Product Configuration	4	Dynamic Pre-charge Percent	63
Product Pump Selection	11	Dispense Pause or Stepping	64
Warnings	12	Bead Thickness Changes	65
Component Identification	15	Flow Rate Changes Sudden or Gradual Option	66
Advanced Display Module (ADM)	17	External Control Interface Setup	67
Grounding	18	Ready-Output Status Line	68
Installation	18	Fault-Output Status Line	68
Unpacking	18	Dispense Request Line	69
Locate and Mount the PR70f	19	Interrupt - Cancel Line	69
Make Connections	19	Shot Number Select, New Flow Lines	70
Flush the System	19	External Control Interface Timing	70
Startup	20	USB Data	72
Using the Advanced Display Module	20	USB Logs	72
ADM Screen Navigation Diagram	21	Download Procedure	72
ADM Run Home Screen	22	Pressure Relief Procedure	73
Home Screen Features	23	Shutdown	73
Setup	25	Parts	74
Pump Position Calibration	25	Fixed Ratio Base, LC4000, LC4001	74
Pump Size, SG, and Flow Mode	28	Variable Ratio Base, LC4002, LC4003	77
Prime the Dispense Valve	28	Control Bracket (Fixed), LC4004	79
Open the Dispense Valve (ODV) Position	30	Control Bracket (Variable), LC4007	80
Ratio Setting Adjustment (PR70v Chassis Only)	31	Maintenance	81
Phasing Adjustment	33	Schedule	81
Adjust the Dispense Valve Snuff Back	35	Clean the Pump Shafts	81
Flow Control and Restriction	36	Disassemble and Clean the Dispense Valve	81
Flow Change During Active Operator Mode		Flush the Pneumatic Air Motor 82/0216/11	82
Dispense	38	Lubricate the Pneumatic Air Motor	82
Flow Change During Active Shot Mode Dispense	41	Lubricate the Gear Box of the Pneumatic Air Motor	
Edit Functions Setup	41	01/0368-1/11	82
Options Setup	44	Install the Upgrade Token	83
Dispense Check Options	48	Piston Plug Installation	84
Tank Filling Options	49	Pressure Transducer Installation	84
Advanced Functions Setup	50	Troubleshooting	85
Base Purge Operation	52	Appendix A - Error Codes	87
Operation	54	Light Tower Accessory (Optional)	90
Sequence Mode	54	Light Tower (Optional)	90
Variable Ratio Controls	54	System Behavior Descriptions	91
Dispense Amount Accuracy	56	Appendix B - ADM Screen Icons	92
System Data	59	Appendix C - Product Pump Selection Guide	93
Manual Overrides	60	Appendix D - Small Amount Shot Mode Dispensing	102
Status Run Screen	61	Electrical Schematics	107
Shot Counters and Sequences	61	Kits	111
Error History	62	Dimensions	113
Event History	62	Machine with On-Board Tanks	114
		Machine with Off-Board Tanks	115
		Technical Data	116
		California Proposition 65	117
		Graco Standard Warranty	118
		Graco Information	118

Related Manuals

PR70 Operation and Parts Manuals	
Part	Description
312759	PR70™ and PR70v™ with Advanced Display Module Operation-Maintenance Manual
312760	PR70™ and PR70v™ Repair-Parts Manual
312394	PR70™ and PR70v™ Feed Systems Manual
312761	PR70™ and PR70v™ Integrated Heat Instructions-Parts Manual
3A6225	PR70™ and PR70f™ Conversion Kit Instructions Manual
3A8824	PR70™ and PR70v™ Lube Recirculation Kit Instructions-Parts Manual
Dispense Valve Manual	
Part	Description
312185	MD2 Dispense Valve Instructions-Parts Manual

Models

Part No.	Maximum Working Pressure psi (MPa, bar)	Description
LC4000	3000 (21, 207)	PR70 with 3.0 in. (4.56 mm) Air Motor, with Hydracheck
LC4001	3000 (21, 207)	PR70 with 4.5 in. (10.26 mm) Air Motor, with Hydracheck
LC4002	3000 (21, 207)	PR70v with 3.0 in. (4.56 mm) Air Motor, with Hydracheck
LC4003	3000 (21, 207)	PR70v with 4.5 in. (10.26 mm) Air Motor, with Hydracheck

Product Configuration

The PR70f offers a flow control feature that provides a PR70 with the capability to dispense beads of material. This flow control feature can only be used on PR70 configurations that include the Advanced Display Module (ADM).

NOTE: The parts that differentiate the PR70f from a standard PR70 are shown in the **Control Bracket** sections on page 79 and 80.

PR7F - - - - -

Code:	A	B-C	D-E	F	G-H	I-J	K	L	M	N	O	P	Q	R	S	T	U	V
	Air Motor	High Volume Side Piston	Low Volume Side Piston	Controls	High Volume Side Hose	Low Volume Side Hose	Dispense Valve	Mixer	Applicator Mounting	Power Cord	Flow Monitoring	High Volume Side Tank	High Volume Side Tank Cover	Low Volume Side Tank	Low Volume Side Tank Cover	Tank Level Sensors	Heat Zone Controller	Off-Board Tank Stand

An example of the product configurator would be the following configurator code.

PR7F - **J** - **A5** - **A5** - **E** - **A6** - **A6** - **3** - **1** - **2** - **A** - **N** - **3** - **N** - **H** - **N** - **6** - **N** - **N**

Code:	A	B-C	D-E	F	G-H	I-J	K	L	M	N	O	P	Q	R	S	T	U	V
	Air Motor	High Volume Side Piston	Low Volume Side Piston	Controls	High Volume Side Hose	Low Volume Side Hose	Dispense Valve	Mixer	Applicator Mounting	Power Cord	Flow Monitoring	High Volume Side Tank	High Volume Side Tank Cover	Low Volume Side Tank	Low Volume Side Tank Cover	Tank Level Sensors	Heat Zone Controller	Off-Board Tank Stand

The following part number fields apply for the PR70 and PR70v part numbering configurator fields. Shaded items listed in the configurator table below are “Super Standard” items that are typically stocked and provide the best delivery dates.

Code A	Part	Air Motor
A	LC0262	PR70 with 3.0 in. (4.56 mm) Air Motor
B	LC0264	PR70 with 4.5 in. (10.26 mm) Air Motor
C	LC0263	PR70 with 3.0 in. (4.56 mm) Air Motor and Hydracheck
D	LC0265	PR70 with 4.5 in. (10.26 mm) Air Motor and Hydracheck
F	LC0242	PR70v with 3.0 in. (4.56 mm) Air Motor
G	LC0244	PR70v with 4.5 in. (10.26 mm) Air Motor
H	LC0243	PR70v with 3.0 in. (4.56 mm) Air Motor and Hydracheck
J	LC0245	PR70v with 4.5 in. (10.26 mm) Air Motor and Hydracheck
L	LC4000	PR70f with 3.0 in. (4.56 mm) Air Motor and Hydracheck
M	LC4001	PR70f with 4.5 in. (10.26 mm) Air Motor and Hydracheck
P	LC4002	PR70f with 3.0 in. (4.56 mm) Air Motor and Hydracheck
R	LC4003	PR70f with 4.5 in. (10.26 mm) Air Motor and Hydracheck
Code B	Part	High Volume Side Piston and Metering Tube Material
A	LC1__	Nylon Piston, Stainless Steel Metering Tube (last three digits of part number is the mm ² piston size)
B	LC2__	UHMWPE Piston, Stainless Steel Metering Tube (last three digits of part number is the mm ² piston size)
C	LC3__	UHMWPE Piston, Ceramic Metering Tube (last three digits of part number is the mm ² piston size)
Code C	Part	High Volume Piston Size (mm ²)
1		80, Available in Nylon Only
2		100, Available in Nylon Only
3		120, Available in Nylon Only
4		140, Available in Nylon Only
5		160
6		180
7		200
8		220
9		240
A		260
B		280
C		300

F		320
G		360
H		400
J		440
L		480
M		520
R		560
S		600
T		640
U		720
W		800
X		880
Y		960
Z		Custom High Volume side, consult factory (stainless steel only)
Code D	Part	High Volume Side Piston and Metering Tube Material
A	LC1__	Nylon Piston, Stainless Steel Metering Tube (last three digits of part number is the mm ² piston size)
B	LC2__	UHMWPE Piston, Stainless Steel Metering Tube (last three digits of part number is the mm ² piston size)
C	LC3__	UHMWPE Piston, Ceramic Metering Tube (last three digits of part number is the mm ² piston size)
Code E	Part	Low Volume Side Piston Size (mm ²)
1		80, Available in Nylon Only
2		100, Available in Nylon Only
3		120, Available in Nylon Only
4		140, Available in Nylon Only
5		160
6		180
7		200
8		220
9		240
A		260
B		280
C		300
F		320
G		360
H		400
J		440
L		480
M		520

Models

R		560
S		600
T		640
U		720
W		800
X		880
Y		960
Z		Custom Low Volume side, consult factory (stainless steel only)
Code F Part Controls		
B	LC0272	Standard Display Module with 1 Fluid Control Module
D	LC0274	Advanced Display Module with 1 Fluid Control Module
E	LC0275	Advanced Display Module with 2 Fluid Control Modules
Codes G-H, I-J Part High Volume Hose / Low Volume Hose		
A1	LC0801	3/16 in. (4.8 mm) - 2.5 ft (0.6 m)
A2	LC0802	3/16 in. (4.8 mm) - 10 ft (3.0 m)
A3	LC0803	3/16 in. (4.8 mm) - 15 ft (4.6 m)
A4	LC0804	1/4 in. (6.5 mm) - 2.5 ft (0.6 m)
A5	LC0805	1/4 in. (6.5 mm) - 10 ft (3.0 m)
A6	LC0806	1/4 in. (6.5 mm) - 15 ft (4.6 m)
A7	LC0807	3/8 in. (9.5 mm) - 2.5 ft (0.6 m)
A8	LC0808	3/8 in. (9.5 mm) - 10 ft (3.0 m)
A9	LC0809	3/8 in. (9.5 mm) - 15 ft (4.6 m)
AA	LC0810	1/2 in. (13 mm) - 2.5 ft (0.6 m)
AB	LC0811	1/2 in. (13 mm) - 10 ft (3.0 m)
AC	LC0812	1/2 in. (13 mm) - 15 ft (4.6 m)
AG	LC0813	3/4 in. (19 mm) - 10 ft (3.0 m)
AH	LC0814	3/4 in. (19 mm) - 15 ft (4.6 m)
B4	LC0881	Heated, 1/4 in. (6.5 mm) - 2.5 ft (0.6 m)
B5	LC0882	Heated, 1/4 in. (6.5 mm) - 10 ft (3.0 m)
B6	LC0883	Heated, 1/4 in. (6.5 mm) - 15 ft (4.6 m)
B7	LC0884	Heated, 3/8 in. (9.5 mm) - 2.5 ft (0.6 m)
B8	LC0885	Heated, 3/8 in. (9.5 mm) - 10 ft (3.0 m)
B9	LC0886	Heated, 3/8 in. (9.5 mm) - 15 ft (4.6 m)
BA	LC0887	Heated, 1/2 in. (13 mm) - 2.5 ft (0.6 m)
BB	LC0888	Heated, 1/2 in. (13 mm) - 10 ft (3.0 m)
BC	LC0889	Heated, 1/2 in. (13 mm) - 15 ft (4.6 m)
BG	LC0890	Heated, 3/4 in. (19 mm) - 10 ft (3.0 m)
BH	LC0891	Heated, 3/4 in. (19 mm) - 15 ft (4.6 m)
C1	LC0161	Recirculating, On-Board Tanks, 3/16 in. (4.8 mm) - 2.5 ft (0.6 m)
C2	LC0162	Recirculating, On-Board Tanks, 3/16 in. (4.8 mm) - 10 ft (3.0 m)
C3	LC0163	Recirculating, On-Board Tanks, 3/16 in. (4.8 mm) - 15 ft (4.6 m)

C4	LC0164	Recirculating, On-Board Tanks, 1/4 in. (6.5 mm) - 2.5 ft (0.6 m)
C5	LC0165	Recirculating, On-Board Tanks, 1/4 in. (6.5 mm) - 10 ft (3.0 m)
C6	LC0166	Recirculating, On-Board Tanks, 1/4 in. (6.5 mm) - 15 ft (4.6 m)
C7	LC0167	Recirculating, On-Board Tanks, 3/8 in. (9.5 mm) - 2.5 ft (0.6 m)
C8	LC0168	Recirculating, On-Board Tanks, 3/8 in. (9.5 mm) - 10 ft (3.0 m)
C9	LC0169	Recirculating, On-Board Tanks, 3/8 in. (9.5 mm) - 15 ft (4.6 m)
CA	LC0170	Recirculating, On-Board Tanks, 1/2 in. (13 mm) - 2.5 ft (0.6 m)
CB	LC0171	Recirculating, On-Board Tanks, 1/2 in. (13 mm) - 10 ft (3.0 m)
CC	LC0172	Recirculating, On-Board Tanks, 1/2 in. (13 mm) - 15 ft (4.6 m)
CD	LC0173	Recirculating, On-Board Tanks, 3/4 in. (19 mm) - 10 ft (3.0 m)
CE	LC0174	Recirculating, On-Board Tanks, 3/4 in. (19 mm) - 15 ft (4.6 m)
D1	LC0175	Recirculating, Off-Board Tanks, 3/16 in. (4.8 mm) - 2.5 ft (0.6 m)
D2	LC0176	Recirculating, Off-Board Tanks, 3/16 in. (4.8 mm) - 10 ft (3.0 m)
D3	LC0177	Recirculating, Off-Board Tanks, 3/16 in. (4.8 mm) - 15 ft (4.6 m)
D4	LC0178	Recirculating, Off-Board Tanks, 1/4 in. (6.5 mm) - 2.5 ft (0.6 m)
D5	LC0179	Recirculating, Off-Board Tanks, 1/4 in. (6.5 mm) - 10 ft (3.0 m)
D6	LC0180	Recirculating, Off-Board Tanks, 1/4 in. (6.5 mm) - 15 ft (4.6 m)
D7	LC0181	Recirculating, Off-Board Tanks, 3/8 in. (9.5 mm) - 2.5 ft (0.6 m)
D8	LC0182	Recirculating, Off-Board Tanks, 3/8 in. (9.5 mm) - 10 ft (3.0 m)
D9	LC0183	Recirculating, Off-Board Tanks, 3/8 in. (9.5 mm) - 15 ft (4.6 m)
DA	LC0184	Recirculating, Off-Board Tanks, 1/2 in. (13 mm) - 2.5 ft (0.6 m)
DB	LC0185	Recirculating, Off-Board Tanks, 1/2 in. (13 mm) - 10 ft (3.0 m)
DC	LC0186	Recirculating, Off-Board Tanks, 1/2 in. (13 mm) - 15 ft (4.6 m)
DD	LC0187	Recirculating, Off-Board Tanks, 3/4 in. (19 mm) - 10 ft (3.0 m)
DE	LC0188	Recirculating, Off-Board Tanks, 3/4 in. (19 mm) - 15 ft (4.6 m)
E1	LC0190	Recirculating, Heated, On-Board Tanks, 1/4 in. (6.5 mm) - 2.5 ft (0.6 m)
E2	LC0191	Recirculating, Heated, On-Board Tanks, 1/4 in. (6.5 mm) - 10 ft (3.0 m)

E3	LC0192	Recirculating, Heated, On-Board Tanks, 1/4 in. (6.5 mm) - 15 ft (4.6 m)
E4	LC0193	Recirculating, Heated, On-Board Tanks, 3/8 in. (9.5 mm) - 2.5 ft (0.6 m)
E5	LC0194	Recirculating, Heated, On-Board Tanks, 3/8 in. (9.5 mm) - 10 ft (3.0 m)
E6	LC0195	Recirculating, Heated, On-Board Tanks, 3/8 in. (9.5 mm) - 15 ft (4.6 m)
E7	LC0196	Recirculating, Heated, On-Board Tanks, 1/2 in. (13 mm) - 2.5 ft (0.6 m)
E8	LC0197	Recirculating, Heated, On-Board Tanks, 1/2 in. (13 mm) - 10 ft (3.0 m)
E9	LC0198	Recirculating, Heated, On-Board Tanks, 1/2 in. (13 mm) - 15 ft (4.6 m)
EA	LC0199	Recirculating, Heated, On-Board Tanks, 3/4 in. (19 mm) - 10 ft (3.0 m)
EB	LC0200	Recirculating, Heated, On-Board Tanks, 3/4 in. (19 mm) - 15 ft (4.6 m)
F1	LC0201	Recirculating, Heated, Off-Board Tanks, 1/4 in. (6.5 mm) - 2.5 ft (0.6 m)
F2	LC0202	Recirculating, Heated, Off-Board Tanks, 1/4 in. (6.5 mm) - 10 ft (3.0 m)
F3	LC0203	Recirculating, Heated, Off-Board Tanks, 1/4 in. (6.5 mm) - 15 ft (4.6 m)
F4	LC0204	Recirculating, Heated, Off-Board Tanks, 3/8 in. (9.5 mm) - 2.5 ft (0.6 m)
F5	LC0205	Recirculating, Heated, Off-Board Tanks, 3/8 in. (9.5 mm) - 10 ft (3.0 m)
F6	LC0206	Recirculating, Heated, Off-Board Tanks, 3/8 in. (9.5 mm) - 15 ft (4.6 m)
F7	LC0207	Recirculating, Heated, Off-Board Tanks, 1/2 in. (13 mm) - 2.5 ft (0.6 m)
F8	LC0208	Recirculating, Heated, Off-Board Tanks, 1/2 in. (13 mm) - 10 ft (3.0 m)
F9	LC0209	Recirculating, Heated, Off-Board Tanks, 1/2 in. (13 mm) - 15 ft (4.6 m)
FA	LC0210	Recirculating, Heated, Off-Board Tanks, 3/4 in. (19 mm) - 10 ft (3.0 m)
FB	LC0211	Recirculating, Heated, Off-Board Tanks, 3/4 in. (19 mm) - 15 ft (4.6 m)
GA	LC0400	High Pressure, 3/8 in. (9.5 mm) - 2.5 ft (0.6 m)
GB	LC0401	High Pressure, 3/8 in. (9.5 mm) - 10 ft (3.0 m)
GC	LC0402	High Pressure, 3/8 in. (9.5 mm) - 15 ft (4.6 m)
GD	LC0403	High Pressure, 1/2 in. (13 mm) - 2.5 ft (0.6 m)
GE	LC0404	High Pressure, 1/2 in. (13 mm) - 10 ft (3.0 m)
GF	LC0405	High Pressure, 1/2 in. (13 mm) - 15 ft (4.6 m)
GH	LC0406	High Pressure, 3/4 in. (19 mm) - 10 ft (3.0 m)

GJ	LC0407	High Pressure, 3/4 in. (19 mm) - 15 ft (4.6 m)
GK	LC0432	High Pressure, Recirculating, On-Board Tanks, 3/8 in. (9.5 mm) - 2.5 ft (0.6 m)
GL	LC0433	High Pressure, Recirculating, On-Board Tanks, 3/8 in. (9.5 mm) - 10 ft (3.0 m)
GM	LC0434	High Pressure, Recirculating, On-Board Tanks, 3/8 in. (9.5 mm) - 15 ft (4.6 m)
GQ	LC0435	High Pressure, Recirculating, On-Board Tanks, 1/2 in. (13 mm) - 2.5 ft (0.6 m)
GR	LC0436	High Pressure, Recirculating, On-Board Tanks, 1/2 in. (13 mm) - 10 ft (3.0 m)
GS	LC0437	High Pressure, Recirculating, On-Board Tanks, 1/2 in. (13 mm) - 15 ft (4.6 m)
GT	LC0438	High Pressure, Recirculating, On-Board Tanks, 3/4 in. (19 mm) - 10 ft (3.0 m)
GU	LC0439	High Pressure, Recirculating, On-Board Tanks, 3/4 in. (19 mm) - 15 ft (4.6 m)
GW	LC0440	High Pressure, Recirculating, On-Board Tanks, 3/8 in. (9.5 mm) - 2.5 ft (0.6 m)
GX	LC0441	High Pressure, Recirculating, On-Board Tanks, 3/8 in. (9.5 mm) - 10 ft (3.0 m)
GY	LC0442	High Pressure, Recirculating, On-Board Tanks, 3/8 in. (9.5 mm) - 15 ft (4.6 m)
G1	LC0443	High Pressure, Recirculating, On-Board Tanks, 1/2 in. (13 mm) - 2.5 ft (0.6 m)
G2	LC0444	High Pressure, Recirculating, On-Board Tanks, 1/2 in. (13 mm) - 10 ft (3.0 m)
G3	LC0445	High Pressure, Recirculating, On-Board Tanks, 1/2 in. (13 mm) - 15 ft (4.6 m)
G4	LC0446	High Pressure, Recirculating, On-Board Tanks, 3/4 in. (19 mm) - 10 ft (3.0 m)
G5	LC0447	High Pressure, Recirculating, On-Board Tanks, 3/4 in. (19 mm) - 15 ft (4.6 m)
HA	LC0472	High Pressure, Heated, 3/8 in. (9.5 mm) - 2.5 ft (0.6 m)
HB	LC0473	High Pressure, Heated, 3/8 in. (9.5 mm) - 10 ft (3.0 m)

Models

HC	LC0474	High Pressure, Heated, 3/8 in. (9.5 mm) - 15 ft (4.6 m)
HF	LC0475	High Pressure, Heated, 1/2 in. (13 mm) - 2.5 ft (0.6 m)
HG	LC0476	High Pressure, Heated, 1/2 in. (13 mm) - 10 ft (3.0 m)
HJ	LC0477	High Pressure, Heated, 1/2 in. (13 mm) - 15 ft (4.6 m)
HL	LC0478	High Pressure, Heated, 3/4 in. (19 mm) - 10 ft (3.0 m)
HM	LC0479	High Pressure, Heated, 3/4 in. (19 mm) - 15 ft (4.6 m)
HQ	LC0480	High Pressure, Heated, 3/8 in. (9.5 mm) - 2.5 ft (0.6 m)
HR	LC0481	High Pressure, Heated, 3/8 in. (9.5 mm) - 10 ft (3.0 m)
HS	LC0482	High Pressure, Heated, 3/8 in. (9.5 mm) - 15 ft (4.6 m)
HT	LC0483	High Pressure, Heated, 1/2 in. (13 mm) - 2.5 ft (0.6 m)
HU	LC0484	High Pressure, Heated, 1/2 in. (13 mm) - 10 ft (3.0 m)
HX	LC0485	High Pressure, Heated, 1/2 in. (13 mm) - 15 ft (4.6 m)
HY	LC0486	High Pressure, Heated, 3/4 in. (19 mm) - 10 ft (3.0 m)
H2	LC0487	High Pressure, Heated, 3/4 in. (19 mm) - 15 ft (4.6 m)
NN	---	Not required
Code K Part Dispense Valve		
N	N/A	None
2	255179	MD2, Valve Only with 1:1 Nose
3	255181	MD2, Valve Only with 10:1 Nose
4	LC0120	MD2, Handheld with 1:1 Nose
5	LC0122	MD2, Handheld with 10:1 Nose
6	LC0121	MD2, Lever with 1:1 Nose
7	LC0123	MD2, Lever with 10:1 Nose
Code L Part Mixer Type		
N	N/A	None
1	LC0063	3/16 in. (4.8 mm) x 32
2	LC0057	1/4 in. (6.4 mm) x 24
3	LC0058	3/8 in. (9.5 mm) x 24
4	LC0059	3/8 in. (9.5 mm) x 36
5	LC0060	3/8 in. (9.5 mm) Combo
6	LC0062	1/4 in. (6.4 mm) x 24 Luer Lock
7	LC0061	3/16 in. (4.8 mm) x 32 Luer Lock
8	LC0295	1/2 in. (12.7 mm) x 24
9	LC0296	1/2 in. (12.7 mm) x 36

Code M	Part	Applicator Mounting
N	LC0294	None, Customer Mount Controls and Applicator
1	LC0292	Mast Mount, Controls & MD2 Applicator Machine Mounted
2	LC0293	Mast Mount, Controls Only
3	256439	Tank Stand Mount, Controls & MD2 Applicator Machine Mounted
4	256438	Tank Stand Mount, Controls Only
Code N	Part	Power Cord Option
1	121055	120VAC North American Cord Set
2	121054	10A, 250V US Cord Set
3	121056	10A, 250V Continental Europe
4	121057	10A, 250V U.K./Ireland
5	121058	10A, 250V Israel
6	124864	10A, 250V Australia
7	124861	10A, 250V Italy
8	124863	10A, 250V Switzerland
9	124862	10A, 250V Denmark
A	121060	10A, 250V India
B	N/A	Heat Controller Option
Code O	Part	Flow Monitoring
N	LC0041	None
1	257433	Pressure Transducer
2	LC0302	Two 0.5 gpm Flow Meters, No Pressure Transducers
3	LC0305	Two 1.0 gpm Flow Meters, No Pressure Transducers
4	LC0303	One 1.0 gpm Flow Meter, One 0.5 gpm Flow Meter, No Pressure Transducers
5	LC0307	Two 2.0 gpm Flow Meters, No Pressure Transducers
6	LC0306	One 2.0 gpm Flow Meter, One 1.0 gpm Flow Meter, No Pressure Transducers
7	LC0304	One 2.0 gpm Flow Meter, One 0.5 gpm Flow Meter, No Pressure Transducers
A	LC0312	Two 0.5 gpm Flow Meters, With Pressure Transducers
B	LC0315	Two 1.0 gpm Flow Meters, With Pressure Transducers
C	LC0313	One 1.0 gpm Flow Meter, One 0.5 gpm Flow Meter, With Pressure Transducers
D	LC0317	Two 2.0 gpm Flow Meters, With Pressure Transducers
E	LC0316	One 2.0 gpm Flow Meter, One 1.0 gpm Flow Meter, With Pressure Transducers
F	LC0314	One 2.0 gpm Flow Meter, One 0.5 gpm Flow Meter, With Pressure Transducers

Code P	Part	High Volume Side Tank
N	N/A	None
1	256896	No Tanks, 1 1/2 in. npt flange
2	255241	8 L, Twin Polyethylene Tanks and Lids
3	255250	8 L, Twin Polyethylene Tanks and Lids, One 120V Agitator
4	255251	8 L, Twin Polyethylene Tanks and Lids, Two 120V Agitators
5	255281	8 L, Twin Polyethylene Tanks and Lids, with Shut-Off Valves
6	255282	8 L, Twin Polyethylene Tanks and Lids, One 120V Agitator, with Shut-Off Valves
7	255283	8 L, Twin Polyethylene Tanks and Lids, Two 120V Agitators, with Shut-Off Valves
8	LC0235★	7.5 L, Stainless Steel, High Level Sensors
9	LC0236★	7.5 L, Stainless Steel, High Level Sensors, with Shut-Off Valve
A	LC0013★	3 L, Stainless Steel
B	LC0012★	7.5 L, Stainless Steel
C	255285★	3 L, Stainless Steel, with Shut-Off Valve
D	LC0156	8 L, Twin Polyethylene Tanks and Lids, One Pneumatic Agitator
E	LC0157	8 L, Twin Polyethylene Tanks and Lids, Two Pneumatic Agitator
F	255284★	7.5 L, Stainless Steel, with Shut-Off Valve
G	LC0254★	7.5 L, Stainless Steel, 240V Heat
H	LC0255★	7.5 L, Stainless Steel, 240V Heat, with Shut-Off Valve
J	LC0054	30 L, Stainless Steel
K	LC0158	8 L, Twin Polyethylene Tanks and Lids, One Pneumatic Agitator, with Shut-Off Valves
L	LC0259	30 L, Stainless Steel, 240V Heat
M	LC0055	60 L, Stainless Steel
P	LC0159	8 L, Twin Polyethylene Tanks and Lids, Two Pneumatic Agitators, with Shut-Off Valves
R	LC0260	60 L, Stainless Steel, 240V Heat
S	LC0126	8 L, Twin Polyethylene Tanks and Lids, One 240V Agitator
T	LC0127	8 L, Twin Polyethylene Tanks and Lids, Two 240V Agitators
U	LC0128	8 L, Twin Polyethylene Tanks and Lids, One 240V Agitator, with Shut-Off Valves
V	LC0238★	7.5 L, Stainless Steel, High Level Sensors, 240V Heat, with Shut-Off Valve

W	LC0129	8 L, Twin Polyethylene Tanks and Lids, Two 240V Agitators, with Shut-Off Valves
X	LC0160	Accumulator, Fluoroelastomer
Y	LC0297	Accumulator, EP
Z	LC0237★	7.5 L, Stainless Steel, High Level Sensors, 240V Heat
---	★	When ordering tanks for spare or replacement parts, refer to Parts section of the PR70 and PR70v Feed Systems manual.
Code Q	Part	High Volume Side Tank Cover
N	N/A	None
1	LC0018	On-Board Dust Cover
2	LC0019	On-Board Clamp Down
3	LC0020	On-Board Vacuum De-gas
4	LC0021	On-Board Agitate 120VAC 50/60 Hz
5	LC0022	On-Board Agitate 240VAC 50/60 Hz
6	LC0023	On-Board Agitate 120 VAC 50/60 Hz and De-gas
7	LC0024	On-Board Agitate 240 VAC 50/60 Hz and De-gas
8	LC0025	On-Board 120VAC 50/60 Hz, De-gas and Fill-Port
9	LC0026	On-Board 240 VAC 50/60 Hz, De-gas and Fill-Port
A	LC0142	Off-Board Clamp Down - 30L
B	LC0101	Off-Board Clamp Down - 60L
C	LC0043	Off-Board Vacuum De-gas - 30L
F	LC0102	Off-Board Vacuum De-gas - 60L
G	LC0047	Off-Board Electric Agitator - 30L
H	LC0048	Off-Board Electric Agitator - 60L
K	LC0147	Off-Board Vacuum De-gas, Pneumatic Agitator, Fill Port, Slinger - 60 L
M	LC0051	Off-Board Vacuum De-gas, Electric Agitator, Fill Port, Slinger - 30 L
R	LC0052	Off-Board Vacuum De-gas, Electric Agitator, Fill Port, Slinger - 60 L
S	LC0130	On-Board, Pneumatic Agitate
T	LC0131	On-Board, Pneumatic Agitate, De-gas
U	LC0132	On-Board, Pneumatic Agitate, De-gas, Fill Port
V	LC0142	Off-Board Pneumatic Agitator - 30 L
W	LC0143	Off-Board Pneumatic Agitator - 60 L
Z	LC0146	Off-Board Vacuum De-gas, Pneumatic Agitator, Fill Port, Slinger - 30 L
Code R	Part	Low Volume Side Tank
N	N/A	None
1	256896	No Tanks, 1 1/2 in. npt flange
8	LC0235★	7.5 L, Stainless Steel, High Level Sensors

Models

9	LC0236★	7.5 L, Stainless Steel, High Level Sensors, with Shut-Off Valve
A	LC0013★	3 L, Stainless Steel
B	LC0012★	7.5 L, Stainless Steel
C	255285★	3 L, Stainless Steel, with Shut-Off Valve
F	255284★	7.5 L, Stainless Steel, with Shut-Off Valve
G	LC0254★	7.5 L, Stainless Steel, 240V Heat
H	LC0255★	7.5 L, Stainless Steel, 240V Heat, with Shut-Off Valve
J	LC0054	30 L, Stainless Steel
L	LC0259	30 L, Stainless Steel, 240V Heat
M	LC0055	60 L, Stainless Steel
R	LC0260	60 L, Stainless Steel, 240V Heat
V	LC0238★	7.5 L, Stainless Steel, High Level Sensors, 240V Heat, with Shut-Off Valve
X	LC0160	Accumulator, Fluoroelastomer
Y	LC0297	Accumulator, EP
Z	LC0237★	7.5 L, Stainless Steel, High Level Sensors, 240V Heat
---	★	When ordering tanks for spare or replacement parts, refer to Parts section of the PR70 and PR70v Feed Systems manual.
Code S	Part	Low Volume Side Tank Covers
N	N/A	None
1	LC0018	On-Board Dust Cover
2	LC0019	On-Board Clamp Down
3	LC0020	On-Board Vacuum De-gas
4	LC0021	On-Board Agitate 120VAC 50/60 Hz
5	LC0022	On-Board Agitate 240VAC 50/60 Hz
6	LC0023	On-Board Agitate 120 VAC 50/60 Hz and De-gas
7	LC0024	On-Board Agitate 240 VAC 50/60 Hz and De-gas
8	LC0025	On-Board 120VAC 50/60 Hz, De-gas and Fill-Port
9	LC0026	On-Board 240 VAC 50/60 Hz, De-gas and Fill-Port
A	LC0142	Off-Board Clamp Down - 30L
B	LC0101	Off-Board Clamp Down - 60L
C	LC0043	Off-Board Vacuum De-gas - 30L
F	LC0102	Off-Board Vacuum De-gas - 60L
G	LC0047	Off-Board Electric Agitator - 30L
H	LC0048	Off-Board Electric Agitator - 60L
K	LC0147	Off-Board Vacuum De-gas, Pneumatic Agitator, Fill Port, Slinger - 60 L

M	LC0051	Off-Board Vacuum De-gas, Electric Agitator, Fill Port, Slinger - 30 L
R	LC0052	Off-Board Vacuum De-gas, Electric Agitator, Fill Port, Slinger - 60 L
S	LC0130	On-Board, Pneumatic Agitate
T	LC0131	On-Board, Pneumatic Agitate, De-gas
U	LC0132	On-Board, Pneumatic Agitate, De-gas, Fill Port
V	LC0142	Off-Board Pneumatic Agitator - 30 L
W	LC0143	Off-Board Pneumatic Agitator - 60 L
Z	LC0146	Off-Board Vacuum De-gas, Pneumatic Agitator, Fill Port, Slinger - 30 L
Code T	Part	Tank Level Sensors
N	N/A	None
2	LC0278	Polyethylene Tanks - Low Level Sensors Only
3	LC0279	Two 7.5 L Stainless Steel Tanks - Low Level Sensors Only
4	LC0282	Two 30 L or 60 L Stainless Steel Tanks - Low Level Sensors Only
5	LC0281	7.5 L Stainless Steel - Low Level Sensors Only, and 30 L or 60 L Stainless Steel - Low Level Sensors Only
6	LC0280	Accumulator Sensors, and 7.5 L Low Level Sensors
7	LC0283	Accumulator Sensors, and 30 L or 60 L Low Level Sensors
9	LC0284	Two 7.5 L Stainless Steel Tanks - High and Low Level Sensors with Refill Logic
A	LC0287	Two 30 L or 60 L Stainless Steel Tanks - High and Low Level Sensors with Refill Logic
B	LC0286	7.5 L Stainless Steel - Low Level Sensors, and 30 L or 60 L Stainless Steel - High and Low Level Sensors with Refill Logic
C	LC0289	7.5 L Stainless Steel - High and Low Level Sensors with Refill Logic, and 30 L or 60 L Stainless Steel - High and Low Level Sensors with Refill Logic
D	LC0285	Accumulator Sensors, and 7.5 L High and Low Level Sensors
E	LC0288	Accumulator Sensors, and 30 L or 60 L High and Low Level Sensors
G	N/A	Two Sets of Accumulator Sensors

Code U	Part	Heat Zone Controller
N	N/A	None
C	LC0250	1 Tank or 1 Hose
D	LC0251	2 Tanks, 1 Tank and 1 Hose, or 2 Hoses
E	LC0252	2 Tanks and 1 Hose, or 1 Tank and 2 Hoses
F	LC0253	2 Tanks and 2 Hoses
Code V	Part	Off-Board Tank Stands
N	N/A	None
2	LC0103	PR70 Tank Stand
3	LC0247	PR70v Tank Stand

Hydracheck Option











The Hydracheck option regulates the speed or feed rate of the pump. It is recommended that the Hydracheck option is installed when using the flow control function. Flow control performs best if the majority of the pump restriction is external to the material flow (such as from the Hydracheck adjustment) or is from a restriction in the material path prior to the mixing point. See FIG. 3 on page 16 for the location of the Hydracheck on the PR70f.

Product Pump Selection







When selecting the pumps for the fixed ratio PR70f, you need to know the material ratio, expected dispense flow rate, and minimum programmed dispense amount. See **Appendix C - Product Pump Selection Guide** on page 93 for information that will help with selecting pump sizes.

Warnings

The following warnings are for the setup, use, grounding, maintenance, and repair of this equipment. The exclamation point symbol alerts you to a general warning and the hazard symbols refer to procedure-specific risks. When these symbols appear in the body of this manual or on warning labels, refer back to these Warnings. Product-specific hazard symbols and warnings not covered in this section may appear throughout the body of this manual where applicable.

 <h1 style="margin: 0;">WARNING</h1>	
    	<p>SKIN INJECTION HAZARD</p> <p>High-pressure fluid from dispensing device, hose leaks, or ruptured components will pierce skin. This may look like just a cut, but it is a serious injury that can result in amputation. Get immediate surgical treatment.</p> <ul style="list-style-type: none"> Do not point the dispensing device at anyone or at any part of the body. Do not put your hand over the fluid outlet. Do not stop or deflect leaks with your hand, body, glove, or rag. Follow the Pressure Relief Procedure when you stop dispensing and before cleaning, checking, or servicing equipment. Tighten all fluid connections before operating the equipment. Check hoses and couplings daily. Replace worn or damaged parts immediately.
 	<p>MOVING PARTS HAZARD</p> <p>Moving parts can pinch, cut or amputate fingers and other body parts.</p> <ul style="list-style-type: none"> Keep clear of moving parts. Do not operate equipment with protective guards or covers removed. Pressurized equipment can start without warning. Before checking, moving, or servicing equipment, follow the Pressure Relief Procedure and disconnect all power sources.
 	<p>TOXIC FLUID OR FUMES HAZARD</p> <p>Toxic fluids or fumes can cause serious injury or death if splashed in the eyes or on skin, inhaled, or swallowed.</p> <ul style="list-style-type: none"> Read Safety Data Sheet (SDS) to know the specific hazards of the fluids you are using. Route exhaust away from work area. If diaphragm ruptures, fluid may be exhausted into the air. Store hazardous fluid in approved containers, and dispose of it according to applicable guidelines.

⚠️ WARNING

 	<p>ELECTRIC SHOCK HAZARD</p> <p>This equipment must be grounded. Improper grounding, setup, or usage of the system can cause electric shock.</p> <ul style="list-style-type: none"> • Turn off and disconnect power cord before servicing equipment. • Connect only to grounded electrical outlets. • Use only 3-wire extension cords. • Ensure ground prongs are intact on power and extension cords. • Do not expose to rain. Store indoors.
   	<p>FIRE AND EXPLOSION HAZARD</p> <p>Flammable fumes, such as solvent and paint fumes, in work area can ignite or explode. Paint or solvent flowing through the equipment can cause static sparking. To help prevent fire and explosion:</p> <ul style="list-style-type: none"> • Use equipment only in well ventilated area. • Eliminate all ignition sources; such as pilot lights, cigarettes, portable electric lamps, and plastic drop cloths (potential static sparking). • Ground all equipment in the work area. See Grounding instructions. • Never spray or flush solvent at high pressure. • Keep work area free of debris, including solvent, rags and gasoline. • Do not plug or unplug power cords, or turn power or light switches on or off when flammable fumes are present. • Use only grounded hoses. • Hold gun firmly to side of grounded pail when triggering into pail. Do not use pail liners unless they are anti-static or conductive. • Stop operation immediately if static sparking occurs or you feel a shock. Do not use equipment until you identify and correct the problem. • Keep a working fire extinguisher in the work area.
	<p>BURN HAZARD</p> <p>Equipment surfaces and fluid that is heated can become very hot during operation. To avoid severe burns:</p> <ul style="list-style-type: none"> • Do not touch hot fluid or equipment.

⚠️ WARNING



EQUIPMENT MISUSE HAZARD

Misuse can cause death or serious injury.

- Do not operate the unit when fatigued or under the influence of drugs or alcohol.
- Do not exceed the maximum working pressure or temperature rating of the lowest rated system component. See **Technical Data** in all equipment manuals.
- Use fluids and solvents that are compatible with equipment wetted parts. See **Technical Data** in all equipment manuals. Read fluid and solvent manufacturer's warnings. For complete information about your material, request Safety Data Sheet (SDS) from distributor or retailer.
- Do not leave the work area while equipment is energized or under pressure.
- Turn off all equipment and follow the **Pressure Relief Procedure** when equipment is not in use.
- Check equipment daily. Repair or replace worn or damaged parts immediately with genuine manufacturer's replacement parts only.
- Do not alter or modify equipment. Alterations or modifications may void agency approvals and create safety hazards.
- Make sure all equipment is rated and approved for the environment in which you are using it.
- Use equipment only for its intended purpose. Call your distributor for information.
- Route hoses and cables away from traffic areas, sharp edges, moving parts, and hot surfaces.
- Do not kink or over bend hoses or use hoses to pull equipment.
- Keep children and animals away from work area.
- Comply with all applicable safety regulations.



PERSONAL PROTECTIVE EQUIPMENT

Wear appropriate protective equipment when in the work area to help prevent serious injury, including eye injury, hearing loss, inhalation of toxic fumes, and burns. Protective equipment includes but is not limited to:

- Protective eyewear, and hearing protection.
- Respirators, protective clothing, and gloves as recommended by the fluid and solvent manufacturer.

Component Identification

This section provides a guide for identifying system components. Contact your Graco distributor or Graco Ohio Customer Service for assistance in designing a system to suit your particular needs.

Accessories are available from Graco. Make certain all accessories are adequately sized and pressure-rated for your system.

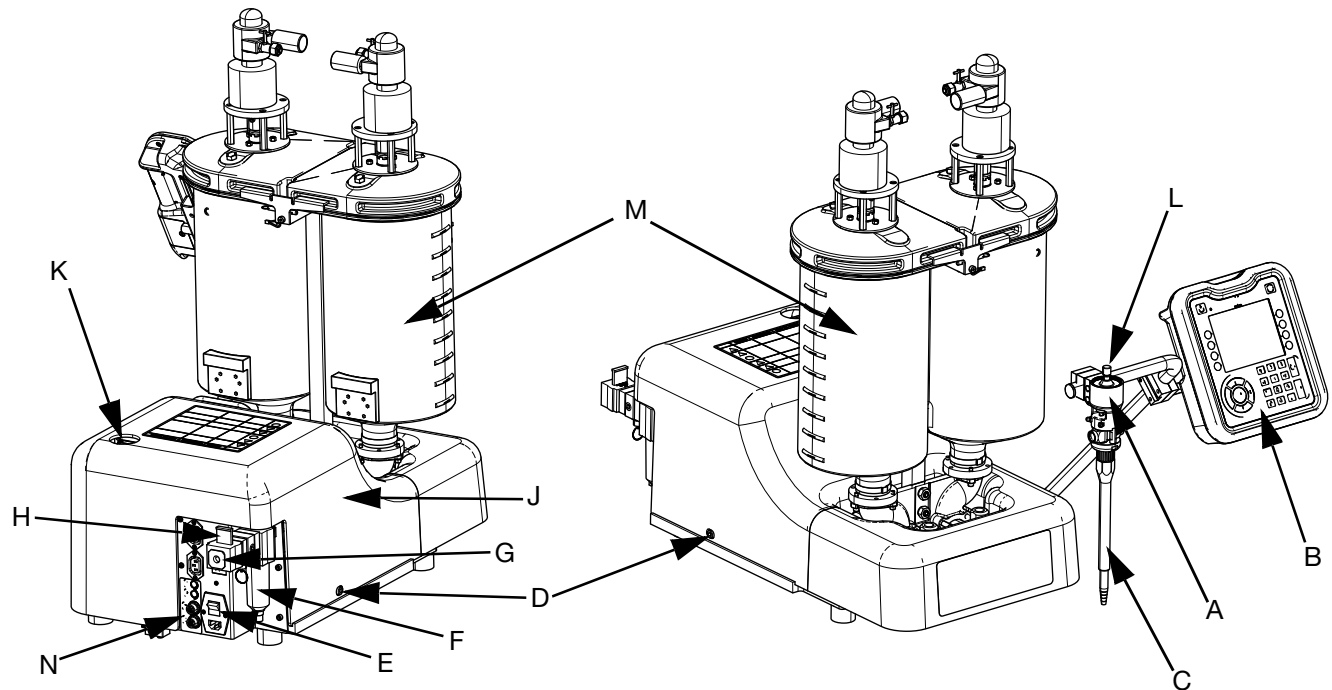

FIG. 1: Typical Fixed Ratio PR70f (Without Hoses)

Key:

- A Dispense Valve
- B Advanced Display Module (ADM)
- C Static Mixer
- D Shield Locking Screw
- E Power Switch
- F Air Filter
- G Air Inlet
- H Air Pressure Relief Switch
- J Protective Shield
- K Voltage-to-Pressure Regulator
- L Snuff Back Adjustment Knob
- M A and B Tanks (On-board polyethylene version shown)
- N External Control Interface Connections

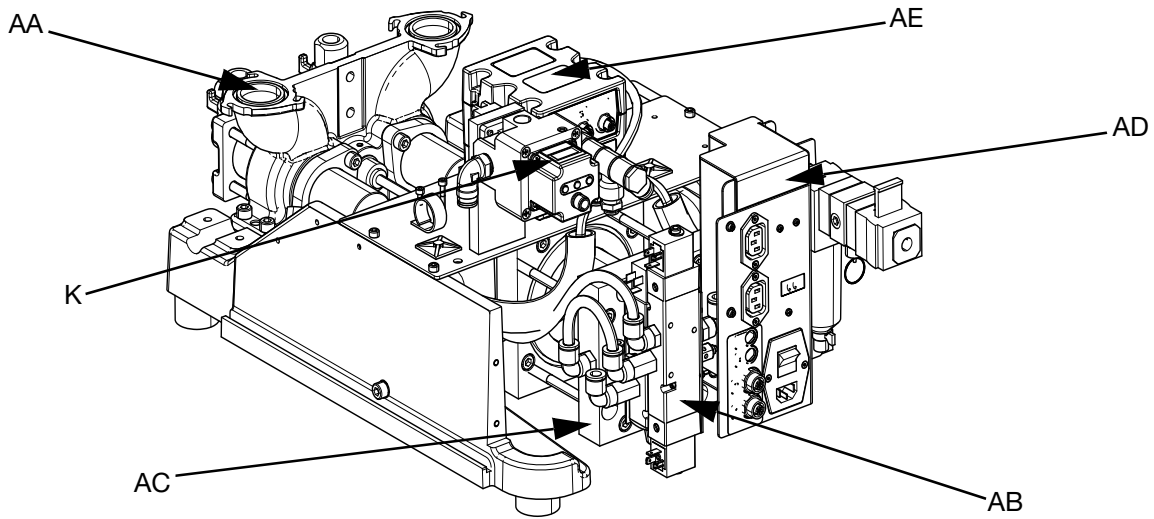

FIG. 2: PR70f Rear View with Shield, Tanks, Dispense Valve, and ADM Removed

Key:

- | | |
|--------------------------------|-------------------------------|
| AA Pump Assembly | AD DC Power Supply |
| AB Solenoid Valves | AE Fluid Control Module (FCM) |
| AC Air Cylinder/Motor Assembly | |

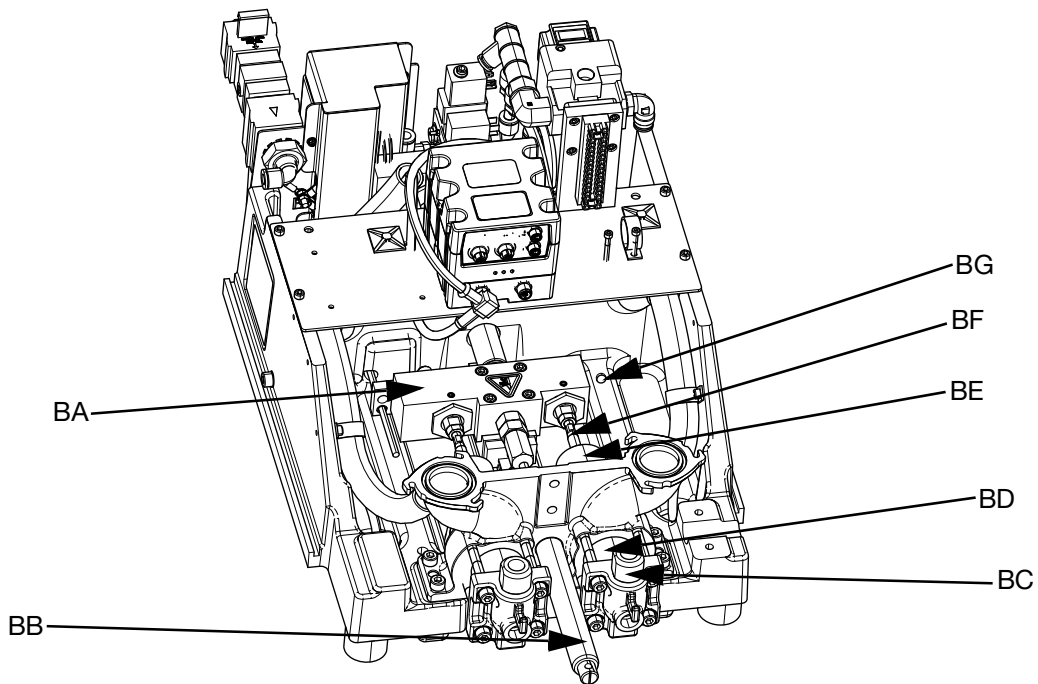

FIG. 3: PR70f Front View with Shield, Tanks, Dispense Valve, and ADM Removed

Key:

- | | |
|---|---------------------------------------|
| BA Drive Block | BE Rear Bearing |
| BB Hydracheck (Required for flow control feature) | BF Phase Adjustment Screw/Locking Nut |
| BC Check Valve | BG Mounting Hole in Base Frame |
| BD Metering Tube | |

Advanced Display Module (ADM)

The PR70f flow control option is only available on the ADM.

NOTE: If an invalid key is pressed, the ADM emits three quick beeps as notification.

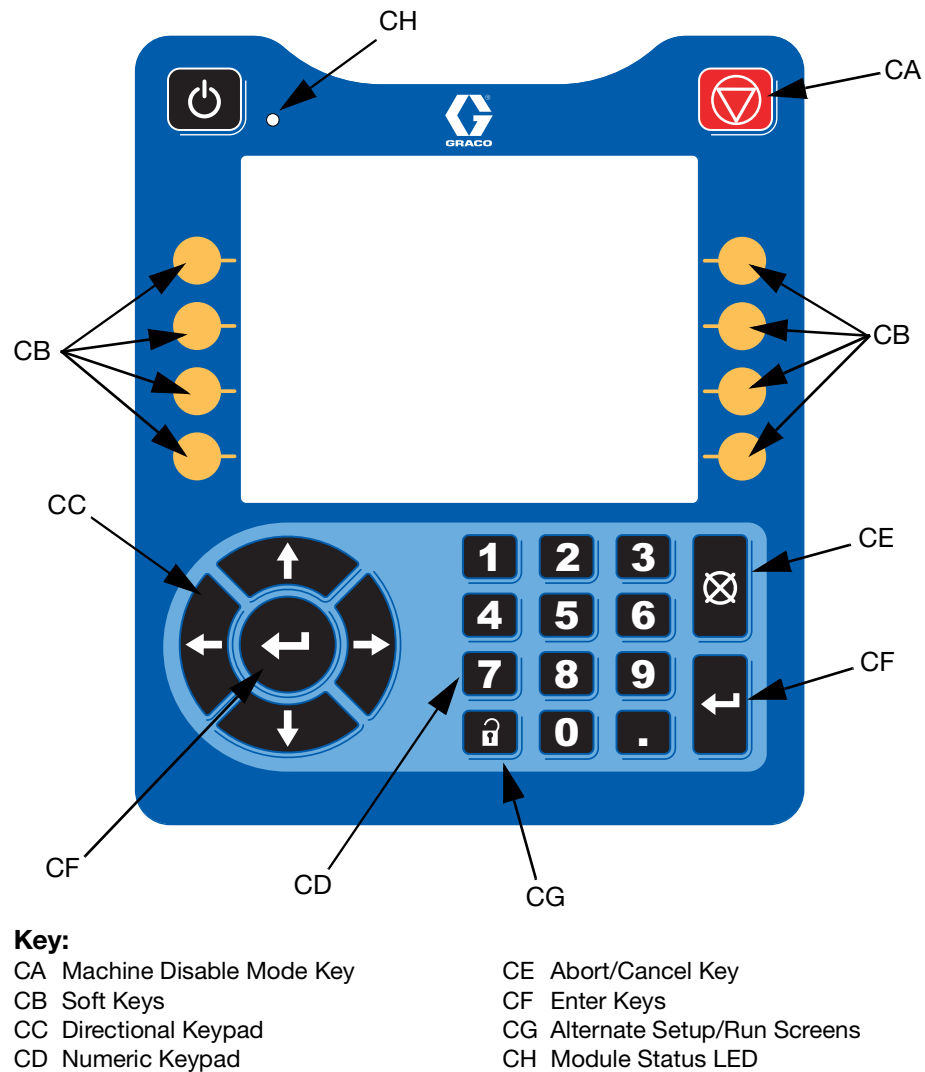





FIG. 4: ADM Component Identification

Module Status LED Diagnostics

State	Description
Solid Green	System enabled, valid mode selected
Flashing Yellow	System disabled (Setup screens)
Solid Yellow	System disabled (Run screens)





Grounding

				
<p>The equipment must be grounded to reduce the risk of static sparking and electric shock. Electric or static sparking can cause fumes to ignite or explode. Improper grounding can cause electric shock. Grounding provides an escape wire for the electric current.</p>				

This product must be grounded. In the event of an electrical short circuit, grounding reduces the risk of electric shock by providing an escape wire for the electric current. This product is equipped with a cord having a grounding wire with an appropriate grounding plug. The plug must be plugged into an outlet that is properly installed and grounded in accordance with all local codes and ordinances.

Improper installation of the grounding plug may result in electric shock. When repair or replacement of the cord or plug is required, do not connect the grounding wire to either flat blade terminal. The wire with insulation having an outer surface that is green with or without yellow stripes is the grounding wire. Do not modify the plug provided; if it does not fit the outlet, have the proper outlet installed by a qualified electrician. Only connect the product to an outlet having the same configuration as the plug. Do not use an adapter with this product.

Installation

				
<p>Avoid contact with electrical inter-connects when connecting electric power to the machine. Avoid contact with Krytox™ on the pump shaft, PE tank lid, and PE tank lid gasket. Contact with Krytox causes flu-like symptoms. Read all manufacturer's warning and material SDS to know the specific hazards of the material used.</p>				

Unpacking

Inspect the shipping container carefully for damage. Open the box and inspect the contents. There should not be any loose or damaged parts in the container. Contact the carrier promptly if there is damage.

Compare the packing slip against all the items in the box. Report any shortage or other inspection problems immediately.

Remove the PR70f system components from the container.

NOTICE
<p>Do not lift the PR70f by the tanks as this may result in damage to the machine.</p>

Locate and Mount the PR70f

1. Locate a bench top or open floor area to mechanically mount the PR70f. Ensure that the location has access to compressed air and AC power and is well ventilated.
2. Place the machine at the designated location. Allow the machine to rest on the rubber feet provided.
3. Turn the shield locking screws clockwise on both sides to remove the PR70f protective shield.
4. Attach the PR70f frame to the selected location by installing fasteners (not provided with the unit) through the four mounting holes. Refer to FIG. 5 below.

Variable Ratio

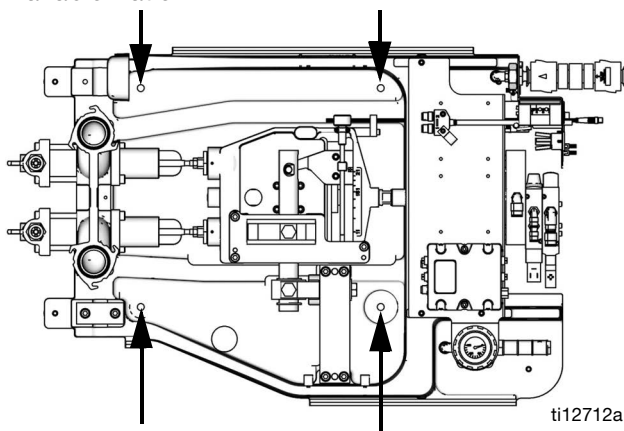

Fixed Ratio

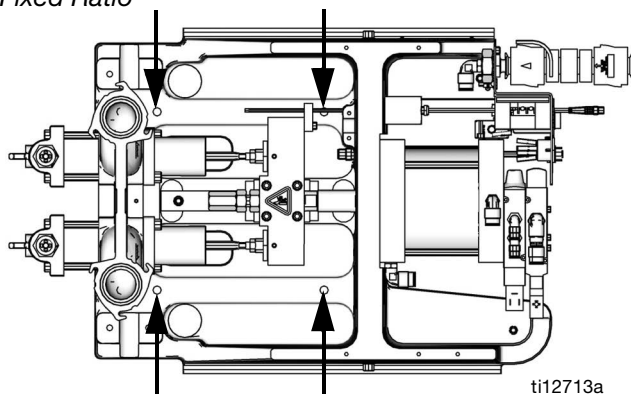

FIG. 5: Mounting Holes

Make Connections

All electrical wiring must be done by a qualified electrician and comply with all local codes and regulations.				

1. Connect a compressed air line to the air inlet at the back of the machine. Refer to FIG. 1 on page 15 for the location of the air inlet.
2. Using the power cord provided, connect AC power (100-240V, 50/60 HZ, single phase) to the machine.

Flush the System

The PR70f is tested at the factory with mineral oil. Flush the machine before first use.

NOTE: Do not load material into the tanks until the system has been flushed.

Startup



1. Locate the power switch at the rear of the machine and turn the power on. Refer to FIG. 1 on page 15. The display module will automatically turn on and begin to load.
2. With the air line connected to the machine, slide up the system air pressure relief switch (see FIG. 1). It is the yellow tab on the air inlet at the rear of the machine. The hole in the tab should not be showing.

Using the Advanced Display Module



NOTICE

To prevent damage to soft key buttons, do not press the buttons with sharp objects such as pens, plastic cards, or fingernails.

When the main electrical power is turned on, the Graco splash screen will be displayed on the ADM until communication and initialization is complete.



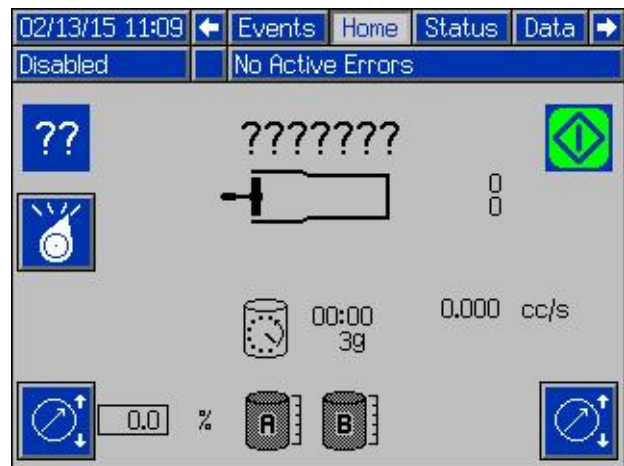

The ADM will operate in any mode other than Disabled

(shown below). Press the Mode Select soft key  to change to another operating mode. Once you have selected the desired mode, press the ADM's Enter key  to accept it.



There are two types of screens on the ADM: Run and Setup screens. The ADM starts in the Run screens. To

access the Setup screens, press . If the password feature is enabled, you need to enter the password when prompted to access the Setup screens. Use the numeric keypad to enter the password, then press .

Refer to the FIG. 6 on page 21 for an illustration of the available screens.

ADM Screen Navigation Diagram

The black arrows in the diagram below denote which arrow on the directional keypad to press to move to the respective screen.

Refer to FIG. 4, ADM Component Identification on page 17 for the location of the directional keypad arrows and the other keys on the ADM.

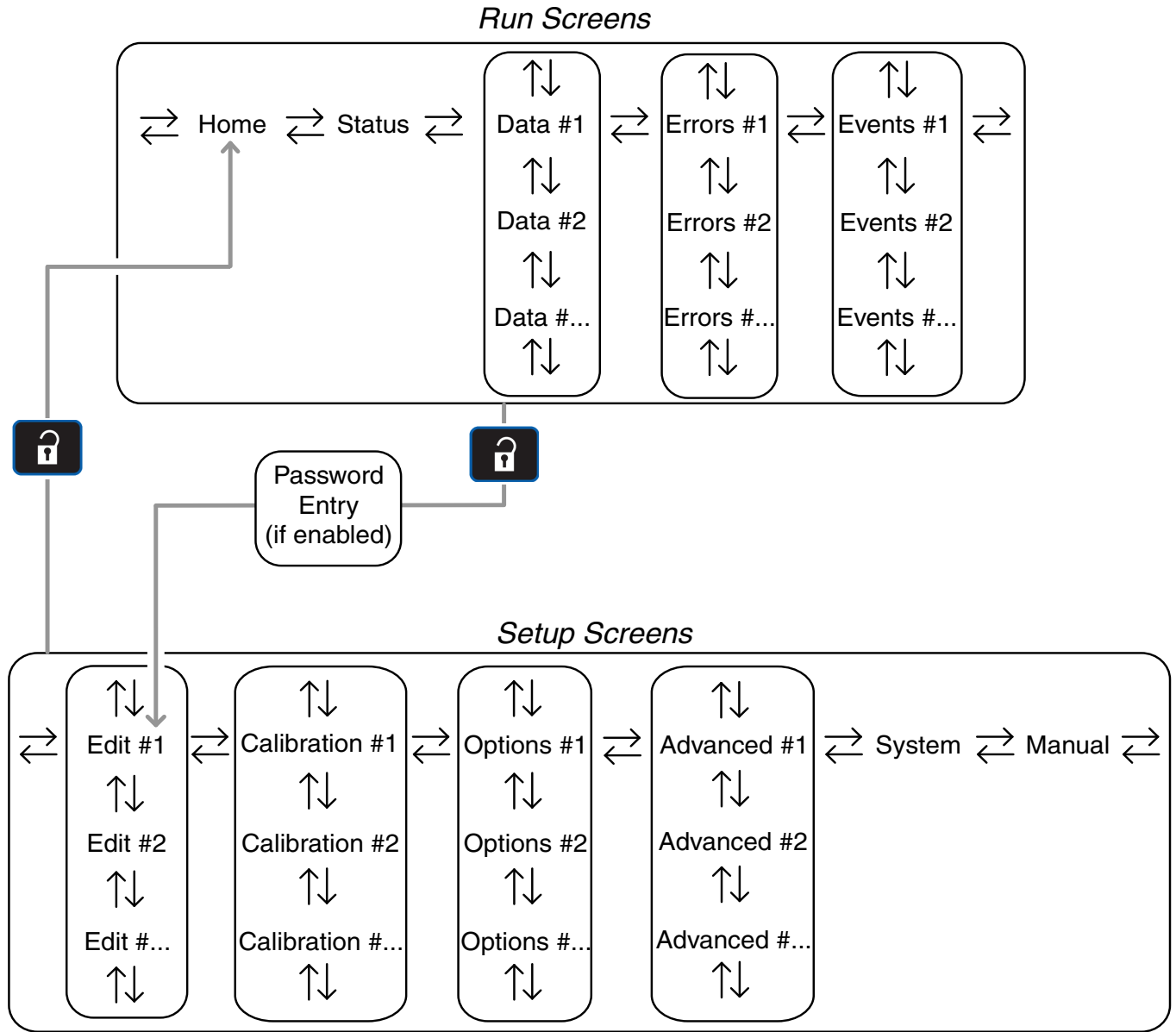

FIG. 6: ADM Screen Navigation

ADM Run Home Screen

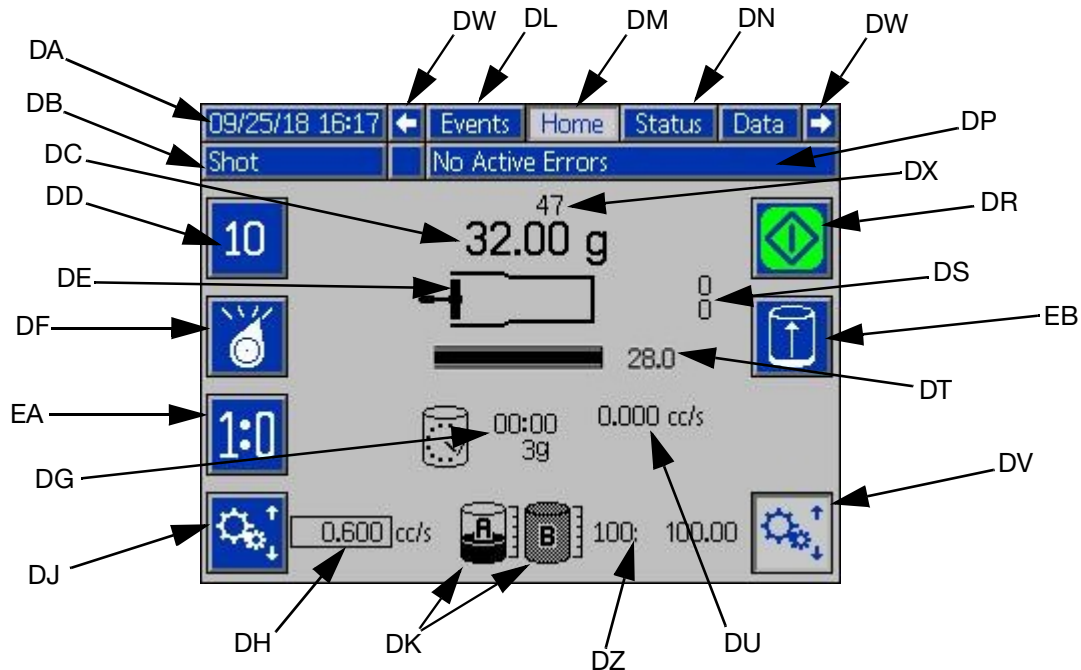



FIG. 7: Home Screen Legend

Key:

DA	Current Date and Time	DM	Selected (Active) Run Screen
DB	Selected Operating Mode	DN	Run Screens To Right
DC	Selected Shot Amount	DP	Active Error Indication Field
DD	Selected Shot Number	DR	Dispense Start/Stop
DE	Pump State	DS	Current A & B Pump Pressures (Pressure Illustrated are in Bar)
DF	Operating Mode Select	DT	Dispense Duration (in Seconds) Completion Status Bar
DG	Dwell Timer Shot Amount, Countdown Field	DU	Current Dispense Flow Rate
DH	Selected Dispense Rate (g/s, cc/s, %)	DV	Constant Flow/Torque Selection
DJ	Dispense Rate/Torque Percentage	DW	Navigate Left/Right Enabled Indicators
DK	A and B Tank Fill Statuses	DX	Shot Counter for Selected Shot
DL	Run Screen to Left	DY	Pump Auto/Manual Load Control and Indication
		DZ	Ratio Set Point (XX:1 Format in Figure)
		EA	Start/End Base Purge Operation
		EB	Start/End Tank Fill Operation

Home Screen Features

NOTE: Icons (such as ) on the ADM screens represent selections to enter settings, perform operations, and access screens. The ADM display is not a touch screen. You must press one of the soft keys next to the icon to perform its function. **In this manual, the terms “key” and “soft key” are interchangeable.**

Change the Operating Mode



The available operating modes at the Home screen are:

- Shot
- Sequence
- Operator (Manual)
- Recirculation
- Disabled

The operating mode is shown on the ADM screen under the date and time. See FIG. 7 on page 22.



To change modes of operation, press the  key repeatedly until the desired mode is displayed. Press



 to accept it or press  to keep the current mode.

NOTE: You can also use the up or down arrow keys (, ) on the directional keypad to scroll through the operation modes.

Change the Shot Number

Select the Shot or Sequence mode. Press the key next to the shot number  icon.



Use the up or down arrow keys (, ) on the directional keypad to select the desired shot number or enter the number using the numeric keypad.



Press  to accept it or press  to keep the current shot number.

NOTE: If an undefined shot number is entered (such as 0), the ADM beeps three times indicating an invalid entry.

Change the Shot Amount (Shot/Sequence Modes)



Select the Shot or Sequence mode. Press and hold the key next to the  icon for four seconds. Arrows are displayed next to the Selected Shot Amount field, indicating that the value can be changed.

Use the up or down arrow keys (, ) on the directional keypad to change the shot amount or enter the number using the numeric keypad.

Press  to accept it or press  to keep the current shot amount.

Select Constant Torque or Flow



Constant torque mode applies constant pressure to the air motor. Constant flow mode maintains a constant flow rate regardless of air pressure changes. To configure the machine to constant torque, press the key corresponding to the icon in the lower right corner of the

Home screen until the  icon shows. To configure the machine to constant flow, press the same key until the  icon shows.



Change the Torque Percentage/Dispense Rate

The icon for the key in the lower left corner of the screen changes depending on whether the machine is in constant torque or constant flow mode.



When the machine is in constant torque mode, the torque percentage icon  is showing. Press the key and use the numeric keypad to enter a new percentage in the field next to the icon when it becomes highlighted.



Press  to accept it or press  to keep the current value.

When the machine is in constant flow mode, the dispense rate icon  is showing. Press the key and use the numeric keypad to enter the desired flow rate in the field next to the icon when it becomes highlighted.

Press  to accept it or press  to keep the current value.

Start and Stop a Dispense



To start a dispense, press the  key when the PR70f is idle and not dispensing. The icon will change to  during the dispense.

To stop an active dispense, press the  key during an active dispense or press  on the keypad.



NOTE: A dispense also can be started and stopped using a foot switch or by activating a dry contact closure between pins 1 and 3 on connector #1 of the machine interface. Refer to **External Control Interface Setup** on page 67 for information about the dry contact closure.

Setup

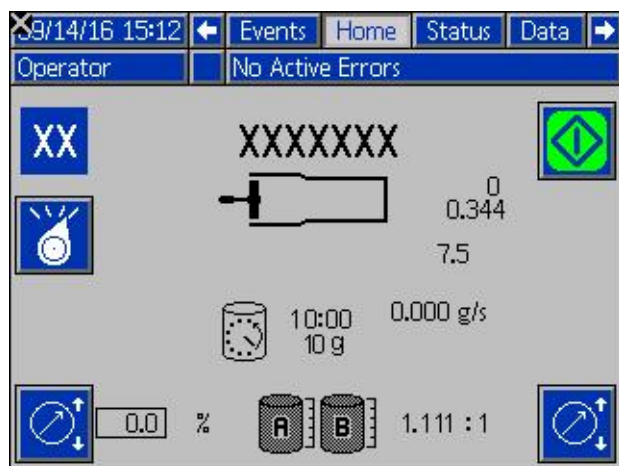

1. With the ADM at the main Run screen, select Operator mode by pressing the  key repeatedly, until the Operator option is displayed. Press  to accept it.



2. The PR70f should be in constant torque mode. In the bottom right corner of the display, verify that the constant torque icon  is displayed rather than the constant flow icon .

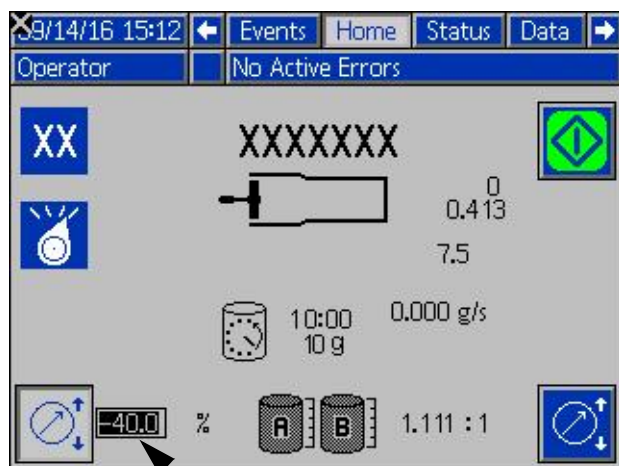

Step 3

3. Press the key for the torque percentage located in the lower left part of the screen. Enter a percentage in the highlighted field that is near the mid-range value for the air motor to achieve a mean line pressure. For example, if the line air is approximately 95 PSI (6 Bar), you can start with 40-45% and then adjust it up or down until a mean line pressure is achieved that provides the correct flow rate.
4. Press  to accept the percentage value. After selection, the display on the voltage-to-pressure regulator reflects the new entry. See FIG. 1 on page 15 for the location of the regulator.

Pump Position Calibration

The pump position calibration procedure may need to be repeated if the machine is being re-built, or when the linear position sensor, piston, or any electronic component is replaced.

The pump position calibration procedure teaches the machine the location of the most extended piston position, the most retracted piston position, and the position where the piston engages the pump cylinder.

The position sensor assigns a numeric value to the location of the piston. Higher numbers indicate the piston is more extended and lower numbers indicate the piston is more retracted.



NOTE: This procedure is best performed with any optional Hydracheck assembly removed from the machine.

Prepare the Machine for Calibration

1. Ensure that both piston shafts are screwed all the way into the drive block.
2. Ensure that there is a sufficient amount of material in the tanks.
3. Place a waste container under the dispense valve to capture any dispensed material.
4. Ensure the system air pressure relief switch is in the up position and the system air pressure regulator shows air pressure in the system.



Extended Piston Position

1. With the machine in Operator mode and set to constant torque, and with a mid-range setpoint percentage entered, press  to access Setup mode. Use the directional keypad to navigate to the Calibration screens.

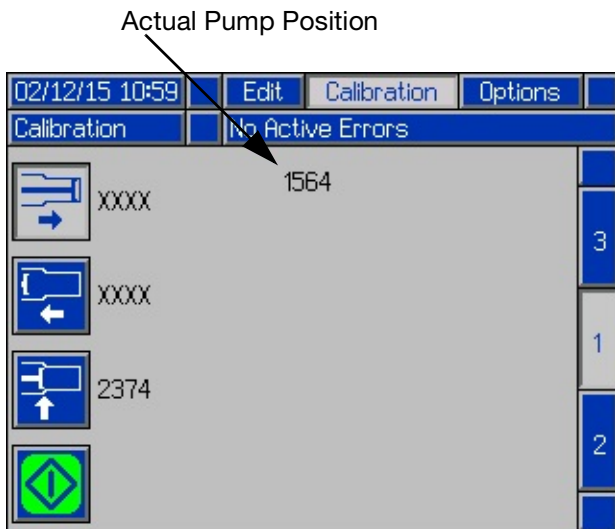
2. At Calibration screen 1, press the  key to set the piston to a fully extended position. The dispense icon  starts flashing and the actual position of the pump is displayed in the top center of the screen.









3. Press the  key or activate the machine's foot switch.

4. When the piston has reached its maximum extended position, press  to accept the new value or press  to keep the previous value. When accepted, the value appears next to the piston extended icon  at the calibration screen.





Retracted Piston Position

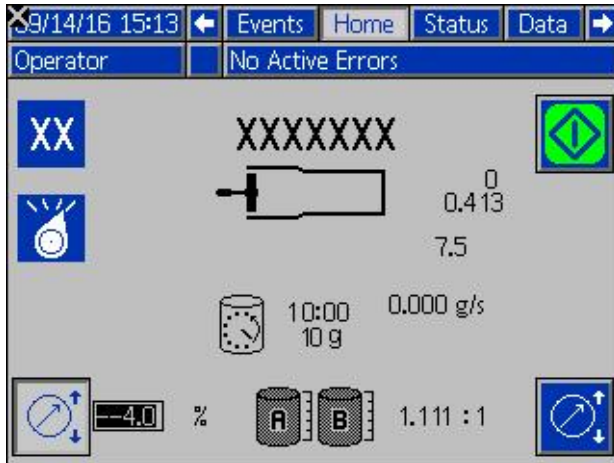

1. Press the  key to set the piston to a fully retracted position. The dispense icon  starts flashing and the actual position of the pump is displayed in the top center of the screen.
2. Press the  key or activate the machine's foot switch.
3. When the piston has reached its minimum position, press  to accept the new value or press  to keep the previous value. When accepted, the value appears next to the piston extended icon  at the calibration screen.

Metering Tube Position

Before calibrating the metering tube position, navigate to the ADM's Home screen and enter a very small constant torque percentage (1-4%).





1. Press  to access Setup mode. Use the directional keypad to navigate to the Calibration screens.

7. Press  to accept the new value or press  to keep the previous value. When accepted, the value appears next to the metering tube icon at the calibration screen, as shown below.

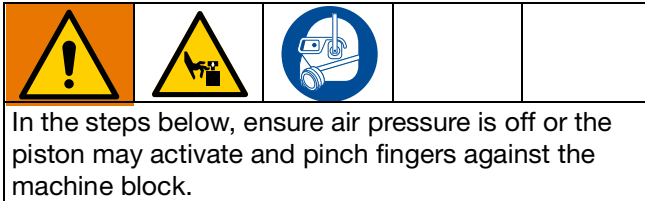

8. Press  to return to the ADM's Home screen. Reset the constant torque percentage to the original percentage value.



2. Relieve pressure by pressing down the system air pressure relief switch. See FIG. 1 on page 15 for the location of the air pressure relief switch.
3. Remove the machine cover.
4. At screen 1, press the  key.
5. Press the  key or activate the machine's foot switch.
6. After the machine instructs the piston to extend, manually pull on the machine drive block until resistance is felt where the pistons are entering the metering tubes. See FIG. 3 on page 16.

Pump Size, SG, and Flow Mode

To enable the PR70f logic to properly calculate values such as the flow rate, reversing position, and material counter information, you need to enter the pump size, SG and flow rate options.

1. Press  to access Setup mode. Use the directional keypad to navigate to Advanced screen 2. Then, use the keypad to navigate to the appropriate field within the screen.

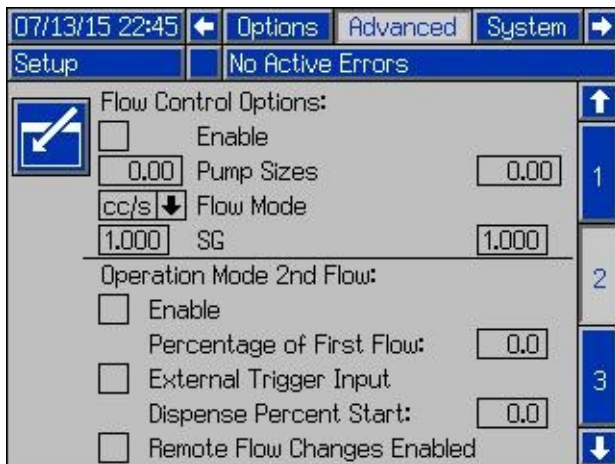

2. At the Pump Sizes field, enter the A and B pump size values in mm² unit of measure.
3. At the SG field, enter the typical or approximate specific gravity of the material.
4. Use the drop down menu at the Flow Mode field to select the desired flow mode as either cc's/sec or g/sec.

NOTE: Operating the machine in weight flow mode configures the counters to track material in grams rather than cubic centimeters, which can simplify the machine operation.

Here is a sample screen with the fields completed.

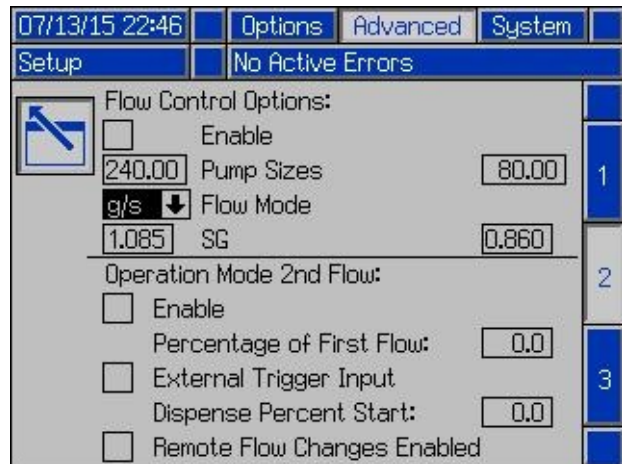

Prime the Dispense Valve



NOTICE

If the dispense valve is not primed, chemical cross-over may occur resulting in cured material in the dispense valve, hoses, and/or pumps.

1. Remove the static mixer from the dispense valve if installed.
2. Turn the snuff back adjustment knob fully clockwise. This will prevent the dispense valve from closing between priming shots.
3. Use a 4 mm hex key to loosen the screws holding the dispense valve in place.

- Rotate the dispense valve so the tip is above the fluid input hoses.

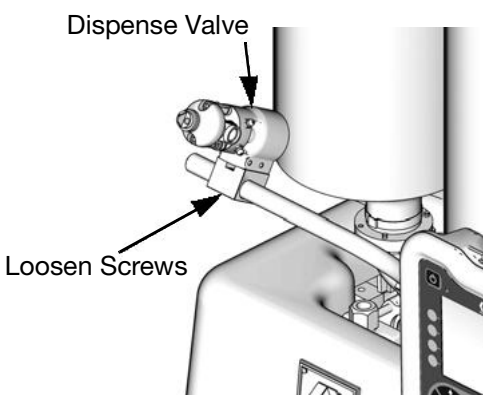



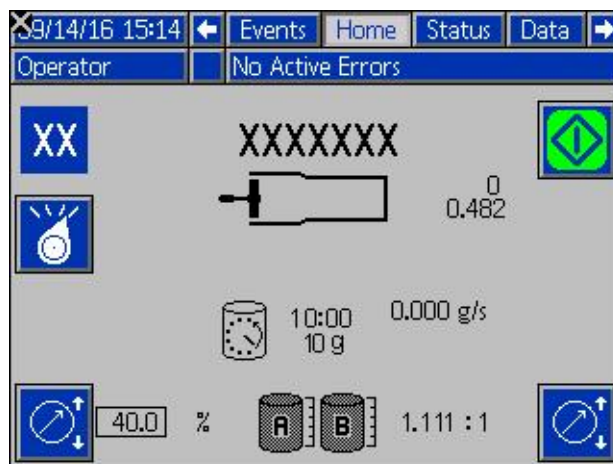





FIG. 8: Dispense Valve

- Use a 4 mm hex key to tighten the screws holding the dispense valve in place.
- Route the fluid hoses connected to the dispense valve so they are always below the dispense valve. This ensures any air in the hoses will travel to the dispense valve.
- At the Home screen, select Operator mode by pressing the  key repeatedly, until the Operator option is displayed. Press  to accept it.
- In the bottom right corner of the screen, verify that the constant torque icon is displayed. If it is not, press the  key until it is displayed.
- Press the key for the torque percentage field located in the lower left part of the screen. Enter a percentage near the mid-range value for the machine air motor (such as 40%). See step 3 on page 25.

- Press  to accept the percentage value.



- Hold a waste container at the end of the dispense valve and press the  key or activate the machine's foot switch.
- Continue to dispense until air is no longer coming out of the dispense valve. Cancel the dispense by pressing the  key or using the foot switch.
- If phasing adjustments and ratio checking are not required, use the following procedure to attach the static mixer.
 - Attach the static mixer with the dispense valve pointing up.
 - Hold a waste container at the end of the dispense valve and press the  key or activate the foot switch.
 - Repeat steps 11-12 until the static mixer has been purged of air.
- Use a 4 mm hex key to loosen the screws holding the dispense valve in place.
- Rotate the dispense valve back to the normal dispensing position.
- Use a 4 mm hex key to tighten the screws holding the dispense valve in place.

Open the Dispense Valve (ODV) Position

When a shot is performed, the dispense valve needs to open at a precise time for material to be dispensed properly. If the dispense valve opens too early, material may drain from the static mixer before the shot starts. If the dispense valve opens too late, pressure may build in the machine before the dispense valve opens, causing material to forcefully spray out of the mixer.

NOTE: Material viscosity also affects timing and needs to be considered when adjusting the Open Dispense Valve (ODV). Thicker materials need to have the dispense valve open earlier and thinner materials should have the dispense valve open later.

A positive value for ODV timing indicates the dispense valve opens after the piston is engaged in the cylinder. A negative value indicates the dispense valve opens before the piston is engaged in the cylinder.

The ODV should be set with reference to the metering tube position. The ODV position determines when the valve is opened as the pumps are extending towards the metering tubes.

1. At the Home screen, set the constant torque percentage to any value other than zero.
2. Press  to access Setup mode. Use the directional keypad to navigate to Calibration screen 2.

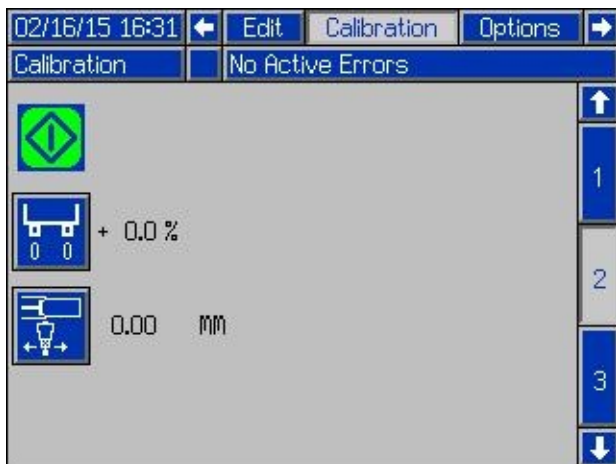

3. Press the  key, then enter an open dispense valve value in the field next to the icon.



4. Use the  key to make the value positive or negative. A negative value indicates that the dispense valve will open that many millimeters (such as 3 mm in the example above) before entering the metering tube. A positive value indicates that the dispense valve will open that many millimeters after it passes the metering tube entrance.

NOTE: Entering a value that would be too far into the metering tube could stall the dispense operations. For most applications, a negative value is recommended.

5. Press  to accept and store the value.

Ratio Setting Adjustment (PR70v Chassis Only)

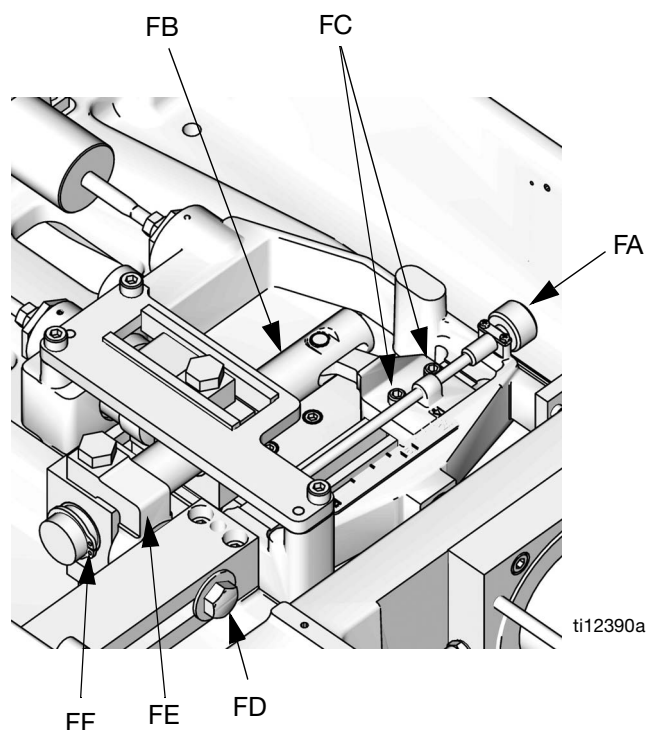

FIG. 9: Variable Ratio Arm Adjustment

Key:

- FA Ratio Adjustment Knob
- FB Ratio Beam
- FC Socket Head Cap Screws
- FD Hex Head Cap Screw
- FE Ratio Beam Guide
- FF Ratio Beam Snap Ring

The PR70 products have ratio selections from 1:1 to 12:1 by simple selection of the pump sizes. Having the PR70F product on the variable ratio chassis (PR70v) provides a ratio multiplier adjustment feature from 1 to 2. As shown by the following table, with the adjustment arm at its maximum multiplier position, the product can provide ratios from 1:1 to 24:1.

A Tube/ Piston Size (mm ²)	B Tube/ Piston Size (mm ²)	Minimum Volumetric Ratio (Arm = 1:1 Position)	Minimum Volumetric Ratio (Arm = 2:1 Position)
960	960	1:1	2:1
960	480	2:1	4:1
960	320	3:1	6:1
960	240	4:1	8:1
960	80	12:1	24:1

The variable ratio chassis also provides the user with more ratio options, which may not be available with the standard pump size selections.

The following procedures must be performed before adjusting the Ratio Arm setting:

- Perform the **Pump Position Calibration** procedure on page 25.
- Enter the **Pump Size** information into the machine.
- Perform the **Prime the Dispense Valve** procedure on page 28.
- Perform the **Open the Dispense Valve (ODV) Position** procedure on page 30.

The correct volumetric ratio set point for the application must be known prior to determining the proper variable ratio arm setting. Using the desired weight ratio set point (unless both materials have a SG of 1.00) will cause calculation errors.



To illustrate the procedure, a desired volumetric ratio of 2.38:1 (or 100:42.0 in 100:xx format) will be used.

- a. Divide the A side piston size by the B side piston size. For example, if the machine has 960:480 pump sizes, then $960 / 480 = 2.00$.
- b. Divide the desired volumetric ratio set point by the piston volume ratio to get the correct ratio arm setting. For example, $2.38 / 2.0 = 1.19$.

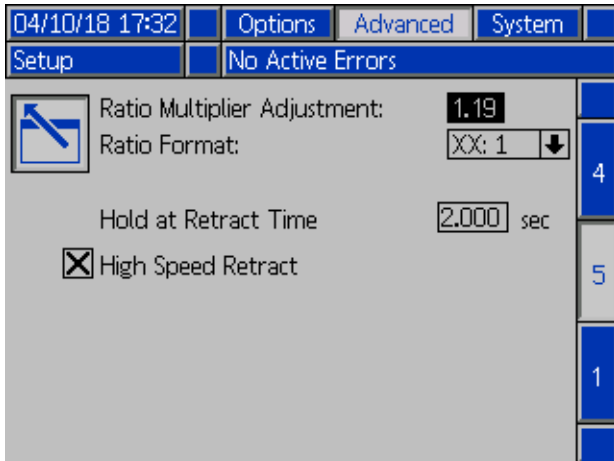
- c. Enter the ratio arm setting value (1.19) into the Ratio Multiplier Adjustment field on the setup Advanced 5 screen as indicated below. This will enable the correct ratio set point to be displayed on the main run screen. This value is also required as an input for the PR70f control logic to provide the correct mixed flow rate for the user.



To adjust the variable ratio arm, perform the following steps in the order presented:

1. Verify the system purge and / or recirculation timer are OFF.
2. Set the system to constant torque mode (“”), with the torque set to 0%.
3. Navigate to the Setup Manual screen, and select the Extend Command Option (“”).
4. By manually pulling on the drive block, extend the pistons until the ratio beam (FB) is perpendicular or nearly perpendicular to the pump shafts.
5. Remove air from the machine by putting the System Air pressure relief switch in the DOWN position.
6. Press the Machine Disable Mode Key (“”).
7. Loosen the socket head cap screw (FC) on the adjustment clevis. See FIG. 9.
8. Loosen the hex head cap screws (FD) on the ratio adjustment pivot.
9. Turn the ratio adjustment knob (FA) clockwise to increase the ratio multiplier, and counter-clockwise decrease the ratio multiplier until the desired setting is reached (1.19 in the example).
10. Tighten the hex head cap screws (FD) on the ratio adjustment pivot.
11. Slide the ratio beam guide (FE) so there is a gap approximately 0.5 mm between the ratio beam guide (FE) and the snap ring (FF) as shown in FIG. 10.
12. Tighten the socket head cap screw (FC) on the adjustment clevis.
13. Return air to the machine by putting the System Air pressure relief switch in the UP position.
14. Put the system back to the correct mode of operation, and torque setting desired.
15. Perform the **Phasing Adjustment** procedure on page 33.

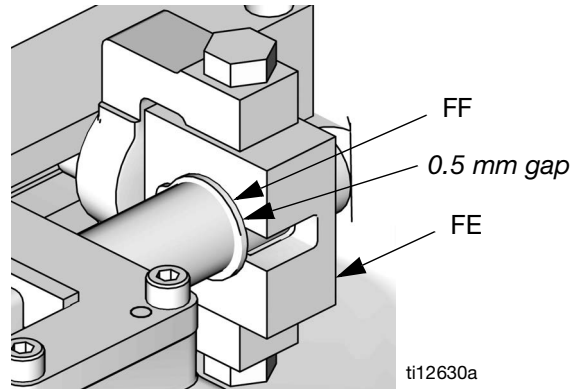

FIG. 10: Ratio Beam Snap Ring

Weight Ratio Check Procedure:

16. Install the Ratio check nozzle onto the dispense valve.

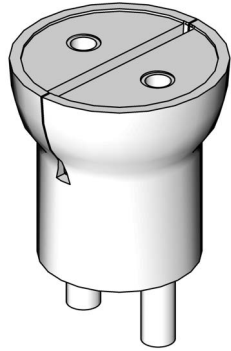





Fig. 11: Ratio Check Nozzle

17. Configure the machine to Shot Mode by using the mode select soft key (“”).
18. Select a shot which does not exceed a single stroke of the pumps.
19. Place a waste container below the dispense valve, and press the Start / Stop shot softkey (“”), or activate the machine foot switch to activate the dispense.
20. Discard the material.
21. Label one scale as “A” and a second scale as “B.”
22. Label one material container as “A” and a second container as “B.”
23. Place container “A” on scale “A” and tare the scale. Place container “B” on scale “B” and tare the scale.
24. Place container “A” under the A material output of the ratio check nozzle. Place container “B” under the B material output of the ratio check nozzle.
25. Press the Stop / Start softkey (“”), or activate the machine foot switch.
26. After the dispense completion, place the “A” container on the “A” scale, and the “B” container on the “B” scale.
27. Divide the “A” weight by the “B” weight to obtain the weight ratio of the dispense. Record the result.
28. Re-tare the A and B scales.

29. Repeat steps 24-28 at least two more times, or as needed.
30. If the average weight ratio is too high or low, repeat steps 2-29 until the dispensing ratio is correct.
 - If the A / B weight ratio is too high, turn the ratio adjustment knob (FA) counterclockwise to adjust the mechanical ratio arm towards the 1:1 position.
 - If the A / B weight ratio is too low, turn the ratio adjustment knob (FA) clockwise to adjust the mechanical ratio arm towards the 2:1 position.
31. Once the ratio check dispense produces the correct weight ratio, tighten all screws holding the ratio beam (FB) in place.
 - Tighten the socket head cap screws (FC) by holding the ratio beam (FB) in place to 140 in-lbs (15.8 N-m).
 - Tighten the hex head cap screw (FD) by holding the ratio guide (FE) in place to 350 in-lbs (39.5 N-m).

Prepare Machine for Operation

32. Remove the ratio check nozzle and install the static mixer or night cap as necessary.

Phasing Adjustment



When the machine executes a shot, materials from Tank A and Tank B enter the static mixer where they are mixed and then dispensed. For the materials to mix at the desired ratio, both materials must enter the static mixer at the same time. The timing of the materials entering the static mixer is dependent on the adjustment of the phase adjustment screw for each piston.

Prepare the Machine

1. Place a waste container under the dispense valve to catch dispensed material.
2. Remove the static mixer from the dispense valve.
3. Install the ratio check nozzle onto the dispense valve

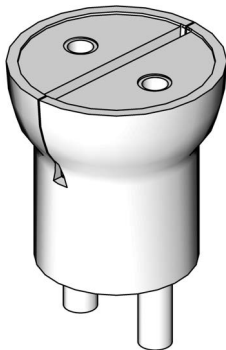







FIG. 12: Ratio Check Nozzle

4. If necessary, place a stand under the ratio check nozzle to support a waste container close to the nozzle.
5. Press  to access Setup mode. Use the directional keypad to navigate to Calibration screen 2.
6. Press the phasing shot  key to enter phasing mode.



7. Press the  key or activate the machine's foot switch to dispense a small amount of material.

8. Adjust the displayed percentage if more than a couple of drops of either material is dispensed or if no material is dispensed from both sides.
 - If too much material is dispensed, decrease the phasing percentage. If necessary, use the  key to switch the percentage from positive to negative.
 - If no material was dispensed, increase the displayed percentage. If necessary, use the  key to switch the percentage from negative to positive.

Adjust the Piston Phase Adjustment Screw

See FIG. 3 on page 16 for the location of the phase adjustment screw and locking nut on the PR70f.

NOTE: It is highly recommended that all of the phasing adjustment be done on one pump or the other, not both.

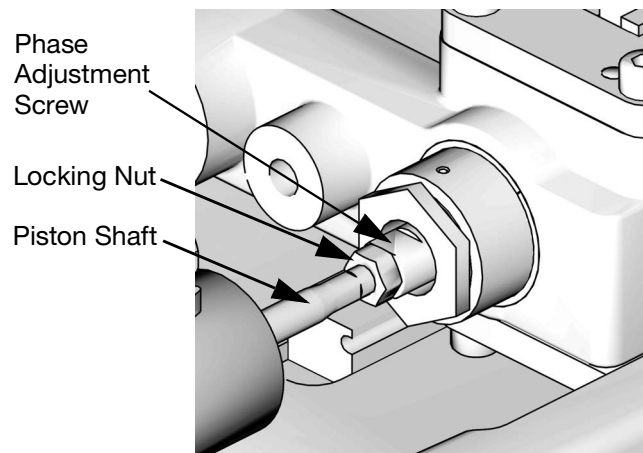



FIG. 13: Phasing Adjustment

9. Watch the dispense valve carefully to observe which material is dispensed first. Press the  key or activate the foot switch to dispense material.

10. If the materials do not exit the dispense valve at the same time, adjust the piston phase adjustment screw as follows. Refer to FIG. 10.

- If the A side material exits the dispense nozzle before the B side material ($\frac{A}{0} \frac{B}{0}$):
 - a. Use two 13 mm wrenches to break loose the locking nut from the phase adjustment screw on the B material side.
 - b. Hold the phase adjustment screw stationary with a 13 mm wrench.
 - c. Use a 7 mm wrench to turn the piston shaft counterclockwise 1/4 turn or less to move the B piston forward.
- If the B side material exits the dispense nozzle before the A side material ($\frac{A}{0} \frac{B}{0}$):
 - a. Use two 13 mm wrenches to break loose the locking nut from the phase adjustment screw on the A material side.
 - b. Hold the phase adjustment screw stationary with a 13 mm wrench.
 - c. Use a 7 mm wrench to turn the piston shaft (301) counterclockwise 1/4 turn or less to move the A piston forward.

NOTE: Ensure the piston shaft and phase adjustment screw do not rotate while tightening the locking nut in the following step. Refer to FIG. 10.

11. Hold the piston shaft and the phase adjustment screw in place with a 7 mm and 13 mm wrench and tighten the locking nut against the phase adjustment screw with a 13 mm wrench.

12. Watch the dispense valve carefully to observe

which material is dispensed first. Press the  key or activate the foot switch to dispense material. If one material exits the dispense nozzle before the other, go back to step 10 and repeat these steps until both materials dispense at the same time.

13. When completed, remove the ratio check nozzle and reinstall the static mixer.

14. To exit calibration mode, press  until you reach the main Home screen.

Adjust the Dispense Valve Snuff Back



At the end of a shot, a small amount of material is drawn back into the static mixer to prevent extra material from being dispensed. If too much snuff back occurs, air can enter the static mixer and travel up into the dispense valve. If too little snuff back occurs, the materials may drip out of the static mixer and affect dispense quantity.

It is most efficient to adjust the snuff back while material is dispensing but it can also be adjusted when there is no air pressure in the system.

1. Navigate to the Home screen. See **ADM Screen Navigation Diagram** on page 21.
2. Select a small size shot.
3. Make sure a static mixer is installed and then prime the machine. See **Prime the Dispense Valve** on page 28.
4. Place a waste container under the static mixer.
5. Press the  key.
6. Inspect the tip of the static mixer for dripping material or for an air bubble traveling up the mixer.
7. Perform another shot and, while dispensing, adjust the snuff back adjustment knob as follows.
 - If an air bubble is moving up the mixer, turn the knob clockwise to decrease snuff back.
 - If material is hanging from the tip of the mixer, turn the knob counterclockwise to increase snuff back.
8. Repeat step 7 until snuff back is adjusted as desired.

Flow Control and Restriction

The PR70f has the capability to control flow over a 1300 to 1 dynamic range. However, other factors can affect the flow range. For example, a 240:240 pump configuration (see **Appendix C - Product Pump Selection Guide** on page 93) can control flow within the following range:

Maximum Flow	56.6 cc/sec
Minimum Flow	0.042 cc/sec
Flow Control Dynamic Range	$56.6 / 0.042 = \mathbf{1347}$



Although the flow control capability is over 1300 to 1 in this example, the actual flow capability can be less than that due to factors such as material viscosity, hose diameters, Hydracheck adjustment, optional orifice diameters installed, air motor size, and so on.

When setting up flow control, mode, these factors need to be considered and adjusted as necessary to obtain the best flow rate.

NOTE: Installing the Hydracheck option is recommended. Flow control performs best if the majority of the pump restriction is external to the material flow (such as from a Hydracheck adjustment) or is from a restriction in the material path prior to the mixing point (such as changing hose diameters).

Set Flow Control Mode

To set up the machine in flow control mode, perform the following steps.

1. Navigate to the Home screen. select Operator mode by pressing the  key repeatedly until the Operator option is displayed. Press  to accept it.
2. In the bottom right corner of the screen, verify that the constant torque icon is displayed. If it is not, press the  key until is displayed.

3. Press the key for the torque percentage field located in the lower left part of the screen. Enter a pressure percentage so the voltage to air regulator display output is approximately 50% of the line air pressure into the machine (approximately 40-45 psi or 3 bar for most locations). See step 3 on page 25 for more information.

NOTE: The flow control option works best when the pressure into the air motor (output of the voltage to pressure regulator) is typically greater than 20 psi (1.33 bar). Having the flow control operate at low level air motor pressures may degrade the flow output stability of the material.

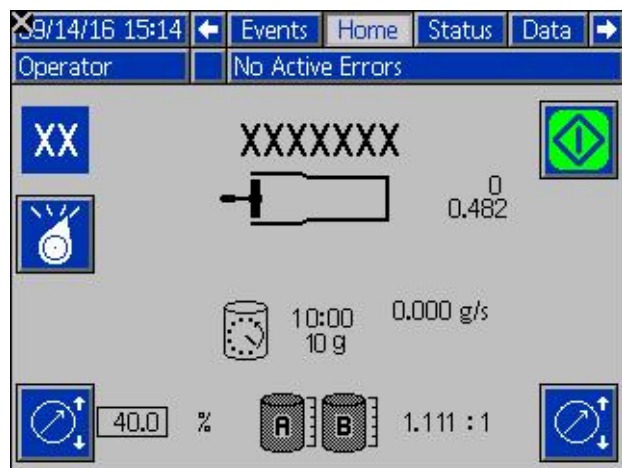

4. Verify that the optional Hydracheck assembly is installed into the machine and that a static mixer is installed, if one is to be used.
5. Place a waste container under the static mixer.
Start a dispense by pressing the  key or activating the machine foot switch.
6. During the dispense operation, observe the thickness of the mixed material and observe the actual flow rate displayed on the ADM screen.

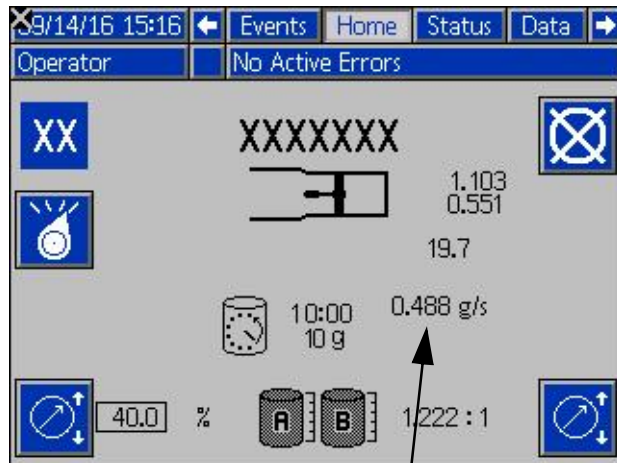

Actual Flow Rate

7. Adjust the restriction until you achieve the desired material bead thickness. As indicated earlier in this section, the restriction can be altered by:

- Adjusting the Hydracheck adjustment screw.
- Adjusting the orifice settings prior to the mixer.
- Changing the output hose diameters.

When the restriction is correctly adjusted, the Home screen displays an actual flow rate near the desired amount. In the example below, the target is a 1.0 g/s rate.



8. To observe the average flow rate for dispensing, use the directional keypad to navigate to the Events screen. The average flow output for each dispense is shown.

02/18/15 14:45 ← Errors Events Home Status →

Shot No Active Errors

#	Date	Time	Code-Class-Event
1	02/18/15	14:45:46	EKDX-R-Shot 45.27g, 48.60sec, 1.045g/s
2	02/18/15	14:44:56	EKDX-R-Shot 35.01g, 55.08sec, 0.961g/s
3	02/18/15	14:43:21	EKDX-R-Shot 25.76g, 78.10sec, 0.377g/s
4	02/18/15	14:27:29	EKDX-R-Shot 5.85g, 19.29sec, 0.389g/s
5	02/18/15	14:26:21	EKDX-R-Shot 3.06g, 18.12sec, 0.240g/s
6	02/18/15	14:26:00	EKDX-R-Shot 10.30g, 31.67sec, 0.184g/s
7	02/18/15	13:46:58	EPDX-R-Purge Shot 17.50g, 95.69sec, 0.184g/s

9. Press until you return to the main Home screen.



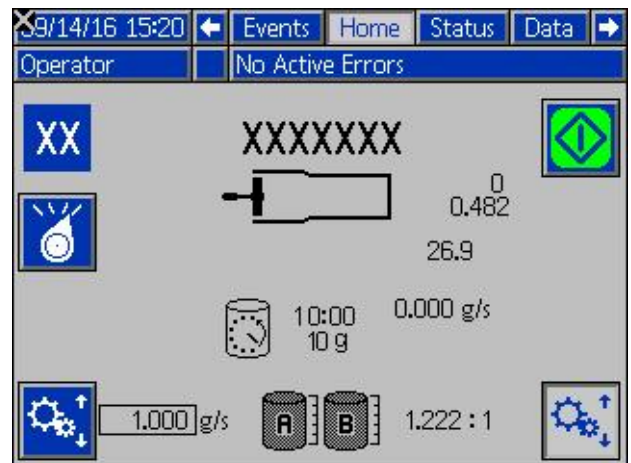

10. If the PR70f is in constant torque mode , press the corresponding key until the icon changes to the constant flow icon .

11. Press the key for the flow setpoint adjustment located in the lower left part of the screen. Enter the desired flow for the next dispense in the field next to the icon.



12. To reset control data after the restriction is altered, press to access Setup mode. Use the directional keypad to navigate to Advanced screen 3.



13. Press the reset control data  key. Press the  key for the flashing  that appears on the screen to confirm erasing the control data or press  to cancel the reset.

14. Press the  key or activate the foot switch to start a dispense. Allow the dispense to continue until the actual flow rate is near the desired setpoint and is stable.



15. Cancel the dispense by pressing the  key or by using the foot switch.

Flow Change During Active Operator Mode Dispense

When the flow rate is set up as described in the section **Flow Control and Restriction** (see page 36), you can alter the flow rate up to a factor of 2 or 3 times in either direction, depending on factors such as the pump configuration or material restriction. If you need to change the flow rate beyond those limits, you may need to further alter the pump restriction.

In Operator mode, you can alter the flow rate during an active dispense using four possible methods.

1 - Manual Flow Change from the Home Screen

The simplest method to change the flow during an active dispense is to alter the flow setpoint on the

Home screen. Press the key for the  icon in the lower left part of the screen while the dispense is active and enter a new flow rate in the field using the ADM's numeric keypad.



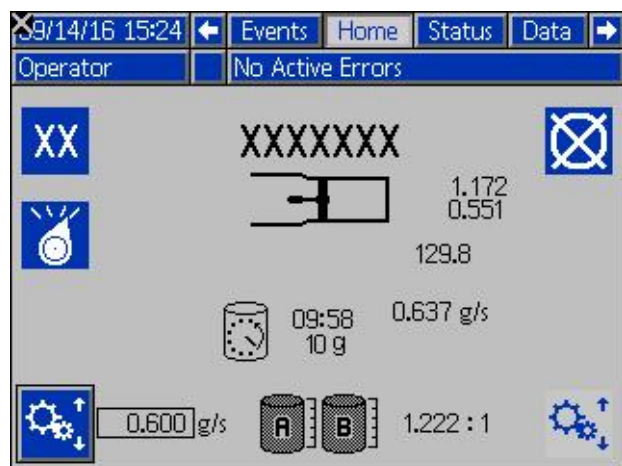

Flow Rate Entry

Press  to accept the change. Once accepted, the actual flow rate adjusts to reach the new flow rate.







2 - Automatic One Time Flow Change

The PR70f can be programmed to change its flow automatically once during an active dispense.

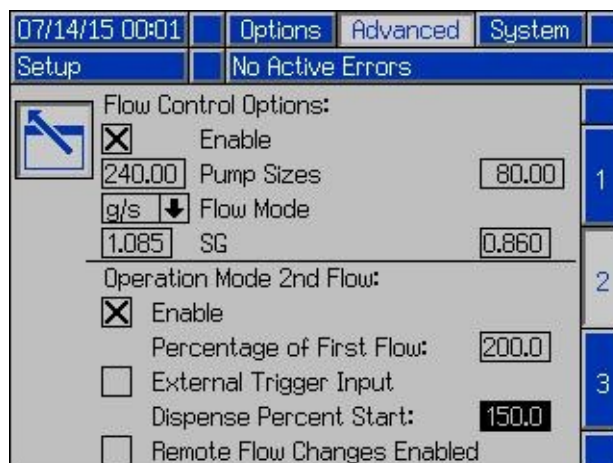
1. Press  to access Setup mode. Use the directional keypad to navigate to Advanced screen 2.
2. Enter the screen by pressing the  key.
3. Use the ADM's directional keypad to navigate to the Operation Mode 2nd Flow section of the screen and perform the following steps.
 - a. **Enable** - Check this field.
 - b. **Percentage of First Flow** - Enter the percentage amount of the 2nd flow rate as it relates to the 1st flow rate. For example, if the 1st flow rate for the dispense is 0.5 g/s and you want the 2nd flow rate to be 1.000 g/s, enter 200.0% into this field. Flow percentages from 30 to 300 are allowed.

- c. **Dispense Percent Start** - Enter when the 2nd flow rate should start in stroke percentage. For example, if the 2nd flow rate needs to start halfway through the 2nd stroke of the dispense, enter 150% into this field.



4. Press the  key to exit the screen.
5. Press  until you reach the main Home screen.
6. Press the  key or activate the foot switch to start a dispense.



Continuing with the examples referenced above, the dispense will operate at the 1st flow rate for one and one half strokes of the pump. When the pistons pass the halfway point through the pump on the second stroke, the flow automatically increases to the 1.000 g/s rate and will continue at that rate until the dispense is canceled.

NOTE: When dispensing in the 2nd flow rate of an automatic rate change, the setpoint that is displayed in the bottom left of the Home screen remains at the 1st flow rate value.



3 - One Time Flow Changes from the Trigger Input

This third method also allows a one-time, automatic flow rate change to be programmed into the PR70f. However, in this method, the change is triggered from an external input instead of waiting for a dispense to reach a stroke percentage point.

NOTE: The external input to trigger the 2nd flow rate is the “SHOT SEL-BIT 0” line. Refer to **External Control Interface Setup** on page 67 for more information.

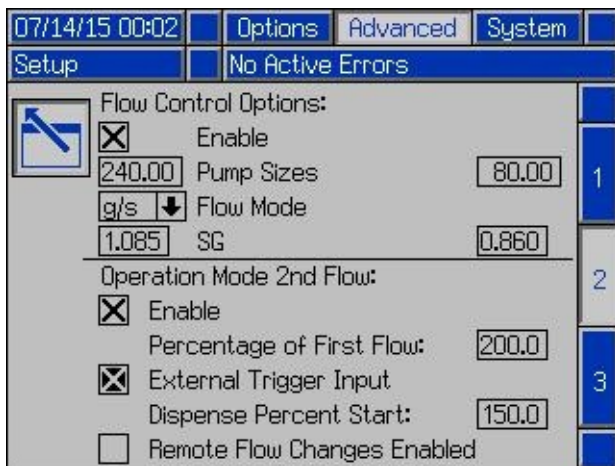
1. Press  to access Setup mode. Use the directional keypad to navigate to Advanced screen 2.
2. Enter the screen by pressing the  key.
3. Use the ADM’s directional keypad to navigate to the Operation Mode 2nd Flow section of the screen.
4. Check the External Trigger Input option and enter an appropriate valve into the Dispense Percent Start field.





5. Press the  key to exit the screen.
6. Press  until you reach the main Home screen.
7. Press the  key or activate the foot switch to start a dispense.

Continuing with the example in the previous page, the dispense will operate at the 1st flow rate until it reaches the Dispense Percent Start value or until the machine receives an active signal on the “SHOT SEL-BIT 0” line (active low), whichever event occurs first.

4 - Flow Changes Using the Shot Select Inputs

A fourth method for changing the flow rate during an active dispense allows for multiple changes during the same dispense. You can select up to 15 different flow rates using the four shot select inputs on the ADM or the external control interface.

1. Press  to access Setup mode. Use the directional keypad to navigate to Advanced screen 2.
2. Enter the screen by pressing the  key.
3. Use the ADM’s directional keypad to navigate to the Operation Mode 2nd Flow section of the screen.
4. Check the Remote Flow Changes Enabled option.

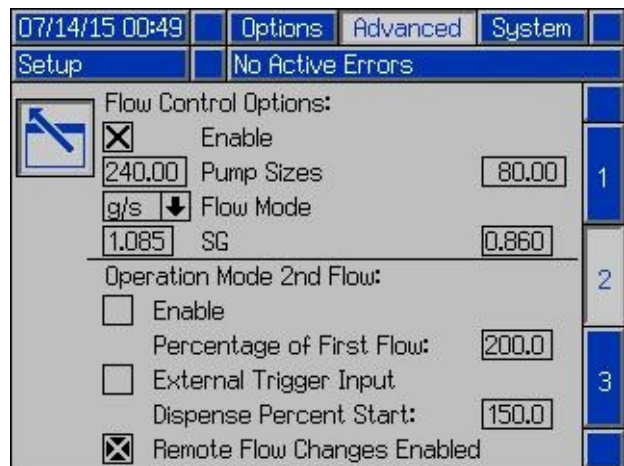

NOTE: When this is selected, the other one-time flow rate changes are turned off.

5. Press the  key to exit the screen.
6. Use the ADM’s directional keypad to navigate to Edit screen 2.

7. Enter the screen by pressing the  key.

Shot	g	g/s	Δg
1	45.00	0.200	- 2.00
2	45.00	0.300	+ 1.00
3	45.00	0.400	- 3.00
4	10.00	0.500	- 4.00
5	35.30	0.750	+ 5.00
6	60.00	6.666	+ 5.00
7	72.00	7.777	- 4.00
8	0.00	0.000	+ 0.00
9	0.00	0.000	+ 0.00
10	100.00	0.256	+ 10.00
11	110.00	0.000	- 11.00
12	120.00	0.000	+ 12.00
13	130.00	0.000	- 13.00
14	0.00	0.000	+ 0.00
15	177.49	0.000	+ 0.00

8. Use the directional keypad to navigate to as many flow rates as you want to change. Enter values using the ADM's numeric keypad. Press  to accept each change.

9. Press the  key to exit the screen.

10. Press  until you reach the main Home screen.

11. Press the  key or activate the foot switch to start a dispense.

Once the dispense is started, the flow rate can be changed by selecting a shot number containing the desired flow rate. Refer to **External Control Interface Setup** on page 67 for information on how to select a shot number.

Continuing with the example used in this section, the dispense will operate at the 1st flow rate of 1.000 g/s. This flow rate can be cut in half by selecting shot number 4, which was entered as 0.500 g/s on the Edit screen in this example. If desired, you can change the flow rate again during the dispense by selecting another shot number.

NOTE: If an invalid or undefined shot number is selected, the ADM or external control interface ignores the selection.

Flow Change During Active Shot Mode Dispense

The one-time flow rate changes (methods 1-3) described in **Flow Change During Active Operator Mode Dispense** on page 38 are also available for an active shot mode dispense.

To enable this feature, press  to access Setup mode. Use the directional keypad to navigate to Advanced screen 4.

Enter the screen by pressing the  key.

Change the control settings to enable the method you want to use as described in **Flow Change During Active Operator Mode Dispense** starting on page 38.

Options	Advanced	System
Setup	No Active Errors	
	Shot Mode 2nd Flow:	
<input checked="" type="checkbox"/>	Enable	
	Percentage of First Flow:	45.0
<input checked="" type="checkbox"/>	External Trigger Input	
	Dispense Percent Start:	0.0
<input checked="" type="checkbox"/>	Flow Changes are Sudden	
<input type="checkbox"/>	Auto-Load Pump After Dispense	
50	Dynamic PreCharge Percent	
<input type="checkbox"/>	Dispense Pause/ Stepping ON	

Edit Functions Setup

NOTE: A shot recipe is a combination of a shot amount and a shot rate for a specific shot selected.



The Edit setup screens provide settings for the shot recipes and a sequence of shot recipe details. Edit screens 1 and 7 are used to define the 100 possible shot recipes and screens 8-11 are used to define sequences A through G.

Shot Definition

At the Home screen, press  to access Setup mode. Use the directional keypad to navigate to Edit screens 1-7.

01/07/20 14:43		Manual		Edit	Calibration
Shot		DJDX-D-Linear Sensor Fault			
##	g	g/s		Δg	
31	45.00	1.000	+	0.50	
32	5.50	1.000	+	0.00	2
33	0.00	0.000	+	0.00	
34	0.00	0.000	+	0.00	
35	0.00	0.000	+	0.00	
36	0.00	0.000	+	0.00	
37	0.00	0.000	+	0.00	3
38	0.00	0.000	+	0.00	
39	0.00	0.000	+	0.00	
40	0.00	0.000	+	0.00	
41	0.00	0.000	+	0.00	
42	0.00	0.000	+	0.00	4
43	0.00	0.000	+	0.00	
44	0.00	0.000	+	0.00	
45	0.00	0.000	+	0.00	

Shot Number Shot Amount Shot Dispense Rate Shot Delta Amount

1. Enter the screen by pressing the  key.
2. Use the directional keypad to navigate to the shot amount or dispense rate to be edited.
3. Enter a new shot amount and/or dispense rate in the appropriate column using the numeric keypad.
4. Press  to accept each change.



NOTE: If the shot amount entered is too small or the dispense rate entered is too fast or slow, the ADM emits three fast beeps and acceptable values are displayed to accept or change. If using the machine for Small Amount dispensing described in **Appendix D - Small Amount Shot Mode Dispensing** on page 102 (Auto-Load Pump After Dispense feature is turned ON), any small amount required can be entered.

5. Repeat steps 2-3 for any additional shot numbers that need to be edited.
6. If the shot recipe needs a non-zero delta amount (Δg), navigate to the last column for the shot recipe as shown below.

01/07/20 14:44		Manual		Edit	Calibration
Shot		50X-A-Improper System Cal			
##	g	g/s		Δg	
31	45.00	1.000	+	0.50	
32	5.50	1.000	-	0.25	
33	6.50	1.200	+	-0.33	2
34	0.00	0.000	+	0.00	
35	0.00	0.000	+	0.00	
36	0.00	0.000	+	0.00	
37	0.00	0.000	+	0.00	
38	0.00	0.000	+	0.00	3
39	0.00	0.000	+	0.00	
40	0.00	0.000	+	0.00	
41	0.00	0.000	+	0.00	
42	0.00	0.000	+	0.00	4
43	0.00	0.000	+	0.00	
44	0.00	0.000	+	0.00	
45	0.00	0.000	+	0.00	

7. When in the last column for a shot recipe, as shown above, the  key is shown on the screen and allows the user to set the delta amount to a positive or negative value.

NOTE: The actual shot amount used by the machine for a shot recipe is the sum of the shot amount and the shot delta amount. When on the main Home screen, only the shot amount will only be shown. For example, if shot recipe #32 is selected, the machine will dispense 5.25 grams of material (5.50 +/- 0.25 grams) at a rate of 1.000 g/s. On the main Home screen, only 5.50 grams will be displayed.







8. Repeat steps 6-7 for all shot recipes that require a non-zero delta amount.
9. Press the  key or the  key to exit the screen when finished.

Sequence Definition and Mode Description

There is an option in Sequence mode to allow the PR70f to automatically perform all of the shots in a sequence with a preset delay between shots. This process is called auto-sequencing.

The pause duration between shots for auto-sequencing is configurable at Edit screens 8-11.

1. Use the directional keypad to navigate to Edit screen 8-11 depending on which sequence you want to edit.
2. Enter the screen by pressing the  key.

3. Use the directional keypad to navigate to the corresponding Auto check box for the sequence you are going to edit.
4. Select it by pressing .
5. Use the directional keypad to move to the shot number of the sequence position (row) you want to edit.
6. Select it by pressing , then select a predefined shot number (with a non-zero amount) using the up and down arrow keys (, ).
7. Once the correct shot number has been found, press  to accept the change.
8. To add this shot to the auto-sequencing, move to the pause duration column for that shot and enter a duration (in seconds) using the numeric keypad.
9. Press  to accept the change.

Auto Sequence Check Box

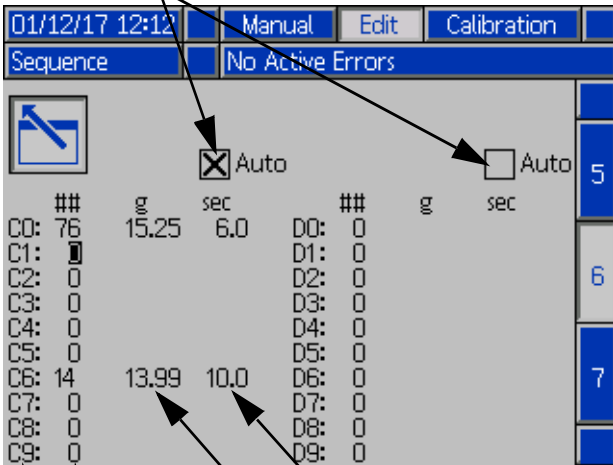

##	g	sec	##	g	sec
C0:	76	15.25	D0:	0	
C1:	0	6.0	D1:	0	
C2:	0		D2:	0	
C3:	0		D3:	0	
C4:	0		D4:	0	
C5:	0		D5:	0	
C6:	14	13.99	D6:	0	
C7:	0	10.0	D7:	0	
C8:	0		D8:	0	
C9:	0		D9:	0	

Shot Number
Pause Duration

Sequence Position
Shot Amount

NOTE: If the auto-sequence option (Auto) is not selected, the pause duration column cannot be edited. A dispense would have to be triggered by pressing the



key at the Home screen or activating the machine's foot switch.

10. Repeat steps 5-9 for additional sequence positions that need to be edited.

11. Press  to exit the screen when finished.

Not all positions in a sequence need to be completed. In the example screen above, the sequence is manually

started by pressing the  key or activating the foot switch.

After the machine completes shot #10 (sequence position 0), it pauses for 2 seconds and then automatically dispenses shot #11, followed by a 3 second pause, and shot #12, followed by a 4 second pause.

The sequence then skips positions 3-6 and starts dispensing the 9.99 gram shot in position #7. Once the 5 second pause duration from position #7 expires, the sequence resets to position 0 and remains idle until restarted.

There are several ways to stop the sequence. You can

press  or activate the foot switch. You can abort

the pause duration by pressing the  key to start the next shot in the sequence. Also, you can press the



key on the Home screen in Sequence mode.

Options Setup

Fluid Options



At the ADM's Home screen, press  to access Setup mode. Use the directional keypad to navigate to Option screen 1.

The fields on this screen will be different based on the configuration of the PR70f. If the machine is configured with one Fluid Control Module (FCM), only low level fluid sensors can be used. If it is configured with two FCMs, high level sensors can be used.

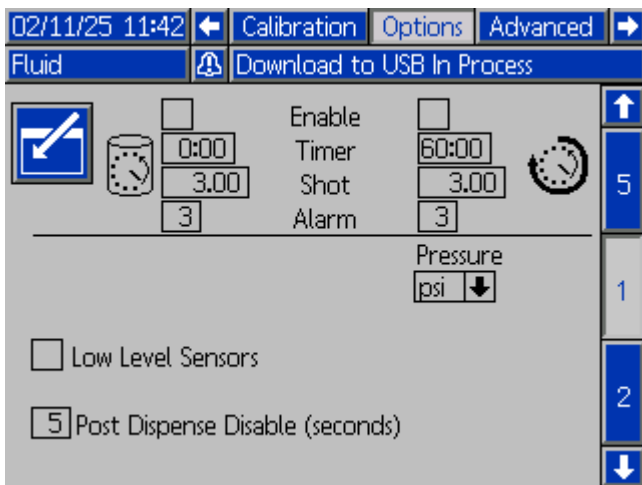
Low Level Sensors



The low level sensors can be enabled or disabled. Disabling the low level sensors disables low level alarms. If the low level sensors are disabled, the tank icons on the Home screen will be gray.

1. To enable or disable low level sensors, press the  key to enter the screen.
2. Use the directional keys to navigate to the Low Level Sensors check box.
3. Press  to enable or disable the sensors (check or un-check the box).
4. Press the  key to exit the screen.

Post Dispense Disable

The post dispense disable is a feature where the user can disable requests for one to five seconds after the completion of a dispense. Setting the value to zero turns off the post dispense disable feature.

Purge and Recirculation Timers

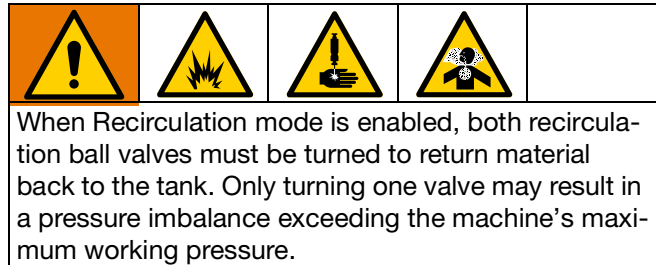

NOTE: To use Recirculation mode, 3-way ball valves must be installed at the dispense valve. Fluid lines must be installed going from the ball valves back to the tank.



The Purge Timer and Recirculation Timer behave in a similar way, with a certain shot size being executed after the timer delay has elapsed. The difference is that the purge timer operates with the dispense valve open so a purge shot is executed. The recirculation timer operates with the dispense valve closed so no material is dispensed when the shot is executed.

Both timers feature an adjustable alarm to warn you that the piston drive block is to begin moving. The alarm setting is the number of seconds before the shot is to be executed.

When Recirculation mode is enabled, both recirculation ball valves must be turned to return material back to the tank. Only turning one valve may result in a pressure imbalance exceeding the machine's maximum working pressure.

1. To configure the timer settings, press the  key to enter the screen.
2. Use the directional keys to navigate to the Purge Timer or Recirculation Timer Enable check box.
3. Press  to enable or disable the selected item.
4. (check or un-check the box).
5. Navigate to the other fields using the directional keys and make the necessary changes. Use the numeric keypad to enter the new value.

6. Press the  key to exit the screen.

High Level Sensors

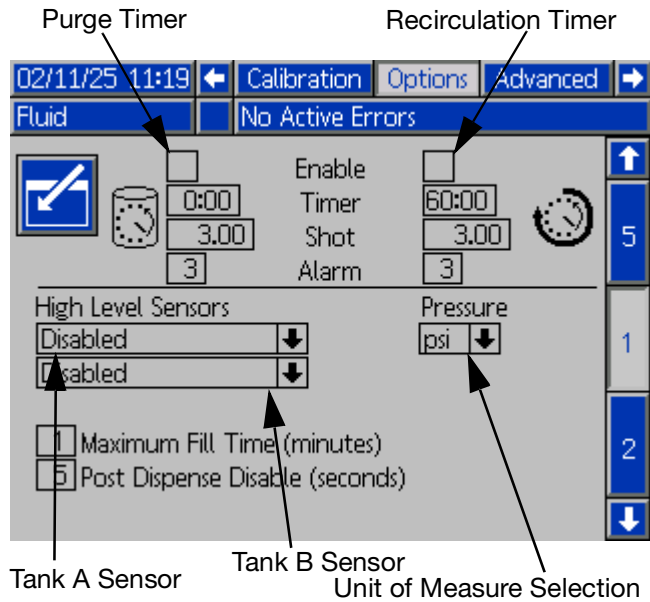

NOTE: See the PR70 and PR70v Feed Systems Manual 312394 referenced in **Related Manuals** on page 3 for the vacuum auto-fill procedure.







With high level sensors installed, auto-refill can be used. The high level sensors have multiple auto-refill modes ranging in function.

- **High Level Auto-Refill** refills the tank when material is below the high level sensor. This mode is recommended for applications with temperature control.
- **Empty Auto-Refill** refills the tank when a low level condition is seen.
- **Manual Auto-Refill** requires you to manually initiate tank refill.
- **Monitor High Level** mode simply displays the current fluid level on the Home screen. This selection should be chosen only if low level sensors are installed for the respective tank.
- **Accumulator** mode refills the accumulators automatically when a low level condition is seen.

Follow these steps to edit the high level sensor fields.

1. Press the  key to enter the screen.
2. Use the directional keypad to navigate to the item to be changed.
3. Press  to open the drop-down menu.
4. Use the directional keypad to select the new mode.
5. Press  to accept the new mode.

NOTE: The Maximum Fill Time function allows you to specify a maximum amount of time for refilling the tank. If after the input amount of time the tanks are not full, an alarm is displayed.

6. Use the directional keypad to navigate to the Maximum Fill Time (minutes) field.
7. Use the numeric keypad to enter the new value.
8. Press  to accept the new value.
9. Navigate to the Pressure field.
10. Press  to open the drop-down menu.
11. Use the directional keypad to select the unit of measure.
12. Press  to accept the selection.
13. Press the  key to exit the screen.



Heat Options



The Heat Options setup screen includes options for the tank and hose heaters. Each tank and hose heater can be enabled and disabled and each have their own settings.

Enable/Disable Heat Options

All heat options can be enabled or disabled. All options that are installed should be enabled and all that are not installed should be disabled. All enabled heat options can be turned on and off from the Home Screen. To enable or disable heat options, perform the following procedure.

1. Press the  key to enter the screen.
2. Use the directional keypad to navigate to the item to be changed.
3. Press  to enable or disable the selected item (check or un-check the box).
4. Navigate away from the Enable/Disable field to accept the change.

Zone Numbers

Each tank and hose heater is assigned to a specific zone number. The zone number refers to the zone number on the Integrated Heat Assembly. Each zone number has a label above it. See FIG. 11.

The zone number specified for each option on the Heat Options setup screen needs to match how the system is connected. For instance, if tank A is connected to zone #1, then zone #1 needs to be selected for tank A heat.

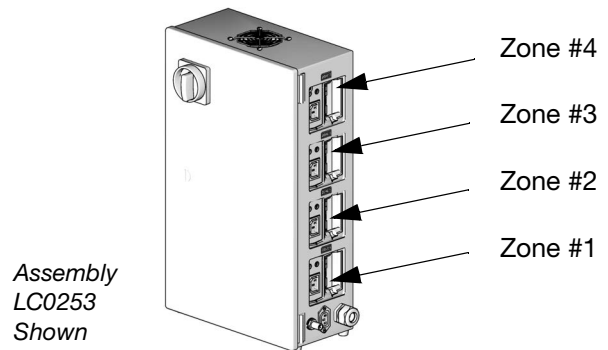









FIG. 14: Integrated Heat Assembly, Zone Numbers

To change a zone number, the applicable tank or hose heater must be disabled.

NOTE: No two zones may have the same zone number assigned at any point. To change a heat option zone number to a zone number already assigned to another heat option, the existing assignment must first be changed to either another zone number or "--".



1. Press the  key to enter the screen.
2. Use the directional keys to navigate to the Enabled box for the heat option that will have its zone number changed.

3. Press  to disable (un-check) the heat option.
4. Use the directional keypad to navigate to the heat option Zone field.
5. Select it by pressing .
6. Use the up arrow () or the down arrow () to change the value.
7. Press  to accept the change.
8. Use the directional keys to navigate back to the Enabled box for the heat option that you changed.
9. Press  to enable (check) the heat option.
10. Repeat steps 2-9 for all heat option zone numbers that you are changing.

Temperature Settings

Each tank and hose heater has a high and low temperature alarm and a temperature setpoint. The tanks also have a blanket heater temperature setpoint.

An alarm sounds when the material temperature is outside of the range given by the high and low temperature setpoints. Also, dispensing may be disabled depending on the selections made in System Options on this page.

1. Press the  key to enter the screen.
2. Use the directional keypad to navigate to the temperature setting to be changed.
3. Use the numeric keypad to enter the desired temperature in the displayed units (Celsius or Fahrenheit).
4. Press  to accept the new value.
5. Press the  key to exit the screen.

System Options

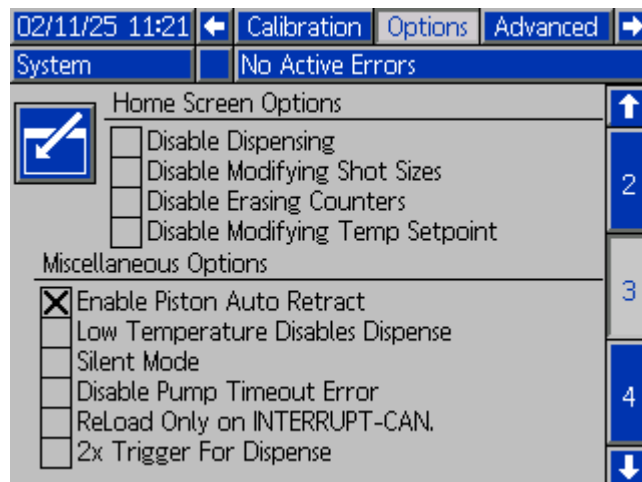

Home Screen Options

These options disable certain functions on the Home screen. Some of the functions can still be performed using the Setup screens. When using these options, it is recommended that the Setup screens are protected by a password; see **Advanced Functions Setup** on page 50.



- **Disable Dispensing** disables dispensing from the Home screen.
- **Disable Modifying Shot Sizes** disables editing shot size definitions from the Home screen.
- **Disable Erasing Counters** disables erasing shot counters on the Data screen.
- **Disable Changing Temperature Setpoint** disables changing the temperature setpoint from the Home screen.

Miscellaneous Options

- **Enable Piston Auto Retract** enables the piston to automatically retract if left idle in the metering tube or tube entrance for more than approximately four minutes. If this feature is turned off, the user will be responsible to retract pumps after use.
- **Low Temperature Disables Dispense** disables dispensing if the material temperature is below the low temperature setpoint.
- **Silent Mode** disables all audible alerts.

- **Disable Pump Timeout Error** disables the error that occurs if the piston stops or slows down too long in the metering tube. Disabling it might be required if a thicker material is being used that slows down the piston.
- **Reload Only on INTERRUPT-CAN.** - If using the external control interface, checking the “Auto Load Pump After Dispense” feature will configure the PR70f to only reload the pumps with an active INTERRUPT-CAN. signal, rather than retracting the pump if the pumps are already fully loaded. In this configuration, the user can retract the fully loaded pumps by pressing the reload / retract softkey (”).
- **2X Trigger for Dispense (LP)** will require the trigger or footswitch to be tapped/triggered twice before the PR70F will acknowledge the dispense request. The same double tap/trigger sequence will require the user to cancel and active dispense using the trigger or footswitch. This does not apply to requesting a dispense from the ADM.

Enable/Disable Options

1. Press the  key to enter the screen.
2. Use the directional keypad to navigate to the item to be changed.
3. Press  to enable or disable the selected item.
4. Navigate away from the Enable/Disable field to accept the change.
5. Press the  key to exit the screen.

Dispense Check Options

The PR70F product has two dispense check options to detect if there is a problem with a pump, hose, or if an out of material or off ratio condition exists while dispensing from the machine. The first option is provided with the machine, and the 2nd (Ratio Verification) is an optional system, requiring additional flow meter hardware for operation.

Low Pressure Error Generation Feature

This feature is intended to detect a failure with a pump piston, hose, or the lack of material in one of the pumps. It also indirectly detects if an off ratio condition exists for a dispense. This feature can be configured and turned On or Off on the Setup Options #4 screen, as illustrated below:

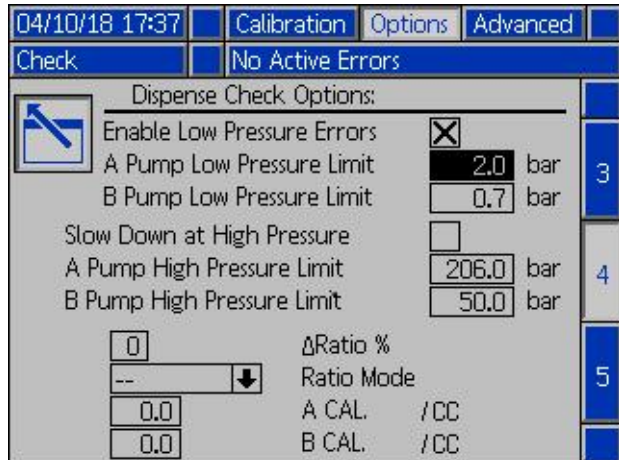

Field	Value	Unit
Enable Low Pressure Errors	<input checked="" type="checkbox"/>	
A Pump Low Pressure Limit	2.0	bar
B Pump Low Pressure Limit	0.7	bar
Slow Down at High Pressure	<input type="checkbox"/>	
A Pump High Pressure Limit	206.0	bar
B Pump High Pressure Limit	50.0	bar
ΔRatio %	0	
Ratio Mode	--	
A CAL.	0.0	/CC
B CAL.	0.0	/CC

Enable Low Pressure Errors turns the feature On or Off. The feature is turned ON only if this field is checked.

A & B Pump Low Pressure Limit defines the minimum pressure allowed (in PSI or Bar units, depending Pressure Options #1 screen setting) while dispensing before a “Low Pressure” deviation or error is generated for the respective pump. If a 0 is entered for the field, the logic will NOT generate a low pressure error for that respective pump.

A & B Pump High Pressure Limit and **Slow Down at High Pressure** are features for dispensing pressure sensitive materials, which are typically materials filled will hollow spheres. If one of the materials dispensed is pressure sensitive, enter the maximum dispense pressure in the corresponding “Pump High Pressure Limit” field. If the pressure in a pump reaches the entered value during a dispense, the dispense will be affected in one of two ways. If the “Slow Down at High Pressure” field is NOT checked, the dispense will terminate and an over-pressure warning will be generated. If the “Slow Down at High Pressure” field is checked, the pump will reduce its flow and dispensing will continue. If an over-pressure flow reduction occurs, a “Flow Reduced High Pressure” advisory will be generated. If this feature is not needed, enter any large pressure value into the corresponding “Pump High Pressure Limit” fields.

Ratio Verification Feature

This optional feature requires Ratio Monitoring components (Flow Meters) and is not a standard component of the PR70F product. It's setup and configuration uses the remaining portion of Options #4 and all of Options #5 screens. Refer to the PR70 and PR70V with Advanced Display Manual 312759 for detailed information about this feature.

Tank Filling Options

If the high level sensors on the PR70f tanks are set to anything other than Disabled or Monitor only (see **High Level Sensors** on page 45), the user can initiate or cancel an existing fill operation by pressing the second soft key on the right side of the main home run screen

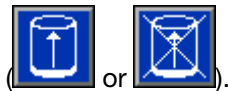

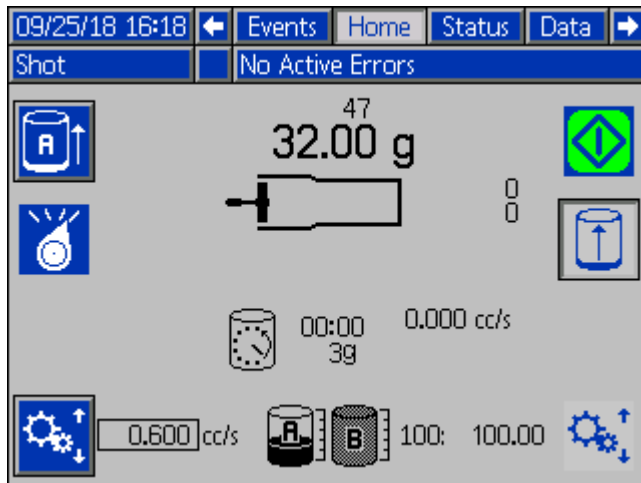

To initiate a manual tank fill operation:

1. Press the  key on the main run screen. The machine will prompt the user to select a desired tank to fill.



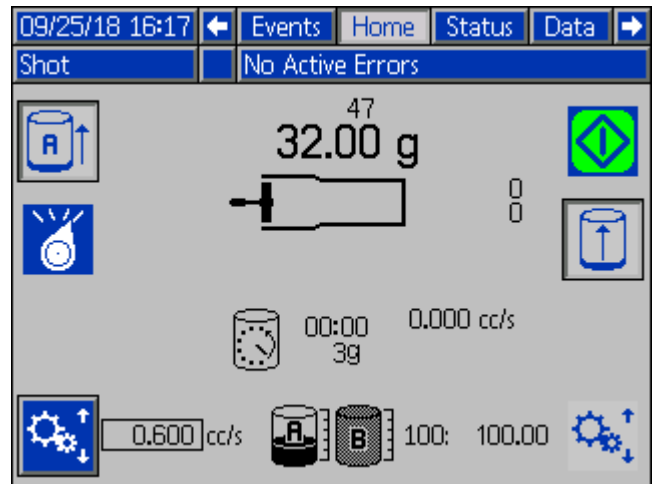

2. Press the corresponding soft key to select the desired tank.



3. Press either the  soft key, or the enter key () to begin filling the selected tank.

Once filling starts, the second right soft key graphic will

change to , indicating the user can abort the filling process. If  is pressed, the tank filling process will be aborted.









If a manual fill is started or aborted (automatically or manually) before the tank is completely filled, a log element will be generated for the event. The log element can be viewed in the USB logs or Error run screen (system versions 1.01.011 or later).

Advanced Functions Setup

Advanced Screen 1

Edit Settings

- To make changes at this screen, press the  key to enter the screen.
- Use the directional keypad to navigate to the item to be changed.
- For numeric entries**, use the numeric keypad to enter the new value.
For non-numeric settings, press  then use the up arrow () and the down arrow () to change the selection.
- Press  to accept the new value or selection and exit editing mode using the  key.

Language

The Language selection feature allows you to change the language of all text on the display module. Available languages are English, Spanish, French, German, Chinese, Japanese, Korean, Russian, and Italian.

Temperature Units

Select either Fahrenheit (F) or Celsius (C) for the temperature unit.

Date Format

There are three available date formats to choose from: MM/DD/YY, DD/MM/YY, and YY/MM/DD.

Current Date and Time

Enter numeric values for the month, day, four-digit year, hour (24-hour clock), and minutes.

Password

If a password other than "0" is entered, the password is automatically enabled. The password protects entry into the Setup screens. With the password enabled, you can still change shot sizes, erase counters, or modify temperatures. See **System Options** on page 47.

Screen Saver

The screen saver turns off the screen back-lighting after the number of minutes entered here. To disable the screen saver, press any button.

Advanced Screen 2

Advanced Screen 2 includes critical entries that are required for operation of the PR70f. For a description of these functions, refer to the following sections in this manual:

- **Pump Size, SG, and Flow Mode** on page 28
- **Flow Change During Active Operator Mode Dispense** on page 38.

Advanced Screen 3

A portion of the content on this screen pertains to resetting the flow control data after the PR70f's material restriction is adjusted. See the section **Flow Control and Restriction** on page 36 for information about that operation.









About the Material Counters

During operation, the amount of material being dispensed for both the A and B pumps is being tracked. If the machine has been configured for weight flow (g/second), the counters show the weight in grams and if it has been configured for volumetric flow (cubic centimeters/second), the counters show the volume in cc units. The flow control is selected on Advanced screen 2 and is described in the section **Flow Change During Active Operator Mode Dispense** on page 38.

Reset the Batch Material Counters

NOTE: Each pump has two counters: a batch material counter that can be reset and a total material counter that cannot be reset.



1. At the Home screen, press  to access Setup mode. Use the directional keypad to navigate to Advanced screen 3.
2. Press the top left key next to the  icon. This changes the icon to  and highlights the batch material counters. The  icon appears on the screen and is flashing.
3. Press the key next to the flashing  icon to reset the counters. When completed, the batch material counters will be reset to zero, the  icon will disappear from the screen and the inverted  key will return to .

Advanced Screen 5

This screen contains several miscellaneous entries which do NOT pertain to the variable ratio feature of the product.

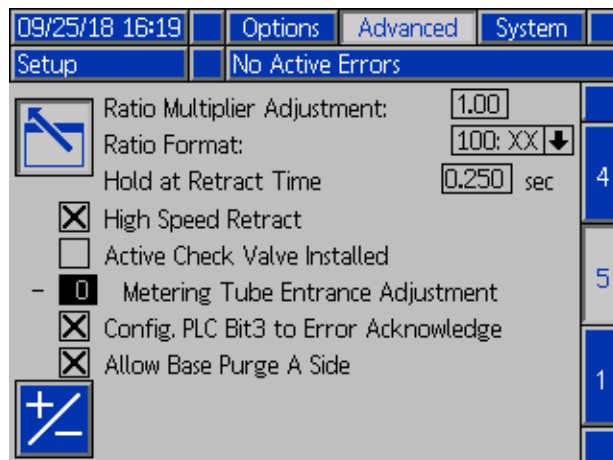



Hold at Retract Time is intended for dispensing thick material which may take additional time to load into the pumps while they are in the retract position. If additional time is needed, enter the desired value in the “Hold at Retract Time” field. The default value of 0.1 seconds is typically used for low viscosity dispense materials.

High Speed Retract is a function which can be implemented when the PR70F is dispensing with the “Flow Control” feature turned ON. If implemented, the logic will command the air motor to a maximum setting during the pump retract process.

Active Check Valve Installed must be checked if an active check or ball valve is installed between a pump output and the input to the MD2 valve. This valve is typically installed when dispensing pressure sensitive materials, which usually contain hollow spheres. For these applications, dispenses are intended to start from the full retract position and NOT from the entrance of the metering tubes. If the active valve is NOT installed (most applications), verify the check box option is NOT checked.

Metering Tube Entrance Adjust is a software method of adjusting the location of the metering tube entrance position previously entered in the hardware calibration

#1 screen (“”) soft key option, described on page 27). For example, if the user enters minus (“-”) 22 as in

relation to the 2363 “” position outlined on page 27, the resulting metering tube entrance position would be 2341 (2363 + - 22 = 2341). The resulting position would be slightly before the physical 2363 position when the pump is extending.

Typically, a negative entry for this field is used in bead dispensing applications to help reduce the initial amount of material dispensed (reduce the “snake head”) when the pumps are first loaded at the metering tube entrance. If the pump pistons start to wear due to significant use, the user may want to reduce the negative amount of this field, or enter a positive number.

Config. PLC Bit3 to Error Acknowledge, if checked, means Bit3 of the PLC interface shot select bits will be re-assigned to an Error Acknowledge function. If an active Error Pop-Up window is present on the screen, transitioning this input bit from low to high is the same as pressing the return key on the ADM () , allowing the user to acknowledged the error and remove the error pop-up window.

If this option is checked, the user will only be able to select the first seven shot recipes (if in shot mode) or flow rates (if in operator mode). See **Advanced Functions Setup** on page 50 for more details.

Base Purge Operation

Allow Base Purge A Side is an Advanced Screen #5 option which will appear if the PR70F has the “Accumulator” fill option selected for the A side “High Level Sensors” option, as indicated in the Options #1 screen shown below.

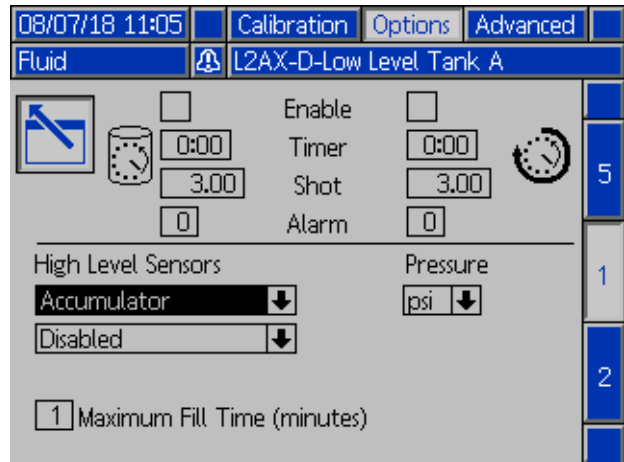

If the “Allow Base Purge A Side” option is checked, an additional Base Purge soft key option will be available on the main home run screen, as indicated below.

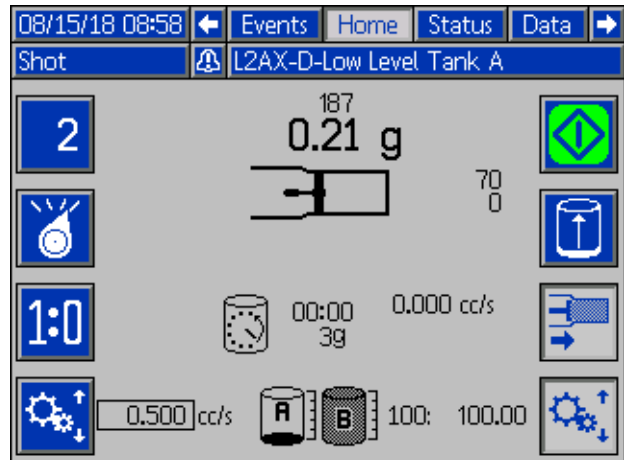

If the user presses the “” purge option (enabled when the machine is NOT dispensing), the machine will activate the A side feed, open the dispense valve, and open the active Ball valve (if installed) to enable the user to fill the static mixer with the A side material only. When a base purge operation is active, the home screen will indicate the base purge is active, as shown below.

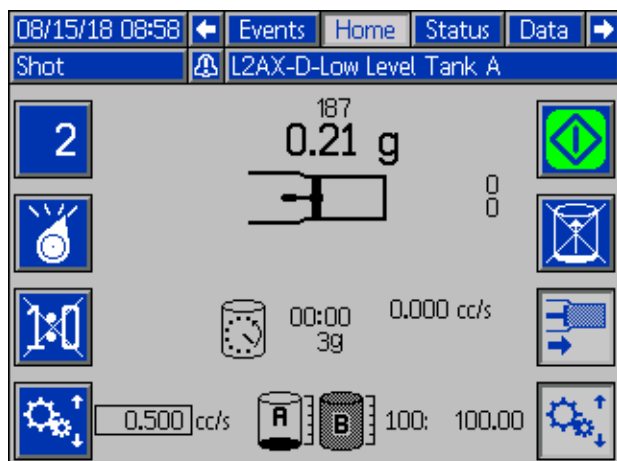

When the static mixer is properly filled with the A side material, the user can cancel purge operation by press-

ing the abort base purge soft key (“”).

Operation

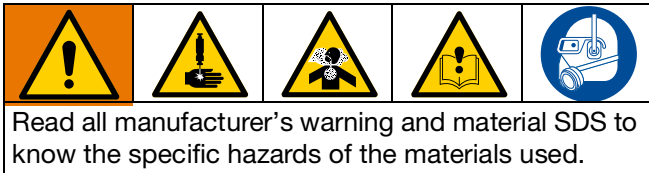

For information about basic functions on the Home screen, see **Home Screen Features** on page 23.

Sequence Mode

In sequence mode you can manually execute a sequence of shots or automatically start the shot sequence after the expiration of the sequence position timer. When executed manually, each dispense in the sequence is started from the ADM or the foot switch.

Select Sequence mode by pressing the  key repeatedly, until the Sequence option is displayed.

Press  to accept it.

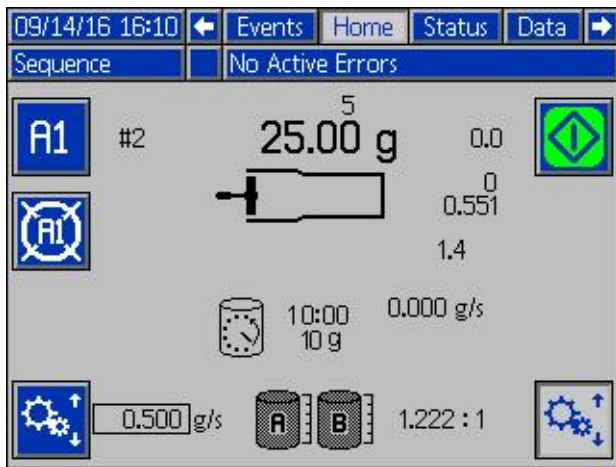





The sequence letter and sequence position are shown in the icon in the upper left corner of the screen. The

 icon, as shown above, is an example. The field next to the icon shows the shot number for that sequence letter and position. For more information about shot sequences, see **Edit Functions Setup** on page 41.

You can change the active sequence at this screen.

1. Press and hold the  key for 4 seconds. The sequence letter designation is highlighted and arrow keys appear.

2. Use the up or down arrow keys (, ) on the directional keypad until the desired sequence appears on the icon.

3. Press  to accept it or press  to keep the previous value.

NOTE: You can also reset the active sequence to the first position by pressing the  key.

Variable Ratio Controls

The PR70F can be provided on the PR70 variable ratio chassis (PR70v), which provides a 1.0 – 2.0 variable ratio multiplier arm. If the multiplier arm is set to 1.0, the volumetric ratio is determined by the ratio of the pump sizes. In this setting, a 480:240 mm² pump configuration would have a volumetric ratio of 2:1 (or 100:50 in 100:xx format). If the ratio arm is set to 2.0, the volumetric ratio for a 480:240 pump configuration would now be 4:1 (100:25 in 100:xx format). The ratio arm can also be set to any increment between 1.0 – 2.0.

When adjusting the Variable Ratio arm to the desired location, inform the logic of the setting by entering the adjustment number on the **Ratio Multiplier Adjustment** field, on the Advanced #5 screen.

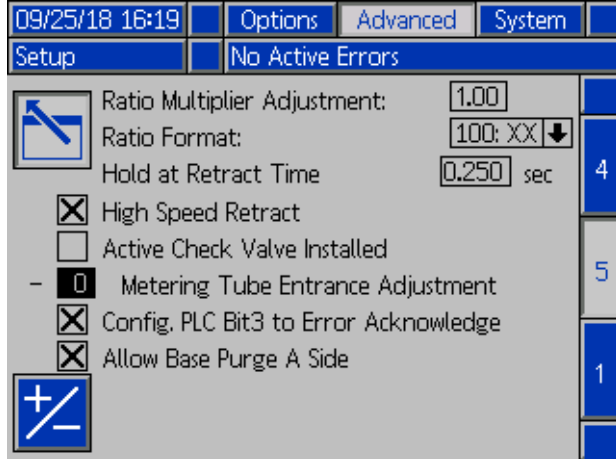

If the PR70F is on the fixed ratio chassis, enter 1.0. The PR70F will use this entry to properly provide the correct requested flow for a dispense. The control logic also uses the pump size entries, Ratio Multiplier Adjustment, and material SG entries (if in weight flow mode) to determine the correct shaft speed for the requested flow.

Run Screen Ratio Set Point

On the bottom right side of the main home run screen, the ratio set point is displayed for the user. The ratio value displayed is either a volumetric ratio when dispensing in volumetric flow mode (CC/sec), or a weight ratio if dispensing weight flow (g/sec). The volumetric or weight flow mode selection is found on the Advanced #2 screen. When the ratio is volumetric, the value is determined by the ratio of the pump sizes and Ratio Multiplier setting. If a Weight ratio is displayed, the SG's of the 2 material entries (Advanced Screen #2) is used for the calculation.

For example, if a 240:240 pump PR70F with the Variable Ratio Arm setting of 1.0 is dispensing in weight mode where the SG's of material A is 1.222 times higher than material B, the weight ratio will be 1.222 as illustrated below:

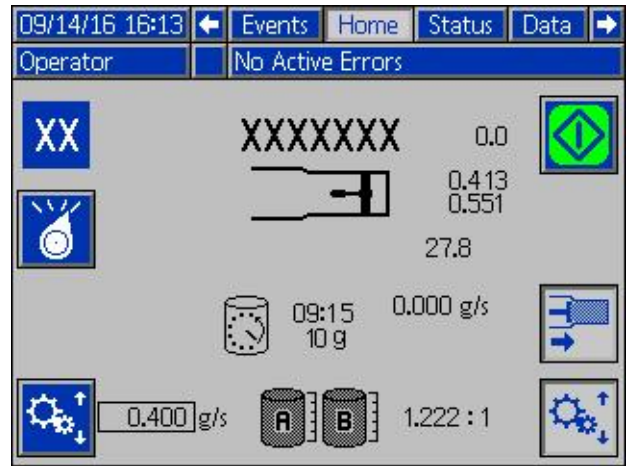

If the Variable Ratio Arm setting is adjusted to 1.25, as indicated above, the weight ratio now becomes 1.222 x 1.25, or 1.5275 as indicated below:

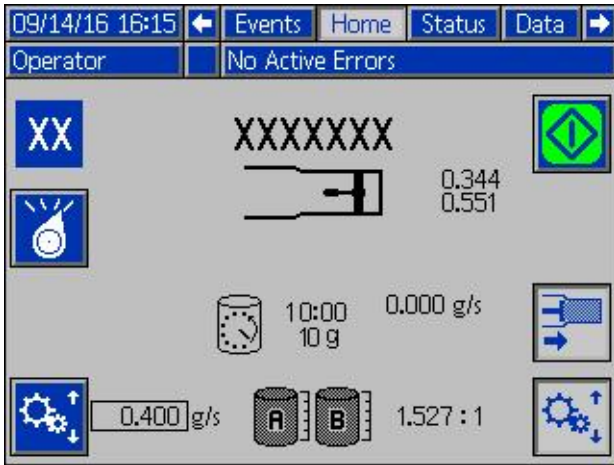

If it is desired to output the ratio in 100:xx format, simply change the **Ratio Format** control on the Advanced #5 Screen, as shown in the images below:

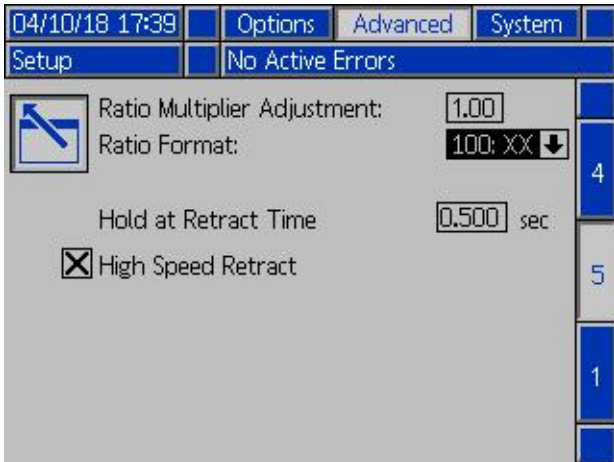

NOTE: Numbers may be rounded slightly.

Dispense Amount Accuracy

The PR70f is designed to provide a consistent dispense amount, typically within 1% of the shot amount and flow rate. The dispense amount is calculated using the pump reversing positions based on the pump sizes and SG information you enter, as referred to in **Pump Size, SG, and Flow Mode** on page 28. The following procedure can help to further ensure accuracy by calibrating the dispense amount to be equal to the actual amount.

This procedure is optional and not necessary for the PR70f to operate.

1. At the Home screen, with the machine in constant

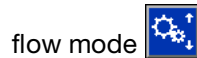



flow mode, enter the flow rate to which the dispense amount is to be calibrated. See **Home Screen Features** on page 23 for information about setting the flow rate.

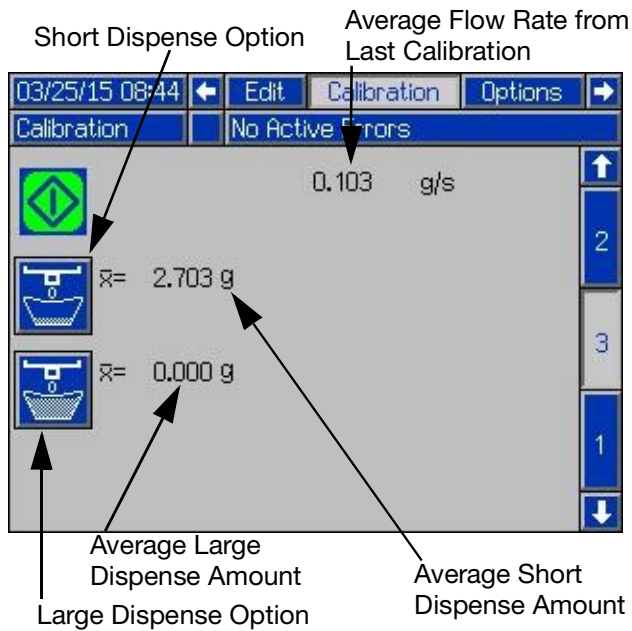

- Press  to access Setup mode. Use the directional keypad to navigate to Calibration screen 3.

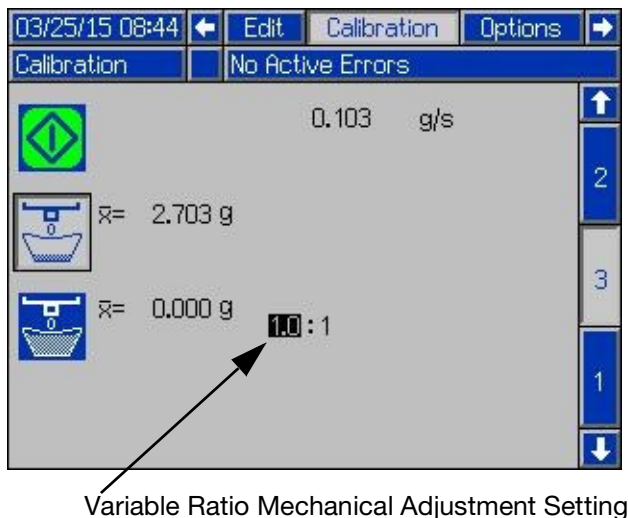





- Press the short dispense  key.
- The display prompts you to enter the variable ratio mechanical adjustment setting.



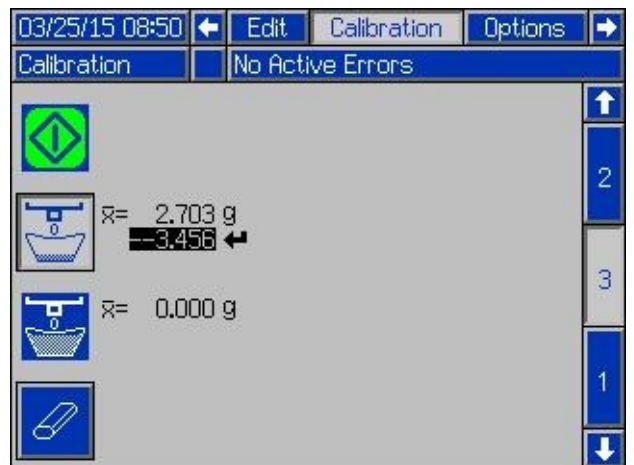

- Press  to accept the entry.

- After you enter 1.0, the  key becomes enabled and flashes. Tare an empty container on an accurate gram scale. Place the container under the dispense valve to catch the mixed material.
- Press the  key to perform a short dispense shot.
- When the dispense is completed, weigh the container and material and enter the material weight in the highlighted field using the numeric keypad.
- Press  to accept the change.





- Repeat steps 6-9 as many times as necessary to obtain a good short dispense average amount. After each entry, the new average dispense amount is displayed in the average short dispense amount field. Typically, this should only require 3 or 4 dispenses.
- After a reasonable average is obtained, press the  key or  to exit the short dispense calibration option.
- Select the long dispense  key.
- After you select the long dispense key, the  key becomes enabled and flashes. Tare an empty container on an accurate gram scale. Place the container under the dispense valve to catch the mixed material.

Operation

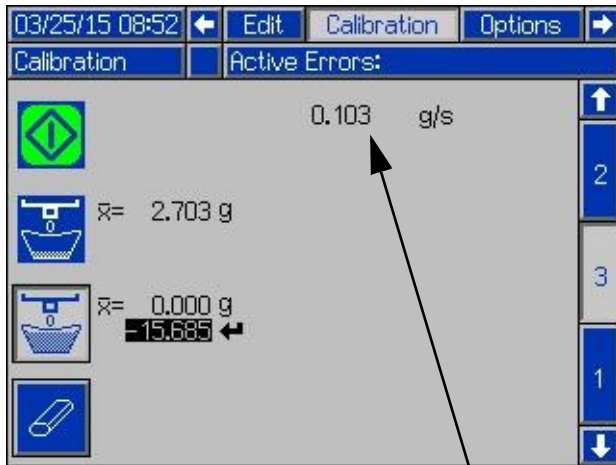
- Press the  key to perform a long dispense shot.
- When the dispense is completed, weigh the container and material and enter the material weight in the highlighted field using the numeric keypad.
- Press  to accept the change.



Average Flow Rate

- Repeat steps 13-16 as many times as necessary to obtain a good long dispense average amount. After each entry, the new average dispense amount is displayed in the average long dispense amount field.
- After a reasonable average is obtained, press the  key or  to exit the long dispense calibration option.

After completion, the screen displays the average flow rate for the calibration process. The PR70f provides accurate requested dispense amounts as long as the dispense rate is near the flow rate displayed.

Shot amount accuracy may be sacrificed if a dispense deviates much from the displayed flow rate. This would be especially true for faster flow rates that are greater than 1/10 of the maximum flow capacity of the machine. (Refer to tables 3.1-3.3 in **Appendix C - Product Pump Selection Guide** on page 93.)

If a dispense deviates from the displayed flow rate, recalibrate as necessary.

System Data

The screenshot shows a control panel interface with a menu bar at the top containing '03/05/15 16:24', 'Advanced', 'System', and 'Manual'. Below the menu bar, there are two tabs: 'Data' and 'No Active Errors'. The main display area shows 'Current Machine Cycles: 23941' and 'Total Machine Cycles: 40668'. Below this is a table with two columns: 'Component' and 'Software Version'. The table lists several components and their software versions. To the right of the table, there are arrows pointing to specific rows: 'ADM' points to the 'Advanced Display Module' row, 'Fluid Control Modules' points to the 'Fluid Control Module 1' and 'Fluid Control Module 2' rows, 'Zone Temperature Control Modules' points to the 'Temperature Control Module Z1', 'Z2', 'Z3', and 'Z4' rows, and 'USB' points to the 'USB Configuration' row.

Component	Software Version
Advanced Display Module	U82060 1.05.093
Fluid Control Module 1	U82058 1.03.006
Fluid Control Module 2	----- 0.00.000
Temperature Control Module Z1	----- 0.00.000
Temperature Control Module Z2	----- 0.00.000
Temperature Control Module Z3	----- 0.00.000
Temperature Control Module Z4	----- 0.00.000
USB Configuration	U82062 1.03.002

The System Data screen allows you to reset the current machine cycles and displays the software versions for the system components.

Software Version

The software version will read "0.00.000" if the component cannot be seen by the ADM. This is the result of the component not being installed or a communication error.

Machine Cycles

A machine cycle is one full extension and retraction of the machine piston. The Current Machine Cycles counter is resettable and the Total Machine Cycles counter is the number of cycles since the ADM was installed. Reprogramming the ADM does not reset the Total Machine Cycles counter.

Reset the Current Machine Cycles Counter

1. At the Home screen, press to access Setup mode. Use the directional keypad to navigate to the System Data screen.
2. Press the key to highlight the Current Machine Cycles counter.
3. Press the () to reset the Current Machine Cycles counter.
4. Press the to accept the reset and exit the screen.

Manual Overrides

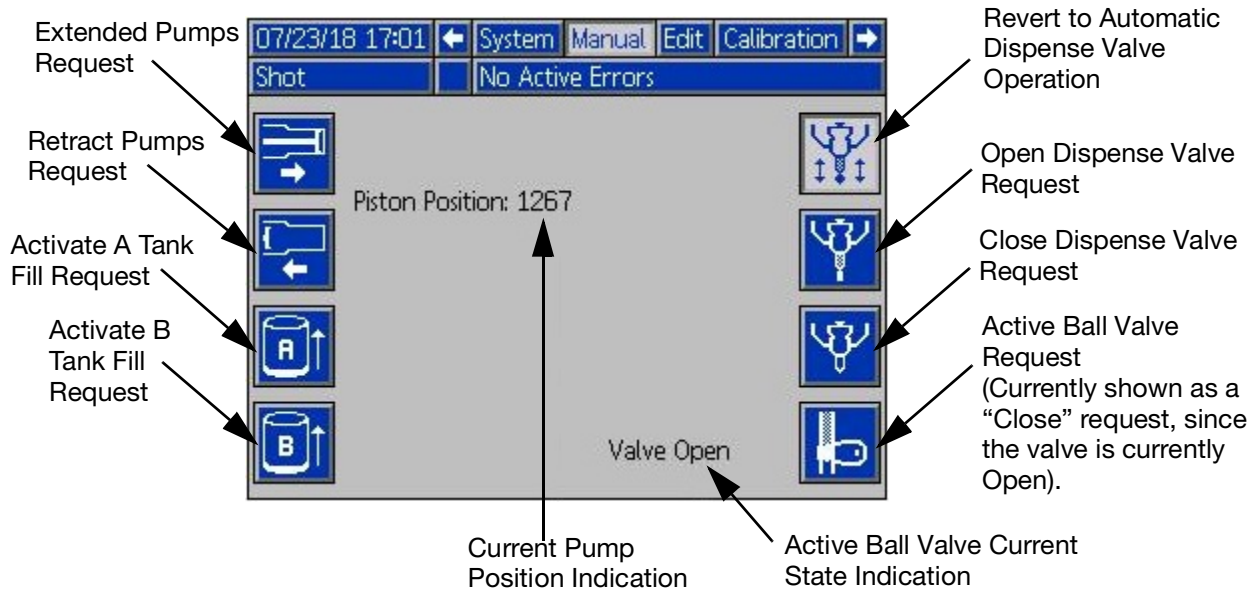

The Manual screen overrides the control of some machine actions. This can be useful for troubleshooting. To perform any of the available machine actions shown, press the corresponding soft key.

Some of soft key options will not be displayed, if the corresponding feature is not activated. For example, if the tank refill options are configured to "disabled", the Tank Fill Request options will not be shown. Similarly, if the "Active Check Valve Installed" check box option is NOT selected, the bottom right soft key request option will NOT be shown.

Status Run Screen

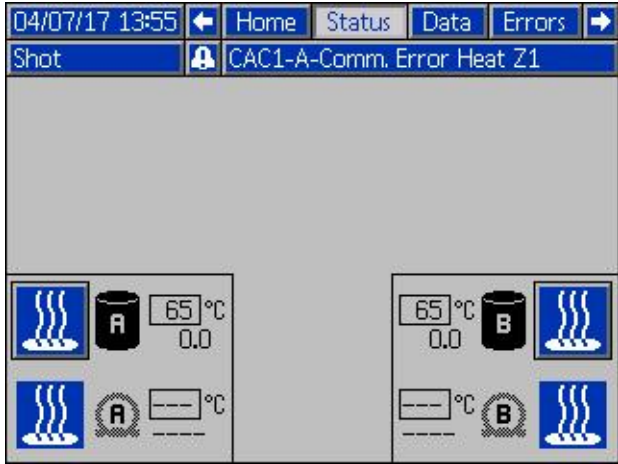

The status run screen (illustrated above), located to the left of the main “Home” screen, allows the user to view heat zone temperatures and turn the corresponding heat zones installed for the system On or Off. The zone set point temperature values are shown in a box, and the actual temperatures for the zones are shown below the set point values. If a zone is installed, the ICON for the soft key will appear three dimensional rather than flat.

As indicated in the illustration above, two zones are installed as tank heaters with identical set point values, and the zones are turned OFF. If the zone heaters were ON, the soft key ICONS would appear three dimensional, but would be inverse colors (blue areas would be white, and vice-versa). The hose heaters for the system illustrated are NOT installed, therefore their respective soft keys are disabled and their ICONS are flat.

To configure a temperature zone for the PR70F, refer to **Options Setup** on page 44, or navigate to the Setup Options #2 screen.



Shot Counters and Sequences

The data screens show the shot counters for all shots and shot sequences. Data screens 1-2 show the shot counters for all shots. Data screens 3-6 show the shot counters for sequences A through G, with two sequences shown per screen.

Reset Shot and Sequence Counters

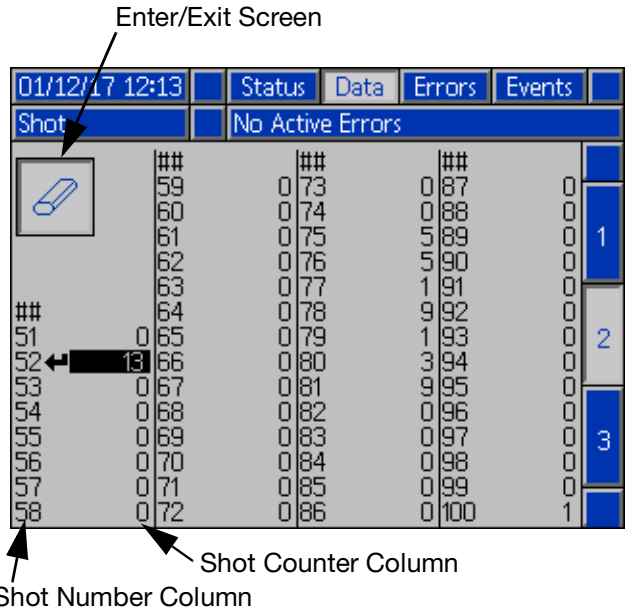
1. Use the directional keys to navigate to the correct Data Screen. See **ADM Screen Navigation Diagram** on page 21
2. Press the  key to enter the screen.
3. Use the directional keys to navigate to the counter to be reset.



4. Press the Enter button () to erase the counter.
5. Repeat steps 3 and 4 as necessary to erase other counters on the same screen.
6. Press the  key to exit the screen.

Error History

#	Date	Time	Code-Class-Event
1	10/06/15	16:42	Download to USB Complete
2	10/06/15	16:42	Download to USB In Process
3	10/06/15	16:38	Download to USB Complete
4	10/06/15	16:38	Download to USB In Process
5	10/06/15	15:20	Download to USB Complete
6	10/06/15	15:20	Download to USB In Process

Event History

#	Date	Time	Code-Class-Event
15	09/14/16	15:44:59	EJDX-R-System On
16	09/14/16	15:44:30	EHOX-R-System Off
17	09/14/16	15:43:47	EKDX-R-Shot 16.00g, 17.57sec, 0.974g/s
18	09/14/16	15:42:59	EKDX-R-Shot 15.00g, 18.47sec, 0.488g/s
19	09/14/16	15:42:22	EJDX-R-Aborted Early Shot 12.35g, 31.05sec, 0.488g/s
20	09/14/16	15:41:40	EKDX-R-Shot 10.00g, 31.49sec, 0.385g/s
21	09/14/16	15:40:40	EKDX-R-Shot 10.08g, 23.55sec, 0.541g/s

The Errors screens track all of the errors that have occurred on the machine. The latest error appears at the top of the list with date, time, and code-class-event information. For descriptions of error codes, see **Appendix A - Error Codes** on page 87.

The Events screens show a history of events for the machine with details of the event including date and time. The following is a list of events tracked on the Events screens.

- System Powered On
- System Powered Off
- Shot
- Purge Shot
- Stop Button Pressed
- System Calibrated
- Recirculation Mode entered

Bead Dispense Operation

The PR70f has features that allow dispensing beads of material. You can dispense beads using the ADM or by controlling the machine using the external control interface.

Pump Loading Feature

The auto-load pump feature extends the pumps to the metering tube entrance after every dispense and stalls to the pressure previously recorded while dispensing at the selected flow rate. This feature can be turned on at Advanced screen 4.

1. At the Home screen, press  to access Setup mode. Use the directional keypad to navigate to Advanced screen 4.

2. To make changes at this screen, press the  key to enter the screen.

3. Use the directional keypad to navigate to the Auto-Load Pump After Dispense check box.

4. Press  to check the box and turn on this feature.

5. Press the  key to exit the screen.

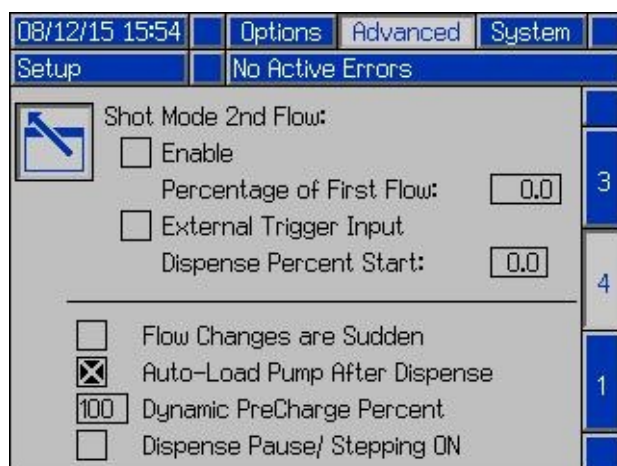

When the auto-load pump feature is turned on, the

 icon appears on the Home screen. At this point, the pump is not loaded.



To manually load the pump, press the key next to the

 icon. When the pump is loaded, the icon is

inverted and is displayed as . If the key is pressed again, the pumps will retract.

Dynamic Pre-charge Percent

When the pump loads (or pauses - see **Dispense Pause or Stepping** on page 64), you have the capability to alter the percentage of pressure recorded while dispensing at the selected flow rate. This feature is an effective method of dictating the thickness characteristics when starting the bead dispense (commonly called a “snake-head.”).

1. At the Home screen, press  to access Setup mode. Use the directional keypad to navigate to Advanced screen 4.

2. Press the  key to enter the screen.

3. Use the directional keypad to navigate to the Dynamic PreCharge Percent field. Use the numeric keypad to enter the percentage.

4. Press  to accept the change.

5. Press the  key to exit the screen.



How the Percent Setting Works

If a 1.000 g/s dispense records a pressure on the larger of the two pumps of 500 psi when it is dispensing at the 1.000 g/s flow rate, a pre-charge percent of 50 would load or pause the pump to a pressure of 250 psi. A 150 percent value would load or pause the pump to a pressure of 750 psi.

When loading, the machine extends the pumps until the required pressure on the larger of the two pumps (A or B) is reached. If the pumps are the same size, it defaults to the pressure on the A pump.

Dispense Pause or Stepping

The PR70f can pause an operator or shot mode dispense so it does not reload and leaves the pump in its current position. The pump pressure (stalling pressure) monitored during the previous dispense is maintained.

1. At the Home screen, press  to access Setup mode. Use the directional keypad to navigate to Advanced screen 4.

2. Press the  key to enter the screen.

3. Use the directional keypad to navigate to the Dispense Pause/Stepping ON check box.

4. Press  to “check” the box and turn on this feature.

5. Press the  key to exit the screen.



How the Dispense Pause Setting Works

A typical operator mode of 0.400 is displayed on the Home screen when dispensing, as shown below.



Typical Operator Mode

When the Dispense Pause/Stepping feature is turned

on and the dispense is terminated by pressing the  key or using the machine’s foot switch, the pump remains in the position it is in when the dispense is terminated.

The pump pressure is based on the pressure recorded during the dispense and the dynamic pre-charge percentage that was entered.

At this point, the Home screen appears similar to the example below.



If you continue the dispense by pressing the  key, the pump extends from the position where it was paused. This is referred to as dispense stepping.

To completely reload the pumps prior to dispensing,

press the  key or activate the Interrupt-Cancel line from the external control. See **External Control Interface Setup** on page 67. When the pumps are completely reloaded, the Home screen is similar to this example.

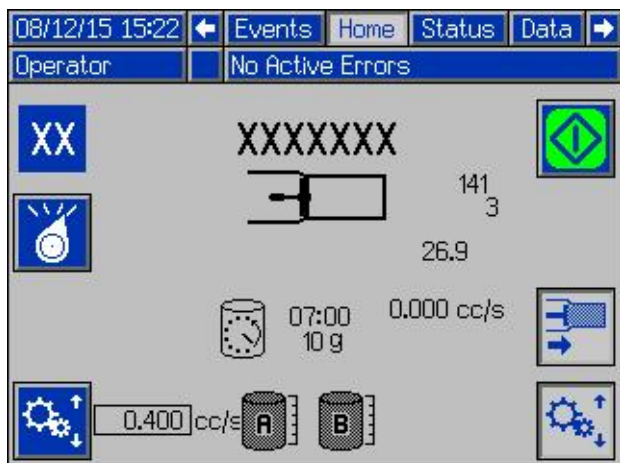

Bead Thickness Changes

There are two options available for changing the bead thickness or flow rates to create thicker or thinner beads: the ADM or external control interface.



When using the ADM, press the  key in the lower left side of the Home screen and enter a new value.

For the External control interface, activate the correct SHOT SEL-BIT 0 lines as described in the section **Flow Change During Active Operator Mode Dispense** on page 38.

Either method allows you to change the flow rate when the machine is dispensing or idle.

Flow Rate Changes Sudden or Gradual Option

When making flow rate changes during an active dispense, you have the option of changing the flow rate quickly or gradually. This feature is helpful when determining thick to thin or thin to thick bead transitions.

1. At the Home screen, press  to access Setup mode. Use the directional keypad to navigate to Advanced screen 4.
2. Press the  key to enter the screen.
3. Use the directional keypad to navigate to the Flow Changes are Sudden check box.
4. Press  to check the box and turn on this feature.



5. Press the  key to exit the screen.

If the Flow Changes are Sudden feature is not selected, flow rate changes will be gradual, requiring some time to react. How you configure this is based on your specific application and the need for faster or slower changes.

External Control Interface Setup

Connector #2

NOTE: Connector #2 is for use with systems with an Advanced Display Module only.

NOTE: View shown is looking at pins on end of cable.

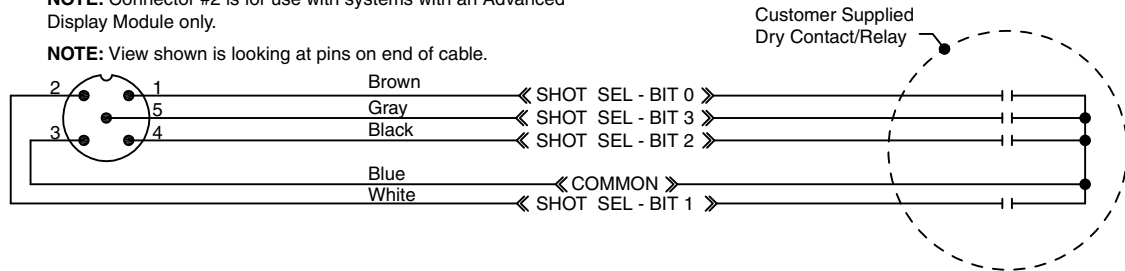

Connector #1

NOTE: Connector #1 is for use with all systems.

NOTE: View shown is looking at pins on end of cable.

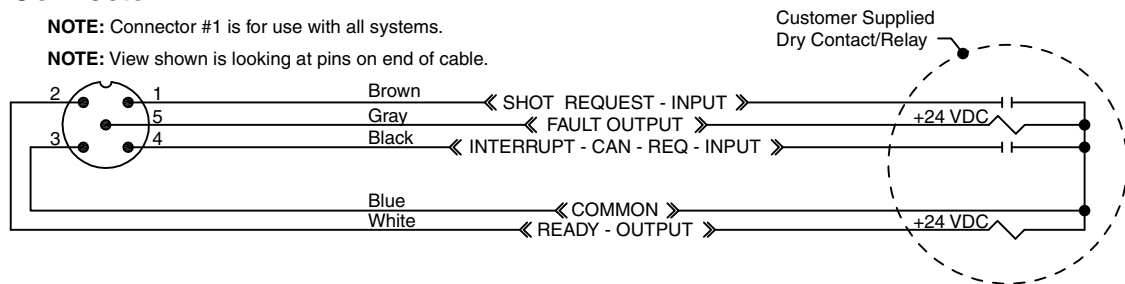

FIG. 15: External Control Interface Electrical Diagram

The external control interface allows an external machine to control the PR70f. The external machine can use Connector #1 to send dispense requests and abort commands. Also, Connector #1 indicates to the external machine whether the PR70f is ready to dispense. Connector #2 is used to select a shot number. See FIG. 16 for the location of the connectors on the PR70f.

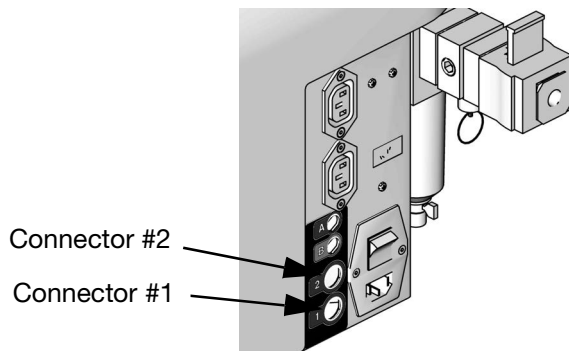

FIG. 16: External Control Connectors

Ready-Output Status Line

The Ready-Output status line (“READY-OUTPUT” in FIG. 15, Connector #1, Pin #2) is a signal provided to the external control. The line indicates whether a shot or dispense request will be accepted by the machine. The output of the Ready-Output status line is a “high” +24 VDC signal when the system is ready to dispense. The output is a “low” +15 VDC signal when the system is not ready to dispense. See FIG. 17 on page 71 for a sample timing diagram.

The following conditions will make the machine not ready to accept a dispense request.

- Dispensing in progress.
- User is programming the display module.
- Active error code that has not been acknowledged.
- Auto-Sequencing in progress.
- System is NOT in dispensing mode (Disable mode).
- The pumps are loading (“Auto-Load Pump After Dispense” turned ON).
- The system is starting up (ADM Splash screen active).
- The Interrupt-Cancel control line is active.
- When in shot mode and the “Auto-Load Pump After Dispense Feature” is OFF, if a shot is selected which is less than the minimum amount specified in tables 2.1 – 2.3, the ready line will be NOT ready.

For bead dispense applications where the machine is configured to “Auto-Load Pump After Dispense” (Advanced #4 screen), the Ready-Output Status Line will indicate “NOT Ready” if the pump is in the retract position (pumps NOT loaded). However, if the ready line is NOT ready due to this condition, the PR70F will accept a dispense request, assuming the dispense amount selected is greater than the minimum amount or the machine is in operator mode. This rule applies to PR70F system software versions 1.01.010 or higher.

Fault-Output Status Line

The Fault-Output status line (“FAULT-OUTPUT” in FIG. 12, Connector #1, Pin #5) indicates whether there is an active error. Active errors typically stop system operation. After using the ADM to acknowledge the error, normal operation is allowed.

The output of the Fault-Output status line is a “high” +24 VDC signal when an active error exists. The output is a “low” +15 VDC signal when there is not an active error. See FIG. 14 on page 46 for a sample timing diagram.

Dispense Request Line

The Dispense Request line (“Shot Request” in FIG. 15, Connector #1, Pin #1) is used to request a shot. The Dispense Request line operates the same as the

machine foot switch and the  key. When not in Operator mode and with a “high” Ready-Output signal, generate a short active Dispense Request signal to request a shot to begin. During dispensing, generate a short active signal in the Dispense Request line to abort the shot.

To generate an active Dispense Request signal, the external control needs to ground the Dispense Request line to the Return line (Connector #1, Pin #3) for 0.175 seconds to create a “low” signal. Remove the line from the Return line to end the active signal. See FIG. 17 on page 71 for a sample timing diagram.

If the active signal is generated when the system is in programming mode or generating an error code, the shot request is ignored.

If the active signal is sent during execution of a pause when in Auto-Sequencing, the machine aborts the pause timer and begins dispensing the next shot in the sequence.

If the active signal is sent during execution of a shot in a sequence, the machine aborts the shot and increments to the next shot in the sequence after the pistons fully retract. If the sequence is in auto-sequencing, the sequence pause timer then begins.

If Operator (Manual) mode is selected, the machine dispenses while the active signal is sent. When the active signal stops, the machine stops dispensing. If the piston Auto-Retract option is enabled on the System Options screen, the piston retracts when the machine stops dispensing. See FIG. 15 on page 67. If the Piston Auto-Retract is disabled, the machine stops dispensing and stalls the pumps against the dispense valve. If the pump is more than 80% into the metering tube, it automatically retracts regardless of whether Piston Auto-Retract is enabled.

Interrupt - Cancel Line

The Interrupt – Cancel line (INTERRUPT – CAN.INPUT” in FIG. 15 connector #1, pin #4) is used to abort a dispense, reset a sequence, reload the pump, retract the pump, or disable the machine completely.

To generate an active Interrupt – Cancel signal, the external control needs to ground the line to the signal return line for 0.175 seconds (shot pins #4 to #3 on connector #1). Remove the line from the return pin to end the active signal. Continuously creating an active signal will disable the machine for the duration of the time the line is active.

If the machine receives an active signal during an active dispense, the machine will abort the dispense. If received during an active sequence, the sequence will be reset to the sequence first position.

The active signal can also be used to reload or retract the pumps when the “**Auto-Load Pump After Dispense**” feature is active (refer to the **Bead Dispense Operation** section on page 63). If the machine is idle, an active signal will reload the pumps if they are retracted or in a paused state. If the pumps are already fully loaded, an active signal will retract the pumps, unless the “**ReLoad Only on INTERRUPT-CAN**” feature is turned on, where it will command the pumps to re-load again.

Shot Number Select, New Flow Lines

The external control interface has four lines used to select a shot number (“SHOT - SEL - BIT” lines in FIG. 12, Connector #2, Pins #1, 2, 4, 5). The default for each line is a “high” +24 VDC output. To select a shot, the external control needs to ground a certain combination of lines to the Return line (Connector #2, Pin #3) for at least 0.100 seconds to create a “low” signal for each line. Each combination refers to one shot number from Shot #1 to Shot #15. If all lines are “high” the shot selected on the display module is used. See the following table. See FIG. 14 on page 46 for a sample timing diagram.

For system software versions 1.06.007 or later, the Shot Number Selection lines cannot be used to select invalid or undefined shot numbers. Attempting to select an invalid or undefined shot number will be rejected.

Shot Number Selected	SHOT - SEL - BIT0 (Conn. #2, Pin #1)	SHOT - SEL - BIT1 (Conn. #2, Pin #2)	SHOT - SEL - BIT2 (Conn. #2, Pin #4)	SHOT - SEL - BIT3 (Conn. #2, Pin #5)
None / Display Module selection.	High	High	High	High
1	Low	High	High	High
2	High	Low	High	High
3	Low	Low	High	High
4	High	High	Low	High
5	Low	High	Low	High
6	High	Low	Low	High
7	Low	Low	Low	High
8	High	High	High	Low
9	Low	High	High	Low
10	High	Low	High	Low
11	Low	Low	High	Low
12	High	High	Low	Low
13	Low	High	Low	Low
14	High	Low	Low	Low
15	Low	Low	Low	Low

When in operator mode, the “SHOT SEL-BIT 0” line can be used to trigger a new flow set point if the External Trigger Input option on Advanced Screen #2 is checked. When the PR70f senses the line being pulled low during an active dispense, it will immediately command the pumps to the new flow rate value, based on the Percentage of First Flow amount entered on the same screen.

The shot number selections are also used to remotely select new flow rates for an active operator mode dispense when the Remote Flow Changes Enabled option is checked on the Advanced #2 setup screen. If an invalid or undefined shot number is selected, the flow selection is ignored.

If the Config. PLC Bit3 to Error Acknowledge option is checked on the Advanced 5 setup screen, the user will only be able to select 7 different shot recipes (when in shot mode) or flow rates (when in operator mode). If checked, the data from recipes 1 – 7 will be available. Refer to **Advanced Functions Setup** on page 50 for details.

External Control Interface Timing

The following timing diagram illustrates changing the shot number to Shot #13 then dispensing that shot.

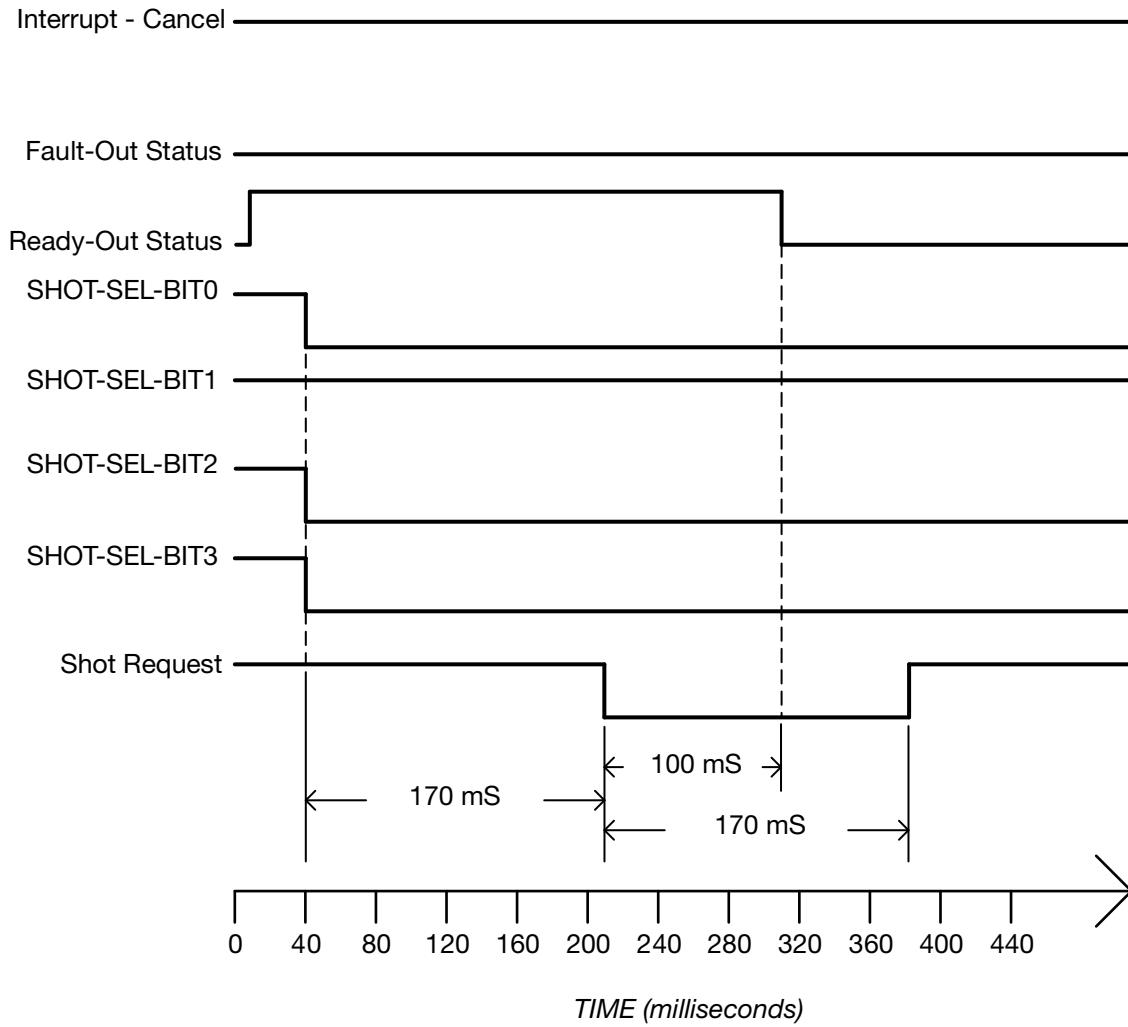

FIG. 17: External Control Timing Diagram

USB Data

USB Logs

During operation, the PR70f stores system and performance related information to memory in the form of log files. The PR70f maintains two log files: error logs and event logs. Follow the Download Procedure on this page to retrieve the log files.

Error Log

The error log file name is 1-ERROR.CSV and is stored in the DOWNLOAD folder.

The error log maintains a record of the last 1,000 errors.

- Error occurrence date
- Error occurrence time
- Error description

Event Log

The event log file name is 2-EVENT.CSV and is stored in the DOWNLOAD folder.

The event log maintains a record of the last 10,000 events.

An event entry is stored on the completion of an event. The following data, when applicable, is stored:

- Event date
- Event time
- Event description
- Shot Weight (grams)
- Dispense duration (seconds)
- Material A temperature
- Material B temperature
- Temperature units
- Dispense rate information
- Dispense pressure information

Download Procedure

1. Insert the USB flash drive into the USB port.

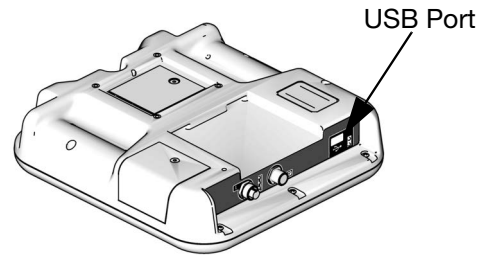

2. The menu bar and USB indicator lights indicate that the USB is downloading files. Wait for the USB activity to complete.
3. Remove the USB flash drive from the USB port.
4. Insert the USB flash drive into the USB port of the computer.
5. The USB flash drive window automatically opens. If it does not, open the USB flash drive from within Microsoft® Windows® Explorer.
6. Open the Graco folder.
7. Open the system folder. If downloading data from more than one system, there will be more than one folder. Each folder is labeled with the corresponding serial number of the ADM (The serial number is on the back of the ADM).
8. Open the DOWNLOAD folder.
9. Open the DATA folder labeled with the highest number. The highest number indicates the most recent data download.
10. Open the log file. Log files open in Microsoft Excel® by default as long as the program is installed. However, they can also be opened in any text editor or Microsoft Word.

NOTE: All USB logs are saved in Unicode (UTF-16) format. If opening the log file in Microsoft Word, select Unicode encoding.



Pressure Relief Procedure



The PR70f equipment stays pressurized until pressure is manually relieved. To help prevent serious injury from pressurized fluid, such as skin injection and moving parts, follow the **Pressure Relief Procedure** before cleaning, checking, or servicing the equipment.



Follow the Pressure Relief Procedure whenever you see this symbol.

1. Place a waste container below the dispense valve.
2. At the Home screen, press  to access Setup mode. Use the directional keypad to navigate to the Manual screen. See **ADM Screen Navigation Diagram** on page 21.
3. Press the Open Dispense Valve  key on the Manual screen to relieve chemical pressure.
4. Press the Machine Disable Mode  key.
5. Press down the system air pressure relief switch to stop air supply and to vent air pressure in the machine. It is the yellow tab at the rear of the machine (see FIG. 1 on page 15). The hole in the tab should be visible.
6. If necessary, run a lock through the hole to lock the tab in place. This prevents the system air pressure from being inadvertently enabled.

Shutdown



If the machine is to remain idle for an extended period of time, perform the following steps.

1. Place a waste container below the dispense valve.
2. If installed, remove the static mixer from the end of the dispense valve.
3. Place a container below the dispense valve and activate a small shot to flush mixed material out of the valve.
4. Relieve pressure. See the **Pressure Relief Procedure** on this page.
5. With a clean rag and cotton swabs, clean the end of the dispense valve.
6. Install the nightcap on the dispense valve.

Parts

NOTE: See Feed Systems manual for feed system parts. See **Related Manuals** on page 3.

Fixed Ratio Base, LC4000, LC4001

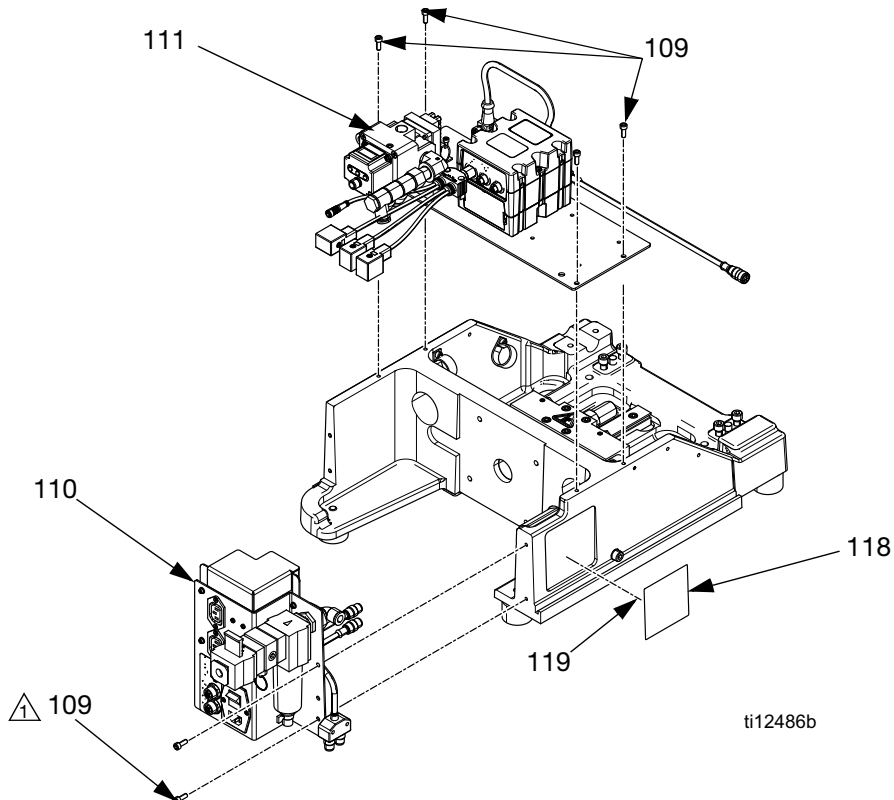
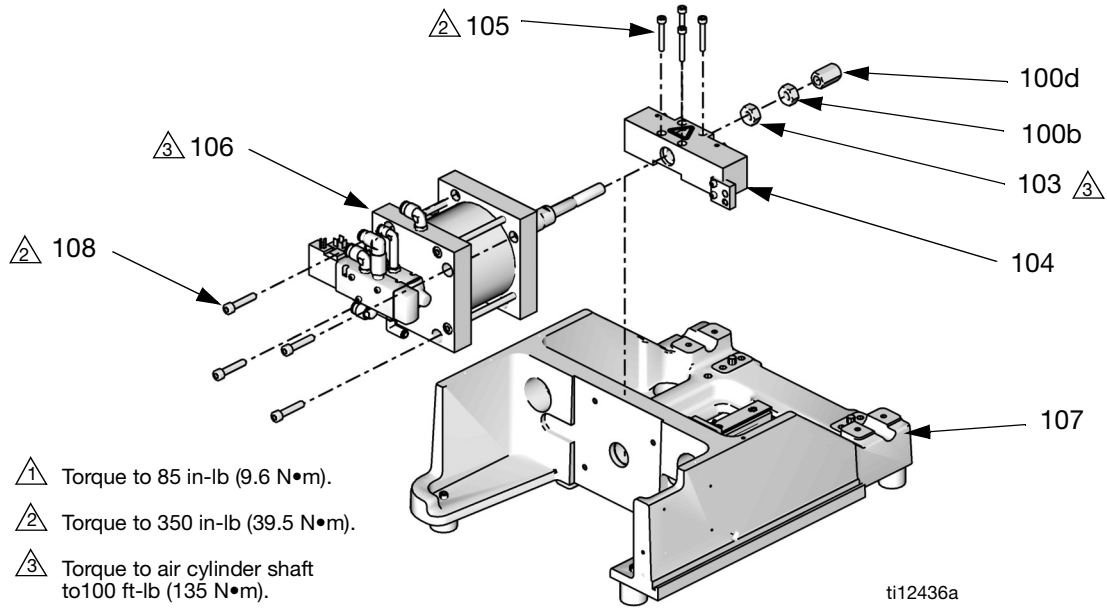

Fig. 18

Fixed Ratio Base, continued

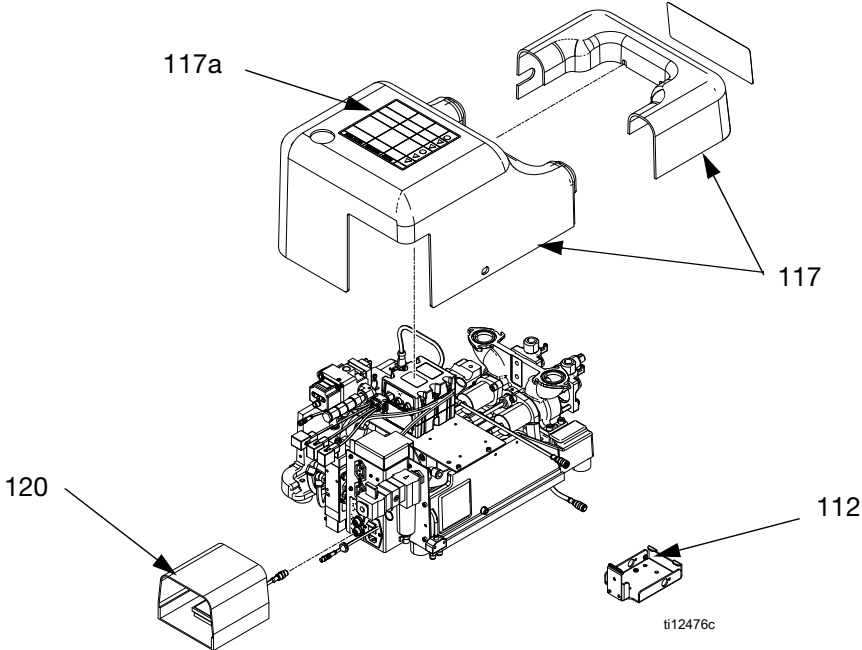
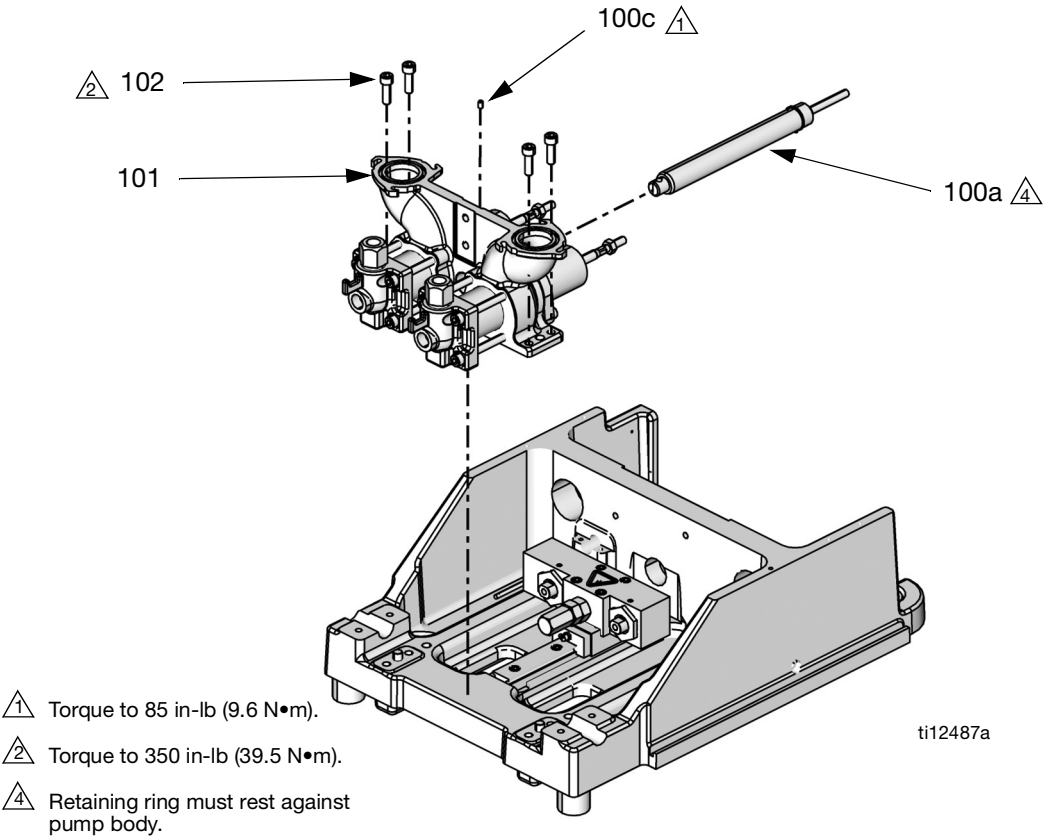

FIG. 19

Parts

Ref	Part	Description	Qty
100a	120920	SHOCK ABSORB, adjustable (models LC0263 and LC0265 only)	1
100b	120919	NUT, hex (models LC0263 and LC0265 only)	1
100c	111260	SCREW, set, cup point (models LC0263 and LC0265 only)	1
100d	15K816	CAP, adjustment, Hydracheck (models LC0263 and LC0265 only)	1
101	LC0112	PUMP, sub-assembly	1
102	120913	SCREW	4
103	120919	NUT, hex	1
104	LC0107	BLOCK, assembly, drive	1
105	121166	SCREW	4
106	LC0110	CYLINDER, air, sub-assembly, 3.0 in. (models LC0262 and LC0263 only)	1
	LC0111	CYLINDER, air, sub-assembly, 4.5 in. (models LC0264 and LC0265 only.)	1
107	LC0290	FRAME, sub, assembly	1
108	121167	SCREW	4
109	120885	SCREW	6
110	LC0239	BRACKET, incoming power, sub-assy	1
111	LC4004	BRACKET, controls, assembly	1
112	255235	BRACKET, mounting, assembly	1
114	* 121597	CABLE, CAN, 90 female / 90 female	1
115	* 61/2906-BK/11	TUBE, air, 3/8 in. OD	2
116	* 61/2904-BK/11	TUBE, air, 1/4 in. OD	2
117	LC0308	SHIELD, assembly	1
117a	▲15M511	LABEL, shield	1
118	84/0001-6/11	TAG, ID	1
119	96/0235/98	SCREW, drive, type U, #2 X 3/16 stainless steel	4
120	255244	SWITCH, foot, assembly	1

* Not shown.

▲Replacement Danger and Warning labels, tags, and cards are available at no cost.

Variable Ratio Base, LC4002, LC4003

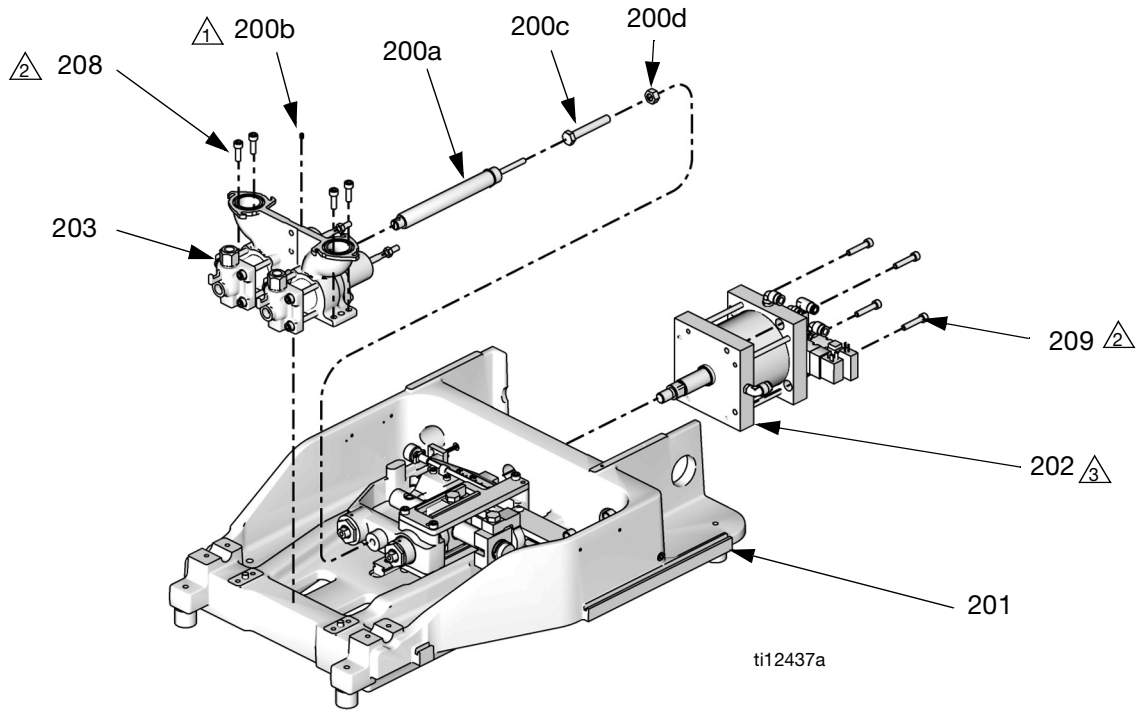

- △1 Torque to 85 in-lb (9.6 N•m).
- △2 Torque to 350 in-lb (39.5 N•m).
- △3 Torque to air cylinder shaft to 100 ft-lb (135 N•m).

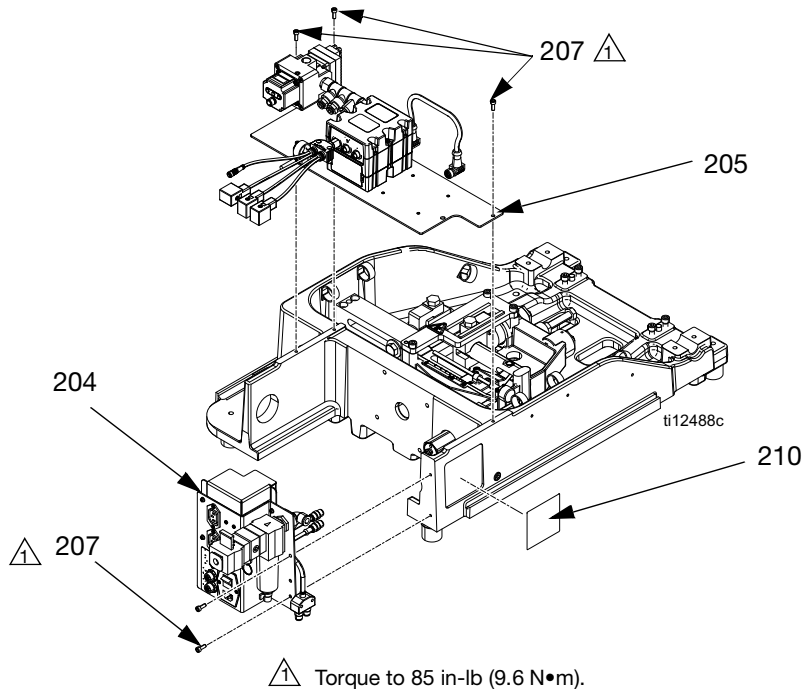

FIG. 20

Variable Ratio Base continued

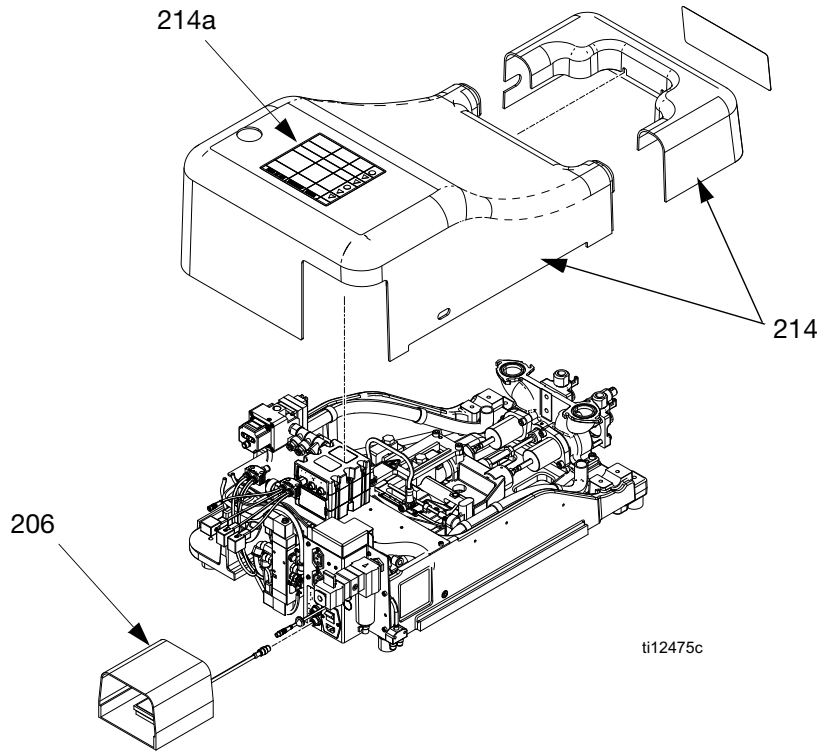

FIG. 21

Ref	Part	Description	Qty	Ref	Part	Description	Qty
200a	120920	SHOCK ABSORB, adjustable (models LC0243 and LC0245 only)	1	213	61/2906-BK/1 1	HOSE, 0.245ID x 0.375 OD, PU, 95 DUR	1
200b	111260	SCREW, set, cup point (models LC0243 and LC0245 only)	1	214	LC0246	SHIELD, assembly	1
200c	121589	SCREW, hex head cap, M12 x 1.75, 80 mm long (models LC0243 and LC0245 only)	1	214a	▲15M511	LABEL, shield	1
200d	107539	NUT, hex (models LC0243 and LC0245 only)	1	215	* 124002	PROTECTOR, wire, corrugated, 5/8 in. ID	8
201	LC0232	FRAME, sub-assembly	1		* 124002	PROTECTOR, wire, corrugated, 5/8 in. ID	5
202	LC0230	CYLINDER, air, 3.0 in. diameter (models LC0242 and LC0243 only)	1				
	LC0231	CYLINDER, air, 4.5 in. diameter (models LC0244 and LC0245 only)	1				
203	LC0112	PUMP, sub-assembly	1				
204	LC0239	BRACKET, incoming power, sub-assy	1				
205	LC4007	BRACKET, control, sub-assembly	1				
206	255244	SWITCH, foot, assembly	1				
207	120885	SCREW	5				
208	120913	SCREW	4				
209	121167	SCREW	4				
210	16D782	LABEL	1				
212	61/2904-BK/1 1	HOSE, 0.160 ID x 0.250 OD, PU, 95 DUR	1				

* Not shown.

▲ Replacement Danger and Warning labels, tags, and cards are available at no cost.

Control Bracket (Fixed), LC4004

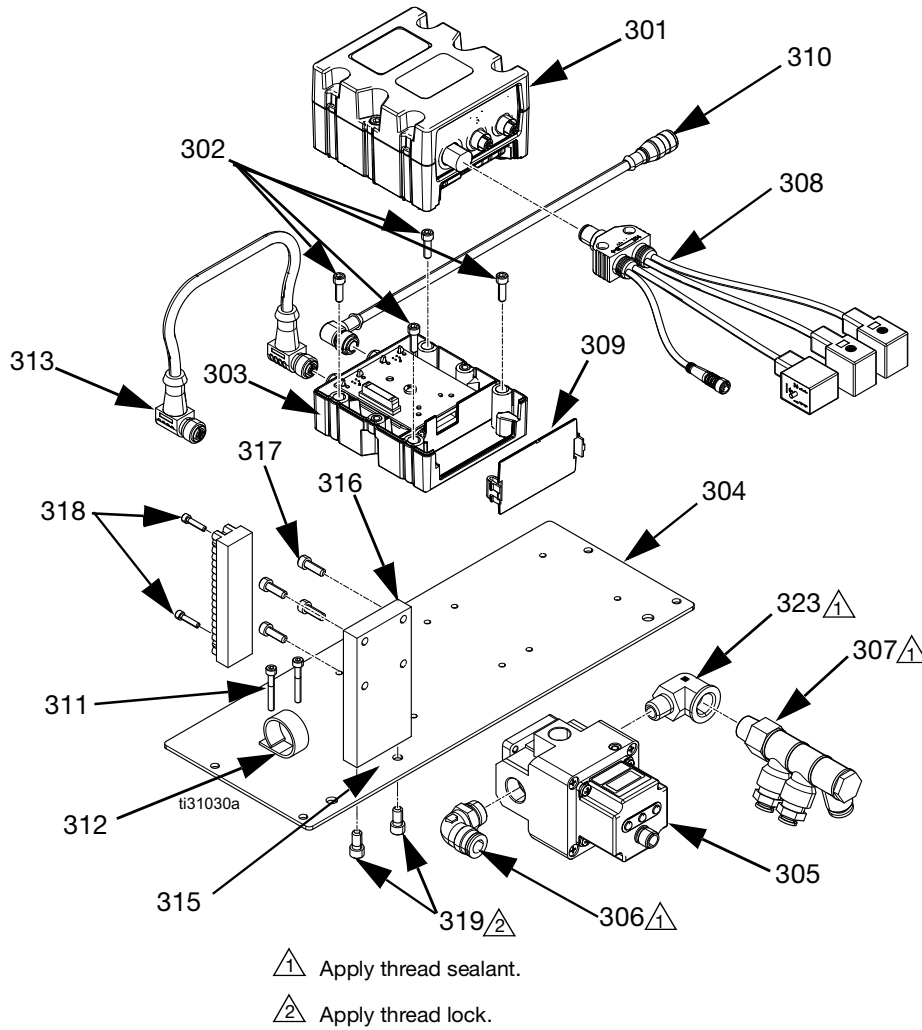

Ref	Part	Description	Qty	Ref	Part	Description	Qty
301	U82057	MODULE, assy, cube	1	317	117126	SCREW, shcs	4
302	113003	SCREW, shc, sst	4	318	96/0340/	SCREW, shc	2
303	289697	MODULE, gca, cube, base	1	99			
304	U60656	BRACKET	1	319	551903	SCREW, cap, sch	2
305	24U821	REGULATOR, electro/pneumatic	1	320	*U70851	CABLE, M12 x bare leads	1
306	121019	FITTING, elbow, male, swivel	1	321	*U70850	CABLE, M8 x bare leads	2
307	120954	MANIFOLD, inlet, banjo	1	322	*U70849	CABLE, M8 90 x bare leads	2
308	128538	CABLE, gca, PR70	1	323	94/0533/	FITTING, elbw, street	1
309	277674	ENCLOSURE, cube door	1	96			
310	121685	CABLE, can	1	324	*070269	SEALANT, anaerobic, blue	1
311	121860	SCREW, ss	2				
312	125030	STRAP, wire	1				
313	121597	CABLE, can	1				
314	*070408	SEALANT, pipe, sst	1				
315	U60657	BLOCK, regulator mount	1				
316	---	BLOCK, terminal	1				

* Not Shown

Control Bracket (Variable), LC4007

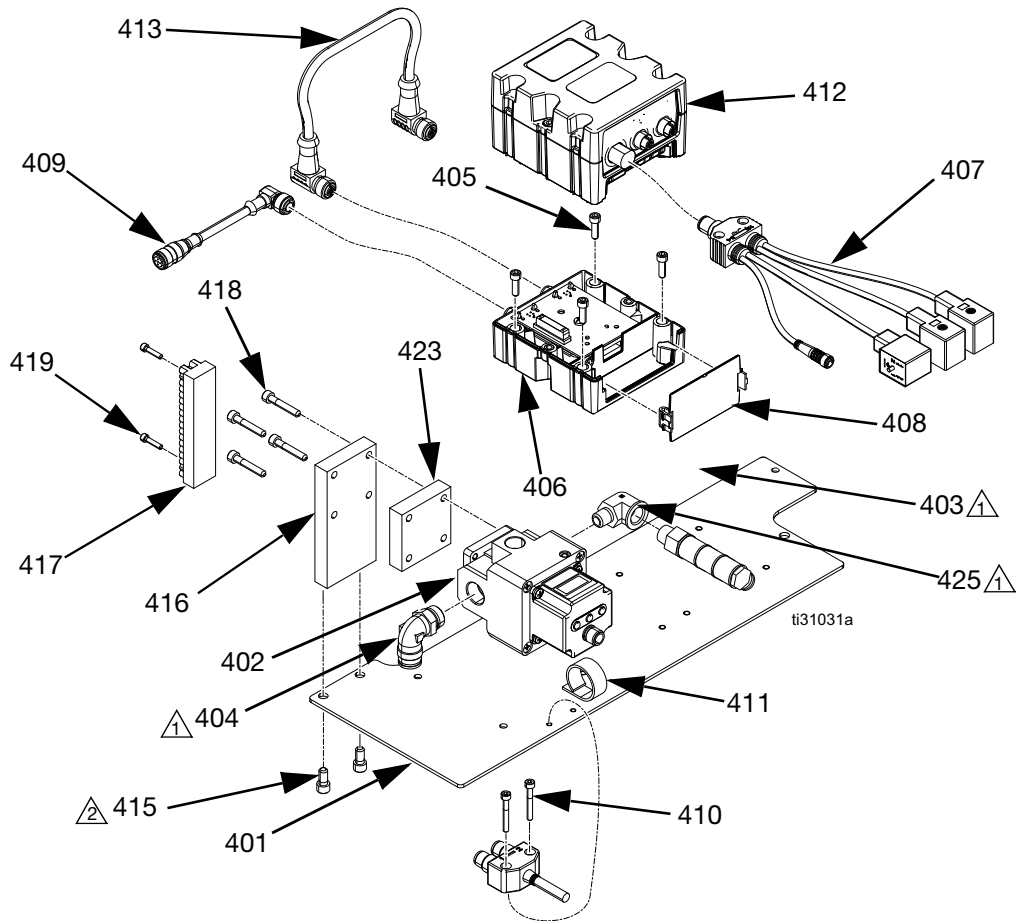

△ Apply thread sealant.

△ Apply thread lock.

Ref	Part	Description	Qty	Ref	Part	Description	Qty
401	U60809	BRACKET, control, mounting	1	417	---	BLOCK, terminal	1
402	24U821	REGULATOR, electro / pneumatic	1	418	121194	SCREW	4
403	120954	MANIFOLD, inlet, banjo	1	419	96/0340/	SCREW, shc	2
404	121019	FITTING, elbow, male, swivel	1	99			
405	113003	SCREW, shc	4	420	*U70851	CABLE, M12 x bare leads	1
406	289697	MODULE, gca, cube, base	1	421	*U70850	CABLE, M8 x bare leads	2
407	128538	CABLE, gca, PR70	1	422	*U70849	CABLE, M8 90 x bare leads	2
408	277674	ENCLOSURE, cube door	1	423	U60810	SPACER, regulator mount	1
409	121685	CABLE, can	1	424	94/0533/	FITTING, elbw, street	1
410	121860	SCREW	2	96			
411	125030	STRAP, wire	1	425	*070269	SEALANT, anaerobic, blue	1
412	U82057	MODULE, assy, cube	1				
413	121597	CABLE, can	1				
414	*070408	SEALANT, pipe, sst	1				
415	96/0162/	SCREW, shc	2				
	98						
416	U60657	BLOCK, regulator mount	1				

* Not Shown

Maintenance



Schedule

Action	Schedule	Procedure
Check Water/Air Separator	Daily before use	<ol style="list-style-type: none"> 1. Check water/air separator for water. 2. Open valve at base of water/air separator to purge water.
Check Desiccant Dryer (only installed if chemical is moisture sensitive)	Daily before use	<ol style="list-style-type: none"> 1. Check the color of the desiccant. 2. Replace as required.
Check Tanks	Daily before use	<ol style="list-style-type: none"> 1. Check material levels and refill as necessary. 2. Verify the material reservoirs are vented properly.
Check Dispensing Ratio	Daily before use or as required	See Pump Position Calibration on page 25. If ratio accuracy is critical to the application, perform ratio check procedure daily before use.
Clean Pump Shafts	Daily after shutdown	See Clean the Pump Shafts on this page.
Clean Dispense Valve	Daily	See Shutdown on page 73.
Lubricate Pneumatic Air Motor	Every 8 hours	See Lubricate the Pneumatic Air Motor on page 82.
Lubricate Pneumatic Air Motor 01/0368-1/11 Gear Box	Every 2 days Every 6 months (or 2500 operating hours)	See Lubricate the Gear Box of the Pneumatic Air Motor 01/0368-1/11 on page 82.
Flush Pneumatic Air Motor 82/0216/11	As required	See Flush the Pneumatic Air Motor 82/0216/11 on page 82.
Disassemble and Clean Dispense Valve	As required	See Disassemble and Clean the Dispense Valve on this page.
Upgrade Advanced Display Module and Fluid Control Module Software	As required	See Install the Upgrade Token on page 83.

Clean the Pump Shafts

1. Press down the air pressure relief switch at the left, rear of machine. See FIG. 1 on page 15.
2. Press the Machine Disable Mode  key.
3. Push the piston block to the fully retracted position.
4. Clean both pump shafts with solvent and lubricate them with a thin coat of appropriate assembly lubricant.

Disassemble and Clean the Dispense Valve

1. Relieve pressure. See the **Pressure Relief Procedure**, page 73.
2. Remove the dispense valve from the machine.
3. Dismantle the dispense valve. See the MD2 Dispense Valve Instructions and Parts Manual, 312185, referenced in **Related Manuals** on page 3.
4. Clean all parts.

- Lubricate all parts with a thin coat of appropriate assembly lubricant.
- Reassemble the dispense valve. See manual 312185 for details.
- Reinstall the dispense valve on the machine.

Flush the Pneumatic Air Motor 82/0216/11

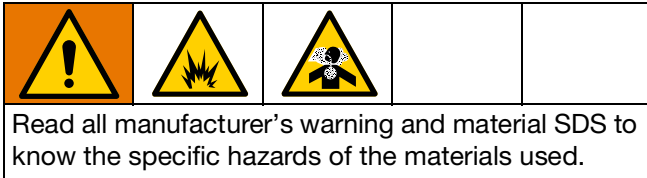

If the motor is sluggish or inefficient, flush it with a non-flammable solvent in a well ventilated area. The recommended solvent for air motors and lubricated pumps is Gast[®] Flushing Solvent (Part No. AH255 or AH255A) or Inhibisol[®] Safety Solvent.

- Disconnect the air line and muffler.
- Add several teaspoons of solvent or spray the solvent directly into the motor.
- Rotate the shaft by hand in both directions for a few minutes.
- Reconnect the air line, and slowly increase the air pressure until there is no trace of solvent in the exhaust air.
- Re-lubricate the motor with a squirt of light-weight oil in the chamber.

Lubricate the Pneumatic Air Motor

NOTICE

Not lubricating the air motor will cause motor failure.

If an air line lubricator is not installed, the air motor must manually be lubricated every eight hours. Lubricate the agitator air motor by placing 10-20 drops of SAE #10 light oil in the air inlet of the motor. Run the agitator for about 30 seconds.

Lubricate the Gear Box of the Pneumatic Air Motor 01/0368-1/11

NOTE: This section does not apply to pneumatic air motors 24J182 or 24J183.

Check the Oil Level

Perform the following procedure every two days.

- Remove the oil fill plug and check the oil level. The proper oil level is indicated on the outside of the gear box housing.
- If the oil level is low, add 140-weight SAE gear oil or a high-quality worm gear lubricant.
- Replace the fill plug and torque to 20 ft-lb (27 N•m).

NOTE: Gear box oil is easiest to drain immediately following motor operation while the oil is still warm.

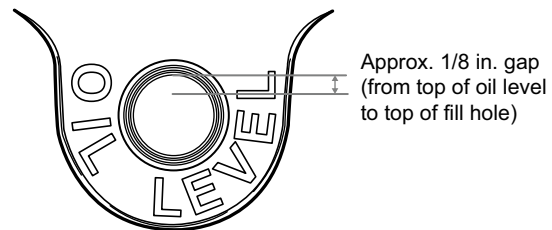

FIG. 22

NOTE: Do not overfill. Overfilling may cause oil to leak out of the vent cap on top of the gear box.

Replace the Oil

Perform the following procedure after the first 250 hours of operation. After that, perform it every six months or every 2500 operating hours.

- Remove the gear box and drain the oil.
- Refill the gear box with 140-weight SAE gear oil or a high-quality worm gear lubricant.
- Replace the fill plug and torque to 20 ft-lb (27 N•m).

NOTE: Replace gear oil more often if the environment causes the oil to become contaminated during use.

Install the Upgrade Token

This procedure applies to the Advanced Display Module (ADM) and Fluid Control Module (FCM).

1. Disconnect power to the module.
2. Remove the token access panel. See FIG. 16.

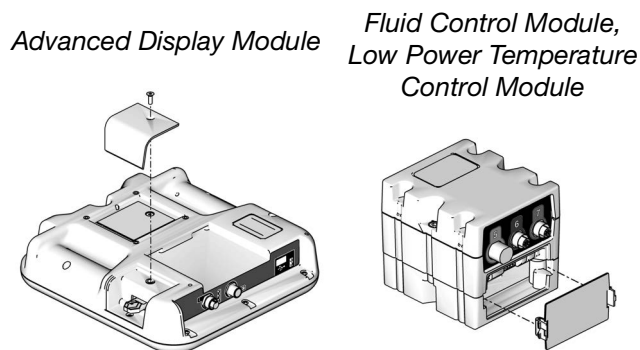

FIG. 23: Remove Access Panel

3. Insert and press the token firmly into the slot.



NOTE: There is no preferred orientation of the token.

4. Restore power to the module. The red LED flashes rapidly to signal that software is loading. When the red LED stops flashing, the software is done loading.
5. Disconnect power to the module.
6. Remove the token.
7. Replace the token access panel.
8. Restore the power to the module.
9. Repeat for each module that needs to be updated.
10. Verify the new software versions on the System Data screen. See **System Data** on page 59.

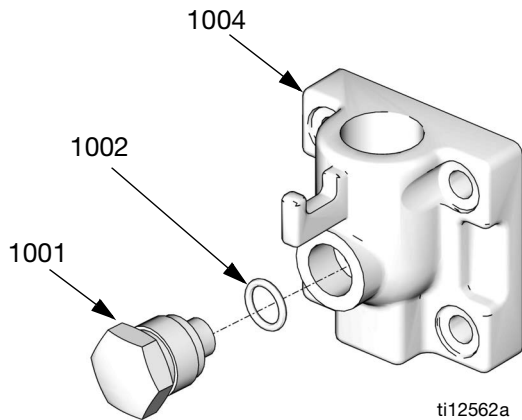
Piston Plug Installation



Ref	Part	Description	Qty
1001	15K815	PLUG, dummy, transducer	2
1002	111457	O-RING	2
1004	15K787	CAP, end, pump, machined	2

- Drain the pump.
 - If ball valves are installed**, close the ball valves then take several shots.
 - If ball valves are not installed**, empty the tanks. Perform shots repeatedly until no material comes out of the dispense valve.
- Relieve pressure. See **Pressure Relief Procedure**, page 73.
- Models with ADM:** To prevent machine movement, press the Machine Disable Mode key .
Models with SDM: To prevent machine movement, press the Red button .
- Use a wrench to remove the existing piston plug (1001) from the pump end cap (1004).
- Remove the existing o-ring (1002).
- Lubricate the new o-ring with a high temperature grease (part 115982) and install the lubricated o-ring into the end cap.
- Install pump plug (1001) into end cap (1004).
- Open the tank ball valves if installed.
- Fill tanks.
- Perform several shots to fill the pump with new material.

Pressure Transducer Installation

NOTE: The pressure transducers are designed to work with the hoses available in the PR70 configurator. If they are used with other hoses, unexpected alarms may occur.

- Follow steps 1 through 6 of **Piston Plug Installation** on this page.
- Remove shield locking screws (D) then remove shield (J).
- Install hex end of pressure transducer into end cap (1004).
- For A side pressure transducers**, install data cable end of pressure transducer into port #6 of Fluid Control Module #1. See FIG. 33, page 109.
For B side pressure transducers, install data cable end of pressure transducer into port #7 of Fluid Control Module #1. See FIG. 33, page 109.
- Install shield and shield locking screws.
- Follow steps 8 through 10 of **Piston Plug Installation** on this page.

Pressure Transducer, Assembly 257433

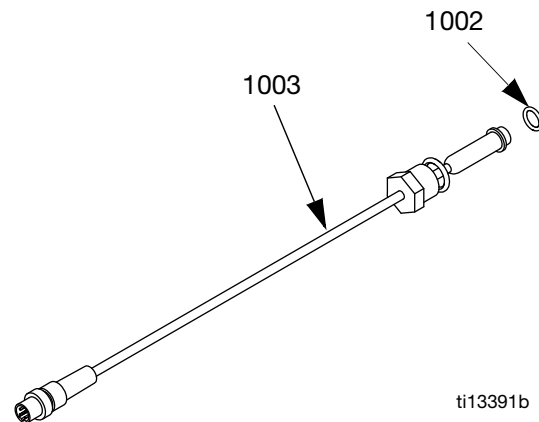

Ref	Part	Description	Qty
1003	16A093	SENSOR, pressure	2
1002	111457	O-RING	2

Troubleshooting



Before starting any troubleshooting procedures, perform the following procedures. See the PR70 and PR70v Repair and Parts Manual, 312760, referenced in **Related Manuals** on page 3 for detailed procedures.

1. Relieve pressure. See the **Pressure Relief Procedure** on page 73.

2. Disconnect AC power from the machine.
3. Allow the machine to cool if the machine has a heat control option.

Try the recommended solutions in the order given for each problem to avoid unnecessary repairs. Verify all circuit breakers, switches, and controls are properly set and wiring is correct.

Problem	Cause	Solution
Advanced Display Module completely dark	No power	Verify rear AC Power switch is ON.
	Fuse blown	Replace machine fuses.
	Loose connection	Tighten 5-pin cable on ADM.
	Bad display module	Replace Advanced Display Module.
No or incorrect amount of material dispensed from either side	Ball valve closed (if installed)	Open tank ball valve.
	Tank empty	Fill tank with material.
	Tank clogged	Verify no obstruction in the tank.
	Air in material	Prime the machine until the air is removed.
	Check valve malfunction	Remove; clean or replace check valve.
Piston stalled	Piston worn or broken	Remove and replace piston if worn.
	Input air reduced or removed	Reconnect input air line to machine. Increase air pressure regulator adjustment.
	Mixer blocked	Replace static mixer. Incorporate purge timer or decrease purge timer delay to prevent mixer blockage.
	Open Dispense Valve (ODV) adjustment too late	Readjust the ODV setting to occur sooner.
	Blocked check valve	Remove check valve; clean and replace.
Significant material leaking from pump rear seal	Air cylinder failure	Remove air cylinder and reinstall air cylinder parts as necessary.
	Pump shaft worn and/or shaft seal worn	Remove pump shaft assembly, and reinstall rear pump rebuild kit.

Problem	Cause	Solution
Material dispensed not correct weight	Specific gravity of one or more of the two materials has changed since calibration	Recalibrate machine.
	Machine air pressure has changed since calibration	Readjust air pressure regulator to value used when machine was calibrated, or recalibrate machine.
	Not enough material in one or more tanks	Check tank levels; fill and prime as necessary.
	Mixer has slight obstruction	Replace static mixer. Prime machine.
	Check valve malfunction	Remove check valve; clean or replace as necessary.
	Piston worn or broken	Replace piston.
Machine dispensing off ratio	One tank is empty	Check tank levels. Add material if necessary.
	Tank ball valve closed	Open tank ball valve. Prime machine.
	Machine out of phase	Re-phase machine.
	Check valve malfunction	Remove check valve; clean or replace as necessary.
	Piston worn or broken	Replace piston.
Pumps drawing material back from valve hose	Check valve stuck open	Remove check valve, clean or replace as necessary.

Appendix A - Error Codes

Code-Class-Event Shown on Errors Screen	Description	System Behavior Ref
050X-A-Improper System Cal	Improper Calibration	5
A401-A-Over Current Z1	Heater Over Current, Zone #1	7
A402-A-Over Current Z2	Heater Over Current, Zone #2	7
A403-A-Over Current Z3	Heater Over Current, Zone #3	7
A404-A-Over Current Z4	Heater Over Current, Zone #4	7
A4C1-A-Fan Over Current Z1	High Relay 2 Current, Zone #1	7
A4C2-A-Fan Over Current Z2	High Relay 2 Current, Zone #2	7
A4C3-A-Fan Over Current Z3	High Relay 2 Current, Zone #3	7
A4C4-A-Fan Over Current Z4	High Relay 2 Current, Zone #4	7
A701-A-Heater Fault Z1	Unexpected Heater Current, Zone #1	7
A702-A-Heater Fault Z2	Unexpected Heater Current, Zone #2	7
A703-A-Heater Fault Z3	Unexpected Heater Current, Zone #3	7
A704-A-Heater Fault Z4	Unexpected Heater Current, Zone #4	7
A7C1-A-Fan Output Fault Z1	Unexpected Relay 2 Current, Zone #1	7
A7C2-A-Fan Output Fault Z2	Unexpected Relay 2 Current, Zone #2	7
A7C3-A-Fan Output Fault Z3	Unexpected Relay 2 Current, Zone #3	7
A7C4-A-Fan Output Fault Z4	Unexpected Relay 2 Current, Zone #4	7
B10X-A-Small Shot Request	Less Than Minimum Shot Requested	5
CAC1-A-Comm. Error Heat Z1	Communication Error, Heat Zone #1	1
CAC2-A-Comm. Error Heat Z2	Communication Error, Heat Zone #2	1
CAC3-A-Comm. Error Heat Z3	Communication Error, Heat Zone #3	1
CAC4-A-Comm. Error Heat Z4	Communication Error, Heat Zone #4	1
CAC5-A-Comm. Error FCM 1	Communication Error, FCM3 #1	2
CAC6-A-Comm. Error FCM2	Communication Error, FCM3 #2	3
D1A1-D-Setpoint Not Reached	Machine can not reach or consistently maintain flow rate setpoint entered	8
DEFX-A-Piston Timeout	Piston Stroke Timeout	5
DJ0X-D-Linear Sensor Fault	Bad Linear Position Sensor	6

Code-Class-Event Shown on Errors Screen	Description	System Behavior Ref
F2DA-V-Flow Reduced High Pressure A	Dispense pressure during the pump extend process exceeded the "A or B Pump High Pressure Limit" setting on the Options #4 setup screen, and flow was reduced to lower the corresponding pump pressure.	Advisory only, generated after a dispense. Does not effect operation.
F2DB-V-Flow Reduced High Pressure B		
F6A-Flow Meter A Problem	Flow Meter A Problem, or bad connection between Fluid Control Module and Flow Meter A (Ratio Assurance Option Only).	6
F6B-Flow Meter B Problem	Flow Meter B Problem, or bad connection between Fluid Control Module and Flow Meter B (Ratio Assurance Option Only).	6
L0A0-R-A Manual Fill Instigated	A manual tank fill operation was started for the A (or B) tank.	This is a record level event which only generates a log (for the USB and Error screen). No pop-up window is generated.
L0B0-R-B Manual Fill Instigated		
L2AX-D-Low Level Tank A	Low Material Level, Tank A	6
L2BX-D-Low Level Tank B	Low Material Level, Tank B	6
L2FX-D-Low Level Tank A/B	Low Material Level, Both Tanks	6
L7A0-V-A Fill Aborted Before Done	The user has aborted a Manually or Automatically initiated fill operation before the fill operation was completed for the corresponding tank.	Advisory which logs the event. A pop-up window will be generated after the user aborts the fill process.
L7B0-V-B Fill Aborted Before Done		
L8AX-D-Refill Timeout A	Auto Refill Failed, A Side	6
L8AX-D-Refill Timeout B	Auto Refill Failed, B Side	6
P2AX-D-Low Pressure A	A Side Low Pressure, relative to the Low Pressure Setting on Options #4 screen.	6
P2BX-D-Low Pressure B	B Side Low Pressure, relative to the Low Pressure Setting on Options #4 screen.	6
P3AX-D-High Pressure A	A Side High Pressure, exceeding 3000 psi.	6
P3BX-D-High Pressure B	B Side High Pressure, exceeding 3000 psi.	6
P6AX-D-Pressure Fault A	Problem with A Side Piston Pressure Transducer or Transducer Connection	6

Code-Class-Event Shown on Errors Screen	Description	System Behavior Ref
P6BX-D-Pressure Fault B	Problem with B Side Piston Pressure Transducer or Transducer Connection	6
P6DX-D-Pressure Fault A/B	Problem with A and B Side Piston Pressure Transducer or Transducer Connection	6
R2-A:B Ratio Low	A:B Ratio is low, relative to calibration and user-input allowable variance (Ratio Assurance Option Only).	6
R3-A:B Ratio High	A:B Ratio is high, relative to calibration and user-input allowable variance (Ratio Assurance Option Only).	6
T201-D-Low Material Temp Z1	Material Below Temperature, Zone #1	8
T202-D-Low Material Temp Z2	Material Below Temperature, Zone #2	8
T203-D-Low Material Temp Z3	Material Below Temperature, Zone #3	8
T204-D-Low Material Temp Z4	Material Below Temperature, Zone #4	8
T401-A-High Material Temp Z1	Material Over Temperature, Zone #1	7
T402-A-High Material Temp Z2	Material Over Temperature, Zone #2	7
T403-A-High Material Temp Z3	Material Over Temperature, Zone #3	7
T404-A-High Material Temp Z4	Material Over Temperature, Zone #4	7
T4C1-A-Blanket Over Temp Z1	Blanket Over Temperature, Zone #1	7
T4C2-A-Blanket Over Temp Z2	Blanket Over Temperature, Zone #2	7
T4C3-A-Blanket Over Temp Z3	Blanket Over Temperature, Zone #3	7
T4C4-A-Blanket Over Temp Z4	Blanket Over Temperature, Zone #4	7
T601-A-Material RTD Fault Z1	Material RTD Fault, Zone #1	7
T602-A-Material RTD Fault Z2	Material RTD Fault, Zone #2	7
T603-A-Material RTD Fault Z3	Material RTD Fault, Zone #3	7
T604-A-Material RTD Fault Z4	Material RTD Fault, Zone #4	7
T6C1-A-Blanket RTD Fault Z1	Blanket RTD Fault, Zone #1	7
T6C2-A-Blanket RTD Fault Z2	Blanket RTD Fault, Zone #2	7
T6C3-A-Blanket RTD Fault Z3	Blanket RTD Fault, Zone #3	7
T6C4-A-Blanket RTD Fault Z4	Blanket RTD Fault, Zone #4	7
T801-D-No Heat Z1	No Temperature Rise, Zone #1	8
T802-D-No Heat Z2	No Temperature Rise, Zone #2	8

Code-Class-Event Shown on Errors Screen	Description	System Behavior Ref
T803-D-No Heat Z3	No Temperature Rise, Zone #3	8
T804-D-No Heat Z4	No Temperature Rise, Zone #4	8
T901-A-Temp Switch Cutoff Z1	Over Temp Switch Open, Zone #1	7
T902-A-Temp Switch Cutoff Z2	Over Temp Switch Open, Zone #2	7
T903-A-Temp Switch Cutoff Z3	Over Temp Switch Open, Zone #3	7
T904-A-Temp Switch Cutoff Z4	Over Temp Switch Open, Zone #4	7
T9C1-A-Control Shutdown Z1	PCB Over Temperature, Zone #1	7
T9C2-A-Control Shutdown Z2	PCB Over Temperature, Zone #2	7
T9C3-A-Control Shutdown Z3	PCB Over Temperature, Zone #3	7
T9C4-A-Control Shutdown Z4	PCB Over Temperature, Zone #4	7
WM01-A-Current Fault Z1	High Relay 1 Current, Zone #1	7
WM02-A-Current Fault Z2	High Relay 1 Current, Zone #2	7
WM03-A-Current Fault Z3	High Relay 1 Current, Zone #3	7
WM04-A-Current Fault Z4	High Relay 1 Current, Zone #4	7
WMC1-A-Control Fault Z1	Unexpected Relay 1 Current, Zone #1	7
WMC2-A-Control Fault Z2	Unexpected Relay 1 Current, Zone #2	7
WMC3-A-Control Fault Z3	Unexpected Relay 1 Current, Zone #3	7
WMC4-A-Control Fault Z4	Unexpected Relay 1 Current, Zone #4	7
WSC0-D-Invalid Flow Request	Flow setpoint entered is too high or too low for machine	8

Light Tower Accessory (Optional)







Part Number	Description
255468	Light Tower Kit

Light Tower (Optional)

Signal	Description
Green on only	System is powered up and there are no error conditions present
Yellow on	An advisory exists
Red flashing	A deviation exists
Red on	The system is shut down due to an alarm occurring.

Errors include advisories, deviations, or alarms, so green will only be on when none of these occur. A yellow light can be on at the same time as red (flashing or solid on) when an advisory exists at the same time as a deviation or alarm.

System Behavior Descriptions

System Behavior Reference	System Behavior Description
1	When this error is generated, a pop-up with the error-code will be shown until it is acknowledged by pressing the Enter button (). The heat control will be turned off, any auto-sequencing in progress will be stopped, and the foot switch will be disabled until the error-code is acknowledged. When the error condition is cleared, the heat control may be turned back on from the Home screen. This error will not disable purge or recirculation operation.
2	When this error is generated, a pop-up with the error-code will be shown until it is acknowledged by pressing the Enter button (). All physical machine operation will be disabled until the error condition is corrected. The display module can still be used but all machine commands sent will be ignored.
3	When this error is generated, a pop-up with the error-code will be shown until it is acknowledged by pressing the Enter button (). Any auto-sequencing in progress will be stopped and the foot switch will be disabled until the error-code is acknowledged. This error will not disable purge or recirculation operation. All features dependent on Fluid Control Module #2 will be disabled until the error condition is corrected.
4	When this error is generated, a pop-up with the error-code will be shown continuously until the error condition is corrected. The machine and display module are completely disabled until the error condition is corrected.
5	When this error is generated, a pop-up with the error-code will be shown. Any auto-sequencing, purge timer or recirculation timer operation in progress will be stopped and the foot switch will be disabled until the error-condition is cleared. The error-code pop-up will be shown until the error condition is cleared. When the error condition is cleared, all options may be turned back on.
6	When this error is generated, a pop-up with the error-code will be shown until it is acknowledged by pressing the Enter button (). Any auto-sequencing in progress will be stopped, and the foot switch will be disabled until the error-code is acknowledged. Once the error-code pop-up is acknowledged, the machine will return to normal operation. The error will be shown in the Errors screen until the condition is cleared. The error-code pop-up will not reappear unless the error condition is cleared and then reappears. This error will not disable purge or recirculation operation.
7	When this error is generated, a pop-up with the error-code will be shown until it is acknowledged by pressing the Enter button (). All heat options will be turned off, any auto-sequencing in progress will be stopped, and the foot switch will be disabled until the error-code is acknowledged. When the error condition is cleared, the heat control may be turned back on from the Home screen. This error will not disable purge or recirculation operation.
8	When this error is generated, a pop-up with the error-code will be shown until it is acknowledged by pressing the Enter button (). All heat options will remain on, any auto-sequencing in progress will be stopped, and the foot switch will be disabled until the error-code is acknowledged. This error will not disable purge or recirculation operation.

Appendix B - ADM Screen Icons

Icon	Description
	Enter Screen
	Exit Screen
	Select Operating Mode
	Shot Number (example)
	Constant torque
	Constant flow
	Dispense Start
	Dispense Stop
	Fully extend piston
	Fully retract piston
	Metering tube position
	Dispense valve position
	Positive or negative values
	Phase adjustment
	Short shot dispense
	Long shot dispense
	Activate reset of control data or material counters
	Reset control data or material counters

Icon	Description
	Manual pump loading
	Sequence position (example)
	Reset sequence
	A side material exits dispense nozzle before B side
	B side material exits dispense nozzle before A side
	Start base purge option
	Stop base purge option
	Start tank fill operation
	Stop tank fill operation
	Fill tank x (A or B) option

Appendix C - Product Pump Selection Guide

When selecting the pumps for the fixed ratio PR70f, you need to know the material ratio, expected dispense flow rate, and minimum programmed dispense amount. The tables listed here provide guidance for the standard pump sizes available with the PR70f.

For example, if a PR70f needs to dispense at a volumetric ratio of 2:1, the information in tables 1.1 - 1.2 shows that 16 A and B pump combinations are available:

- 80:160
- 100:200
- 130:240
- 140:280
- 160:320
- 180:360
- 200:400
- 220:440
- 240:480
- 260:520
- 300:600
- 320:640
- 360:720
- 400:800
- 440:880
- 480:960

In this example, it is also necessary to dispense at flow rates of 5 cc/second or slower. Based on the flow rates provided by tables 3.1 - 3.3, all the pump combinations can operate up to those flow rates.

Although the PR70f has over a 1300 to 1 dynamic range between maximum and minimum flow rates (maximum flow divided by minimum flow is greater than 1300), it performs best when operating at rates less than 1/10 of the maximum flow rate specified. That eliminates the following pump combinations from the list above.

Pump Combination	Maximum Flow Rate Specified	1/10 of Maximum
80:160	28.3 cc/sec.	2.83 cc/sec
100:200	35.4 cc/sec	3.54 cc/sec
120:240	42.4 cc/sec	4.24 cc/sec
140:280	49.5 cc/sec	4.95 cc/sec

Continuing with this example, the PR70f needs to dispense 5 cc or more of material for each dispense. If the dispenses cannot start with the pumps loaded and stalled at the metering tube entrance, the minimum dispense amounts shown in tables 2.1 – 2.3 need to be considered. **If the pumps can be pre-loaded at the metering tube entrance before a dispense, the minimum amounts in the 2.1 – 2.3 tables can be ignored (see Appendix D - Small Amount Shot Mode Dispensing on page 102).** If the pumps cannot be pre-loaded before a dispense, the following pump combinations are eliminated from the original list.

Pump Combination	Minimum Shot Dispense Amount
480:960	9.42 cc
440:880	8.64 cc
400:800	7.85 cc
360:720	7.07 cc
320:640	6.28 cc
300:600	5.89 cc
260:520	5.10 cc

Five pump combinations remain and are the ones that will work best for the application described in this example.

- 160:320
- 180:360
- 200:400
- 220:440
- 240:480

NOTE: These tables include Super and Standard pump sizes. For clarity, the Super pump sizes are indicated in **RED**.

Table 1.1: PR70f Fixed Ratio A/B Volumetric Ratios with Super and Standard Pump Sizes
80-320 pump sizes

80	100	120	140	160	180	200	220	240	260	280	300	320	
0.083	0.104	0.125	0.146	0.167	0.188	0.208	0.229	0.250	0.271	0.292	0.313	0.333	960
0.091	0.114	0.136	0.159	0.182	0.205	0.227	0.250	0.273	0.295	0.318	0.341	0.364	880
0.100	0.125	0.150	0.175	0.200	0.225	0.250	0.275	0.300	0.325	0.350	0.375	0.400	800
0.111	0.139	0.167	0.194	0.222	0.250	0.278	0.306	0.333	0.361	0.389	0.417	0.444	720
0.125	0.156	0.188	0.219	0.250	0.281	0.313	0.344	0.375	0.406	0.438	0.469	0.500	640
0.133	0.167	0.200	0.233	0.267	0.300	0.333	0.367	0.400	0.433	0.467	0.500	0.533	600
0.143	0.179	0.214	0.250	0.286	0.321	0.357	0.393	0.429	0.464	0.500	0.536	0.571	560
0.154	0.192	0.231	0.269	0.308	0.346	0.385	0.423	0.462	0.500	0.538	0.577	0.615	520
0.167	0.208	0.250	0.292	0.333	0.375	0.417	0.458	0.500	0.542	0.583	0.625	0.667	480
0.182	0.227	0.273	0.318	0.364	0.409	0.455	0.500	0.545	0.591	0.636	0.682	0.727	440
0.200	0.250	0.300	0.350	0.400	0.450	0.500	0.550	0.600	0.650	0.700	0.750	0.800	400
0.222	0.278	0.333	0.389	0.444	0.500	0.556	0.611	0.667	0.722	0.778	0.833	0.889	360
0.250	0.313	0.375	0.438	0.500	0.563	0.625	0.688	0.750	0.813	0.875	0.938	1.000	320
0.267	0.333	0.400	0.467	0.533	0.600	0.667	0.733	0.800	0.867	0.933	1.000	1.067	300
0.286	0.357	0.429	0.500	0.571	0.643	0.714	0.786	0.857	0.929	1.000	1.071	1.143	280
0.308	0.385	0.462	0.538	0.615	0.692	0.769	0.846	0.923	1.000	1.077	1.154	1.231	260
0.333	0.417	0.500	0.583	0.667	0.750	0.833	0.917	1.000	1.083	1.167	1.250	1.333	240
0.364	0.455	0.545	0.636	0.727	0.818	0.909	1.000	1.091	1.182	1.273	1.364	1.455	220
0.400	0.500	0.600	0.700	0.800	0.900	1.000	1.100	1.200	1.300	1.400	1.500	1.600	200
0.444	0.556	0.667	0.778	0.889	1.000	1.111	1.222	1.333	1.444	1.556	1.667	1.778	180
0.500	0.625	0.750	0.875	1.000	1.125	1.250	1.375	1.500	1.625	1.750	1.875	2.000	160
0.571	0.714	0.857	1.000	1.143	1.286	1.429	1.571	1.714	1.857	2.000	2.143	2.286	140
0.667	0.833	1.000	1.167	1.333	1.500	1.667	1.833	2.000	2.167	2.333	2.500	2.667	120
0.800	1.000	1.200	1.400	1.600	1.800	2.000	2.200	2.400	2.600	2.800	3.000	3.200	100
1.000	1.250	1.500	1.750	2.000	2.250	2.500	2.750	3.000	3.250	3.500	3.750	4.000	80

Table 1.2: PR70f Fixed Ratio A/B Volumetric Ratios with Super and Standard Pump Sizes
 360-960 pump sizes

360	400	440	480	520	560	600	640	720	800	880	960	
0.375	0.417	0.458	0.500	0.542	0.583	0.625	0.667	0.750	0.833	0.917	1.000	960
0.409	0.455	0.500	0.545	0.591	0.636	0.682	0.727	0.818	0.909	1.000	1.091	880
0.450	0.500	0.550	0.600	0.650	0.700	0.750	0.800	0.900	1.000	1.100	1.200	800
0.500	0.556	0.611	0.667	0.722	0.778	0.833	0.889	1.000	1.111	1.222	1.333	720
0.563	0.625	0.688	0.750	0.813	0.875	0.938	1.000	1.125	1.250	1.375	1.500	640
0.600	0.667	0.733	0.800	0.867	0.933	1.000	1.067	1.200	1.333	1.467	1.600	600
0.643	0.714	0.786	0.857	0.929	1.000	1.071	1.143	1.286	1.429	1.571	1.714	560
0.692	0.769	0.846	0.923	1.000	1.077	1.154	1.231	1.385	1.538	1.692	1.846	520
0.750	0.833	0.917	1.000	1.083	1.167	1.250	1.333	1.500	1.667	1.833	2.000	480
0.818	0.909	1.000	1.091	1.182	1.273	1.364	1.455	1.636	1.818	2.000	2.182	440
0.900	1.000	1.100	1.200	1.300	1.400	1.500	1.600	1.800	2.000	2.200	2.400	400
1.000	1.111	1.222	1.333	1.444	1.556	1.667	1.778	2.000	2.222	2.444	2.667	360
1.125	1.250	1.375	1.500	1.625	1.750	1.875	2.000	2.250	2.500	2.750	3.000	320
1.200	1.333	1.467	1.600	1.733	1.867	2.000	2.133	2.400	2.667	2.933	3.200	300
1.286	1.429	1.571	1.714	1.857	2.000	2.143	2.286	2.571	2.857	3.143	3.429	280
1.385	1.538	1.692	1.846	2.000	2.154	2.308	2.462	2.769	3.077	3.385	3.692	260
1.500	1.667	1.833	2.000	2.167	2.333	2.500	2.667	3.000	3.333	3.667	4.000	240
1.636	1.818	2.000	2.182	2.364	2.545	2.727	2.909	3.273	3.636	4.000	4.364	220
1.800	2.000	2.200	2.400	2.600	2.800	3.000	3.200	3.600	4.000	4.400	4.800	200
2.000	2.222	2.444	2.667	2.889	3.111	3.333	3.556	4.000	4.444	4.889	5.333	180
2.250	2.500	2.750	3.000	3.250	3.500	3.750	4.000	4.500	5.000	5.500	6.000	160
2.571	2.857	3.143	3.429	3.714	4.000	4.286	4.571	5.143	5.714	6.286	6.857	140
3.000	3.333	3.667	4.000	4.333	4.667	5.000	5.333	6.000	6.667	7.333	8.000	120
3.600	4.000	4.400	4.800	5.200	5.600	6.000	6.400	7.200	8.000	8.800	9.600	100
4.500	5.000	5.500	6.000	6.500	7.000	7.500	8.000	9.000	10.000	11.000	12.000	80

Table 2.1: PR70f Maximum and Minimum Single Stroke Shot Mode Dispense Sizes (cc) with Super and Standard Pump Sizes

80-220 pump sizes

80	100	120	140	160	180	200	220	
44.1 6.80	45.0 6.93	45.8 7.07	46.7 7.20	47.5 7.33	48.4 7.46	49.2 7.59	50.1 7.72	960
40.7 6.28	41.6 6.41	42.4 6.54	43.3 6.67	44.1 6.80	45.0 6.93	45.8 7.07	46.7 7.20	880
37.3 5.76	38.2 5.89	39.0 6.02	39.9 6.15	40.7 6.28	41.6 6.41	42.4 6.54	43.3 6.67	800
33.9 5.23	34.8 5.36	35.6 5.50	36.5 5.63	37.3 5.76	38.2 5.89	39.0 6.02	39.9 6.15	720
30.5 4.71	31.4 4.84	32.2 4.97	33.1 5.10	33.9 5.23	34.8 5.36	35.6 5.50	36.5 5.63	640
28.8 4.45	29.7 4.58	30.5 4.71	31.4 4.84	32.2 4.97	33.1 5.10	33.9 5.23	34.8 5.36	600
27.2 4.19	28.0 4.32	28.8 4.45	29.7 4.58	30.5 4.71	31.4 4.84	32.2 4.97	33.1 5.10	560
25.5 3.93	26.3 4.06	27.2 4.19	28.0 4.32	28.8 4.45	29.7 4.58	30.5 4.71	31.4 4.84	520
23.8 3.66	24.6 3.79	25.5 3.93	26.3 4.06	27.2 4.19	28.0 4.32	28.8 4.45	29.7 4.58	480
22.1 3.40	22.9 3.53	23.8 3.66	24.6 3.79	25.5 3.93	26.3 4.06	27.2 4.19	28.0 4.32	440
20.4 3.14	21.2 3.27	22.1 3.40	22.9 3.53	23.8 3.66	24.6 3.79	25.5 3.93	26.3 4.06	400
18.7 2.88	19.5 3.01	20.4 3.14	21.2 3.27	22.1 3.40	22.9 3.53	23.8 3.66	24.6 3.79	360
17.0 2.62	17.8 2.75	18.7 2.88	19.5 3.01	20.4 3.14	21.2 3.27	22.1 3.40	22.9 3.53	320
16.1 2.49	17.0 2.62	17.8 2.75	18.7 2.88	19.5 3.01	20.4 3.14	21.2 3.27	22.1 3.40	300
15.3 2.36	16.1 2.49	17.0 2.62	17.8 2.75	18.7 2.88	19.5 3.01	20.4 3.14	21.2 3.27	280
14.4 2.22	15.3 2.36	16.1 2.49	17.0 2.62	17.8 2.75	18.7 2.88	19.5 3.01	20.4 3.14	260
13.6 2.09	14.4 2.22	15.3 2.36	16.1 2.49	17.0 2.62	17.8 2.75	18.7 2.88	19.5 3.01	240
12.7 1.96	13.6 2.09	14.4 2.22	15.3 2.36	16.1 2.49	17.0 2.62	17.8 2.75	18.7 2.88	220
11.9 1.83	12.7 1.96	13.6 2.09	14.4 2.22	15.3 2.36	16.1 2.49	17.0 2.62	17.8 2.75	200
11.0 1.70	11.9 1.83	12.7 1.96	13.6 2.09	14.4 2.22	15.3 2.36	16.1 2.49	17.0 2.62	180
10.2 1.57	11.0 1.70	11.9 1.83	12.7 1.96	13.6 2.09	14.4 2.22	15.3 2.36	16.1 2.49	160
9.3 1.44	10.2 1.57	11.0 1.70	11.9 1.83	12.7 1.96	13.6 2.09	14.4 2.22	15.3 2.36	140
8.5 1.31	9.3 1.44	10.2 1.57	11.0 1.70	11.9 1.83	12.7 1.96	13.6 2.09	14.4 2.22	120
7.6 1.18	8.5 1.31	9.3 1.44	10.2 1.57	11.0 1.70	11.9 1.83	12.7 1.96	13.6 2.09	100
6.8 1.05	7.6 1.18	8.5 1.31	9.3 1.44	10.2 1.57	11.0 1.70	11.9 1.83	12.7 1.96	80

NOTE: The Minimum Stroke Amounts specified in the table can be ignored if the pumps are pre-loaded at the metering tube entrance prior to a dispense (“Auto-Load Pump After Dispense” feature on Advanced #4 Screen is ON). If the pumps are pre-loaded, or the pump is “Paused” (“Dispense Pause/ Stepping ON” checked on the Advanced #4 setup screen) within the metering tube, the PR70F will accept any shot mode dispense amount. See Appendix D for details on dispensing small amounts.

NOTE: Minimum shot sizes specified may be less than the specified amounts on other PR70 products.

Table 2.2: PR70f Maximum and Minimum Single Stroke Shot Mode Dispense Sizes (cc) with Super and Standard Pump Sizes

240-440 pump sizes

240	260	280	300	320	360	400	440	
50.9 7.85	51.8 7.98	52.6 8.11	53.5 8.24	54.3 8.37	56.0 8.64	57.7 8.90	59.4 9.16	960
47.5 7.33	48.4 7.46	49.2 7.59	50.1 7.72	50.9 7.85	52.6 8.11	54.3 8.37	56.0 8.64	880
44.1 6.80	45.0 6.93	45.8 7.07	46.7 7.20	47.5 7.33	49.2 7.59	50.9 7.85	52.6 8.11	800
40.7 6.28	41.6 6.41	42.4 6.54	43.3 6.67	44.1 6.80	45.8 7.07	47.5 7.33	49.2 7.59	720
37.3 5.76	38.2 5.89	39.0 6.02	39.9 6.15	40.7 6.28	42.4 6.54	44.1 6.80	45.8 7.07	640
35.6 5.50	36.5 5.63	37.3 5.76	38.2 5.89	39.0 6.02	40.7 6.28	42.4 6.54	44.1 6.80	600
33.9 5.23	34.8 5.36	35.6 5.50	36.5 5.63	37.3 5.76	39.0 6.02	40.7 6.28	42.4 6.54	560
32.2 4.97	33.1 5.10	33.9 5.23	34.8 5.36	35.6 5.50	37.3 5.76	39.0 6.02	40.7 6.28	520
30.5 4.71	31.4 4.84	32.2 4.97	33.1 5.10	33.9 5.23	35.6 5.50	37.3 5.76	39.0 6.02	480
28.8 4.45	29.7 4.58	30.5 4.71	31.4 4.84	32.2 4.97	33.9 5.23	35.6 5.50	37.3 5.76	440
27.2 4.19	28.0 4.32	28.8 4.45	29.7 4.58	30.5 4.71	32.2 4.97	33.9 5.23	35.6 5.50	400
25.5 3.93	26.3 4.06	27.2 4.19	28.0 4.32	28.8 4.45	30.5 4.71	32.2 4.97	33.9 5.23	360
23.8 3.66	24.6 3.79	25.5 3.93	26.3 4.06	27.2 4.19	28.8 4.45	30.5 4.71	32.2 4.97	320
22.9 3.53	23.8 3.66	24.6 3.79	25.5 3.93	26.3 4.06	28.0 4.32	29.7 4.58	31.4 4.84	300
22.1 3.40	22.9 3.53	23.8 3.66	24.6 3.79	25.5 3.93	27.2 4.19	28.8 4.45	30.5 4.71	280
21.2 3.27	22.1 3.40	22.9 3.53	23.8 3.66	24.6 3.79	26.3 4.06	28.0 4.32	29.7 4.58	260
20.4 3.14	21.2 3.27	22.1 3.40	22.9 3.53	23.8 3.66	25.5 3.93	27.2 4.19	28.8 4.45	240
19.5 3.01	20.4 3.14	21.2 3.27	22.1 3.40	22.9 3.53	24.6 3.79	26.3 4.06	28.0 4.32	220
18.7 2.88	19.5 3.01	20.4 3.14	21.2 3.27	22.1 3.40	23.8 3.66	25.5 3.93	27.2 4.19	200
17.8 2.75	18.7 2.88	19.5 3.01	20.4 3.14	21.2 3.27	22.9 3.53	24.6 3.79	26.3 4.06	180
17.0 2.62	17.8 2.75	18.7 2.88	19.5 3.01	20.4 3.14	22.1 3.40	23.8 3.66	25.5 3.93	160
16.1 2.49	17.0 2.62	17.8 2.75	18.7 2.88	19.5 3.01	21.2 3.27	22.9 3.53	24.6 3.79	140
15.3 2.36	16.1 2.49	17.0 2.62	17.8 2.75	18.7 2.88	20.4 3.14	22.1 3.40	23.8 3.66	120
14.4 2.22	15.3 2.36	16.1 2.49	17.0 2.62	17.8 2.75	19.5 3.01	21.2 3.27	22.9 3.53	100
13.6 2.09	14.4 2.22	15.3 2.36	16.1 2.49	17.0 2.62	18.7 2.88	20.4 3.14	22.1 3.40	80

NOTE: The Minimum Stroke Amounts specified in the table can be ignored if the pumps are pre-loaded at the metering tube entrance prior to a dispense (“Auto-Load Pump After Dispense” feature on Advanced #4 Screen is ON). If the pumps are pre-loaded, or the pump is “Paused” (“Dispense Pause/ Stepping ON” checked on the Advanced #4 setup screen) within the metering tube, the PR70F will accept any shot mode dispense amount. See Appendix D for details on dispensing small amounts.

NOTE: Minimum shot sizes specified may be less than the specified amounts on other PR70 products.

Table 2.3: PR70f Maximum and Minimum Single Stroke Shot Mode Dispense Sizes (cc) with Super and Standard Pump Sizes

480 -960 pump sizes

480	520	560	600	640	720	800	880	960	
61.1 9.42	62.8 9.68	64.5 9.94	66.2 10.21	67.9 10.47	71.3 10.99	74.7 11.51	78.1 12.04	81.5 12.56	960
57.7 8.90	59.4 9.16	61.1 9.42	62.8 9.68	64.5 9.94	67.9 10.47	71.3 10.99	74.7 11.51	78.1 12.04	880
54.3 8.37	56.0 8.64	57.7 8.90	59.4 9.16	61.1 9.42	64.5 9.94	67.9 10.47	71.3 10.99	74.7 11.51	800
50.9 7.85	52.6 8.11	54.3 8.37	56.0 8.64	57.7 8.90	61.1 9.42	64.5 9.94	67.9 10.47	71.3 10.99	720
47.5 7.33	49.2 7.59	50.9 7.85	52.6 8.11	54.3 8.37	57.7 8.90	61.1 9.42	64.5 9.94	67.9 10.47	640
45.8 7.07	47.5 7.33	49.2 7.59	50.9 7.85	52.6 8.11	56.0 8.64	59.4 9.16	62.8 9.68	66.2 10.21	600
44.1 6.80	45.8 7.07	47.5 7.33	49.2 7.59	50.9 7.85	54.3 8.37	57.7 8.90	61.1 9.42	64.5 9.94	560
42.4 6.54	44.1 6.80	45.8 7.07	47.5 7.33	49.2 7.59	52.6 8.11	56.0 8.64	59.4 9.16	62.8 9.68	520
40.7 6.28	42.4 6.54	44.1 6.80	45.8 7.07	47.5 7.33	50.9 7.85	54.3 8.37	57.7 8.90	61.1 9.42	480
39.0 6.02	40.7 6.28	42.4 6.54	44.1 6.80	45.8 7.07	49.2 7.59	52.6 8.11	56.0 8.64	59.4 9.16	440
37.3 5.76	39.0 6.02	40.7 6.28	42.4 6.54	44.1 6.80	47.5 7.33	50.9 7.85	54.3 8.37	57.7 8.90	400
35.6 5.50	37.3 5.76	39.0 6.02	40.7 6.28	42.4 6.54	45.8 7.07	49.2 7.59	52.6 8.11	56.0 8.64	360
33.9 5.23	35.6 5.50	37.3 5.76	39.0 6.02	40.7 6.28	44.1 6.80	47.5 7.33	50.9 7.85	54.3 8.37	320
33.1 5.10	34.8 5.36	36.5 5.63	38.2 5.89	39.9 6.15	43.3 6.67	46.7 7.20	50.1 7.72	53.5 8.24	300
32.2 4.97	33.9 5.23	35.6 5.50	37.3 5.76	39.0 6.02	42.4 6.54	45.8 7.07	49.2 7.59	52.6 8.11	280
31.4 4.84	33.1 5.10	34.8 5.36	36.5 5.63	38.2 5.89	41.6 6.41	45.0 6.93	48.4 7.46	51.8 7.98	260
30.5 4.71	32.2 4.97	33.9 5.23	35.6 5.50	37.3 5.76	40.7 6.28	44.1 6.80	47.5 7.33	50.9 7.85	240
29.7 4.58	31.4 4.84	33.1 5.10	34.8 5.36	36.5 5.63	39.9 6.15	43.3 6.67	46.7 7.20	50.1 7.72	220
28.8 4.45	30.5 4.71	32.2 4.97	33.9 5.23	35.6 5.50	39.0 6.02	42.4 6.54	45.8 7.07	49.2 7.59	200
28.0 4.32	29.7 4.58	31.4 4.84	33.1 5.10	34.8 5.36	38.2 5.89	41.6 6.41	45.0 6.93	48.4 7.46	180
27.2 4.19	28.8 4.45	30.5 4.71	32.2 4.97	33.9 5.23	37.3 5.76	40.7 6.28	44.1 6.80	47.5 7.33	160
26.3 4.06	28.0 4.32	29.7 4.58	31.4 4.84	33.1 5.10	36.5 5.63	39.9 6.15	43.3 6.67	46.7 7.20	140
25.5 3.93	27.2 4.19	28.8 4.45	30.5 4.71	32.2 4.97	35.6 5.50	39.0 6.02	42.4 6.54	45.8 7.07	120
24.6 3.79	26.3 4.06	28.0 4.32	29.7 4.58	31.4 4.84	34.8 5.36	38.2 5.89	41.6 6.41	45.0 6.93	100
23.8 3.66	25.5 3.93	27.2 4.19	28.8 4.45	30.5 4.71	33.9 5.23	37.3 5.76	40.7 6.28	44.1 6.80	80

NOTE: The Minimum Stroke Amounts specified in the table can be ignored if the pumps are pre-loaded at the metering tube entrance prior to a dispense (“Auto-Load Pump After Dispense” feature on Advanced #4 Screen is ON). If the pumps are pre-loaded, or the pump is “Paused” (“Dispense Pause/ Stepping ON” checked on the Advanced #4 setup screen) within the metering tube, the PR70F will accept any shot mode dispense amount. See Appendix D for details on dispensing small amounts.

NOTE: Minimum shot sizes specified may be less than the specified amounts on other PR70 products.

Table 3.1: PR70f Maximum and Minimum Flow Rates (cc/s) with Super and Standard Pump Sizes

80-220 pump sizes

80	100	120	140	160	180	200	220	
122.6 0.091	124.9 0.093	127.3 0.095	129.6 0.096	132.0 0.098	134.3 0.100	136.7 0.102	139.1 0.103	960
113.1 0.084	115.5 0.086	117.8 0.088	120.2 0.089	122.6 0.091	124.9 0.093	127.3 0.095	129.6 0.096	880
103.7 0.077	106.1 0.079	108.4 0.081	110.8 0.082	113.1 0.084	115.5 0.086	117.8 0.088	120.2 0.089	800
94.3 0.070	96.6 0.072	99.0 0.074	101.3 0.075	103.7 0.077	106.1 0.079	108.4 0.081	110.8 0.082	720
84.8 0.063	87.2 0.065	89.6 0.067	91.9 0.068	94.3 0.070	96.6 0.072	99.0 0.074	101.3 0.075	640
80.1 0.060	82.5 0.061	84.8 0.063	87.2 0.065	89.6 0.067	91.9 0.068	94.3 0.070	96.6 0.072	600
75.4 0.056	77.8 0.058	80.1 0.060	82.5 0.061	84.8 0.063	87.2 0.065	89.6 0.067	91.9 0.068	560
70.7 0.053	73.1 0.054	75.4 0.056	77.8 0.058	80.1 0.060	82.5 0.061	84.8 0.063	87.2 0.065	520
66.0 0.049	68.3 0.051	70.7 0.053	73.1 0.054	75.4 0.056	77.8 0.058	80.1 0.060	82.5 0.061	480
61.3 0.046	63.6 0.047	66.0 0.049	68.3 0.051	70.7 0.053	73.1 0.054	75.4 0.056	77.8 0.058	440
56.6 0.042	58.9 0.044	61.3 0.046	63.6 0.047	66.0 0.049	68.3 0.051	70.7 0.053	73.1 0.054	400
51.8 0.039	54.2 0.040	56.6 0.042	58.9 0.044	61.3 0.046	63.6 0.047	66.0 0.049	68.3 0.051	360
47.1 0.035	49.5 0.037	51.8 0.039	54.2 0.040	56.6 0.042	58.9 0.044	61.3 0.046	63.6 0.047	320
44.8 0.033	47.1 0.035	49.5 0.037	51.8 0.039	54.2 0.040	56.6 0.042	58.9 0.044	61.3 0.046	300
42.4 0.032	44.8 0.033	47.1 0.035	49.5 0.037	51.8 0.039	54.2 0.040	56.6 0.042	58.9 0.044	280
40.1 0.030	42.4 0.032	44.8 0.033	47.1 0.035	49.5 0.037	51.8 0.039	54.2 0.040	56.6 0.042	260
37.7 0.028	40.1 0.030	42.4 0.032	44.8 0.033	47.1 0.035	49.5 0.037	51.8 0.039	54.2 0.040	240
35.4 0.026	37.7 0.028	40.1 0.030	42.4 0.032	44.8 0.033	47.1 0.035	49.5 0.037	51.8 0.039	220
33.0 0.025	35.4 0.026	37.7 0.028	40.1 0.030	42.4 0.032	44.8 0.033	47.1 0.035	49.5 0.037	200
30.6 0.023	33.0 0.025	35.4 0.026	37.7 0.028	40.1 0.030	42.4 0.032	44.8 0.033	47.1 0.035	180
28.3 0.021	30.6 0.023	33.0 0.025	35.4 0.026	37.7 0.028	40.1 0.030	42.4 0.032	44.8 0.033	160
25.9 0.019	28.3 0.021	30.6 0.023	33.0 0.025	35.4 0.026	37.7 0.028	40.1 0.030	42.4 0.032	140
23.6 0.018	25.9 0.019	28.3 0.021	30.6 0.023	33.0 0.025	35.4 0.026	37.7 0.028	40.1 0.030	120
21.2 0.016	23.6 0.018	25.9 0.019	28.3 0.021	30.6 0.023	33.0 0.025	35.4 0.026	37.7 0.028	100
18.9 0.014	21.2 0.016	23.6 0.018	25.9 0.019	28.3 0.021	30.6 0.023	33.0 0.025	35.4 0.026	80

Table 3.2: PR70f Maximum and Minimum Flow Rates (cc/s) with Super and Standard Pump Sizes
240-440 pump sizes

240	260	280	300	320	360	400	440	
141.4 0.105	143.8 0.107	146.1 0.109	148.5 0.110	150.8 0.112	155.5 0.116	160.3 0.119	165.0 0.123	960
132.0 0.098	134.3 0.100	136.7 0.102	139.1 0.103	141.4 0.105	146.1 0.109	150.8 0.112	155.5 0.116	880
122.6 0.091	124.9 0.093	127.3 0.095	129.6 0.096	132.0 0.098	136.7 0.102	141.4 0.105	146.1 0.109	800
113.1 0.084	115.5 0.086	117.8 0.088	120.2 0.089	122.6 0.091	127.3 0.095	132.0 0.098	136.7 0.102	720
103.7 0.077	106.1 0.079	108.4 0.081	110.8 0.082	113.1 0.084	117.8 0.088	122.6 0.091	127.3 0.095	640
99.0 0.074	101.3 0.075	103.7 0.077	106.1 0.079	108.4 0.081	113.1 0.084	117.8 0.088	122.6 0.091	600
94.3 0.070	96.6 0.072	99.0 0.074	101.3 0.075	103.7 0.077	108.4 0.081	113.1 0.084	117.8 0.088	560
89.6 0.067	91.9 0.068	94.3 0.070	96.6 0.072	99.0 0.074	103.7 0.077	108.4 0.081	113.1 0.084	520
84.8 0.063	87.2 0.065	89.6 0.067	91.9 0.068	94.3 0.070	99.0 0.074	103.7 0.077	108.4 0.081	480
80.1 0.060	82.5 0.061	84.8 0.063	87.2 0.065	89.6 0.067	94.3 0.070	99.0 0.074	103.7 0.077	440
75.4 0.056	77.8 0.058	80.1 0.060	82.5 0.061	84.8 0.063	89.6 0.067	94.3 0.070	99.0 0.074	400
70.7 0.053	73.1 0.054	75.4 0.056	77.8 0.058	80.1 0.060	84.8 0.063	89.6 0.067	94.3 0.070	360
66.0 0.049	68.3 0.051	70.7 0.053	73.1 0.054	75.4 0.056	80.1 0.060	84.8 0.063	89.6 0.067	320
63.6 0.047	66.0 0.049	68.3 0.051	70.7 0.053	73.1 0.054	77.8 0.058	82.5 0.061	87.2 0.065	300
61.3 0.046	63.6 0.047	66.0 0.049	68.3 0.051	70.7 0.053	75.4 0.056	80.1 0.060	84.8 0.063	280
58.9 0.044	61.3 0.046	63.6 0.047	66.0 0.049	68.3 0.051	73.1 0.054	77.8 0.058	82.5 0.061	260
56.6 0.042	58.9 0.044	61.3 0.046	63.6 0.047	66.0 0.049	70.7 0.053	75.4 0.056	80.1 0.060	240
54.2 0.040	56.6 0.042	58.9 0.044	61.3 0.046	63.6 0.047	68.3 0.051	73.1 0.054	77.8 0.058	220
51.8 0.039	54.2 0.040	56.6 0.042	58.9 0.044	61.3 0.046	66.0 0.049	70.7 0.053	75.4 0.056	200
49.5 0.037	51.8 0.039	54.2 0.040	56.6 0.042	58.9 0.044	63.6 0.047	68.3 0.051	73.1 0.054	180
47.1 0.035	49.5 0.037	51.8 0.039	54.2 0.040	56.6 0.042	61.3 0.046	66.0 0.049	70.7 0.053	160
44.8 0.033	47.1 0.035	49.5 0.037	51.8 0.039	54.2 0.040	58.9 0.044	63.6 0.047	68.3 0.051	140
42.4 0.032	44.8 0.033	47.1 0.035	49.5 0.037	51.8 0.039	56.6 0.042	61.3 0.046	66.0 0.049	120
40.1 0.030	42.4 0.032	44.8 0.033	47.1 0.035	49.5 0.037	54.2 0.040	58.9 0.044	63.6 0.047	100
37.7 0.028	40.1 0.030	42.4 0.032	44.8 0.033	47.1 0.035	51.8 0.039	56.6 0.042	61.3 0.046	80

Table 3.3: PR70f Maximum and Minimum Flow Rates (cc/s) with Super and Standard Pump Sizes

480-960 sizes

480	520	560	600	640	720	800	880	960		
169.7 0.126	174.4 0.130	179.1 0.133	183.8 0.137	188.5 0.140	198.0 0.147	207.4 0.154	216.8 0.161	226.3 0.168		960
160.3 0.119	165.0 0.123	169.7 0.126	174.4 0.130	179.1 0.133	188.5 0.140	198.0 0.147	207.4 0.154	216.8 0.161		880
150.8 0.112	155.5 0.116	160.3 0.119	165.0 0.123	169.7 0.126	179.1 0.133	188.5 0.140	198.0 0.147	207.4 0.154		800
141.4 0.105	146.1 0.109	150.8 0.112	155.5 0.116	160.3 0.119	169.7 0.126	179.1 0.133	188.5 0.140	198.0 0.147		720
132.0 0.098	136.7 0.102	141.4 0.105	146.1 0.109	150.8 0.112	160.3 0.119	169.7 0.126	179.1 0.133	188.5 0.140		640
127.3 0.095	132.0 0.098	136.7 0.102	141.4 0.105	146.1 0.109	155.5 0.116	165.0 0.123	174.4 0.130	183.8 0.137		600
122.6 0.091	127.3 0.095	132.0 0.098	136.7 0.102	141.4 0.105	150.8 0.112	160.3 0.119	169.7 0.126	179.1 0.133		560
117.8 0.088	122.6 0.091	127.3 0.095	132.0 0.098	136.7 0.102	146.1 0.109	155.5 0.116	165.0 0.123	174.4 0.130		520
113.1 0.084	117.8 0.088	122.6 0.091	127.3 0.095	132.0 0.098	141.4 0.105	150.8 0.112	160.3 0.119	169.7 0.126		480
108.4 0.081	113.1 0.084	117.8 0.088	122.6 0.091	127.3 0.095	136.7 0.102	146.1 0.109	155.5 0.116	165.0 0.123		440
103.7 0.077	108.4 0.081	113.1 0.084	117.8 0.088	122.6 0.091	132.0 0.098	141.4 0.105	150.8 0.112	160.3 0.119		400
99.0 0.074	103.7 0.077	108.4 0.081	113.1 0.084	117.8 0.088	127.3 0.095	136.7 0.102	146.1 0.109	155.5 0.116		360
94.3 0.070	99.0 0.074	103.7 0.077	108.4 0.081	113.1 0.084	122.6 0.091	132.0 0.098	141.4 0.105	150.8 0.112		320
91.9 0.068	96.6 0.072	101.3 0.075	106.1 0.079	110.8 0.082	120.2 0.089	129.6 0.096	139.1 0.103	148.5 0.110		300
89.6 0.067	94.3 0.070	99.0 0.074	103.7 0.077	108.4 0.081	117.8 0.088	127.3 0.095	136.7 0.102	146.1 0.109		280
87.2 0.065	91.9 0.068	96.6 0.072	101.3 0.075	106.1 0.079	115.5 0.086	124.9 0.093	134.3 0.100	143.8 0.107		260
84.8 0.063	89.6 0.067	94.3 0.070	99.0 0.074	103.7 0.077	113.1 0.084	122.6 0.091	132.0 0.098	141.4 0.105		240
82.5 0.061	87.2 0.065	91.9 0.068	96.6 0.072	101.3 0.075	110.8 0.082	120.2 0.089	129.6 0.096	139.1 0.103		220
80.1 0.060	84.8 0.063	89.6 0.067	94.3 0.070	99.0 0.074	108.4 0.081	117.8 0.088	127.3 0.095	136.7 0.102		200
77.8 0.058	82.5 0.061	87.2 0.065	91.9 0.068	96.6 0.072	106.1 0.079	115.5 0.086	124.9 0.093	134.3 0.100		180
75.4 0.056	80.1 0.060	84.8 0.063	89.6 0.067	94.3 0.070	103.7 0.077	113.1 0.084	122.6 0.091	132.0 0.098		160
73.1 0.054	77.8 0.058	82.5 0.061	87.2 0.065	91.9 0.068	101.3 0.075	110.8 0.082	120.2 0.089	129.6 0.096		140
70.7 0.053	75.4 0.056	80.1 0.060	84.8 0.063	89.6 0.067	99.0 0.074	108.4 0.081	117.8 0.088	127.3 0.095		120
68.3 0.051	73.1 0.054	77.8 0.058	82.5 0.061	87.2 0.065	96.6 0.072	106.1 0.079	115.5 0.086	124.9 0.093		100
66.0 0.049	70.7 0.053	75.4 0.056	80.1 0.060	84.8 0.063	94.3 0.070	103.7 0.077	113.1 0.084	122.6 0.091		80

Appendix D - Small Amount Shot Mode Dispensing

The PR70F now has the capability to consistently dispense very small shot amounts when the pumps are preloaded at the metering tube entrance or paused within the meter tube. This new capability is available in systems using the system software version 1.01.006, released in April of 2018, or later. Dispensing small shot amounts eliminates the need for the machine to re-load the pump after every dispense, saving time between dispenses and making the product more suitable for automation applications.

To implement this feature, the “Auto-Load Pump After Dispense” option on the Advanced #4 screen must be turned ON. To save re-load time after each dispense, it is recommended that the “Dispense Pause/ Stepping ON” option is turned on also, as shown below in FIG. 24.

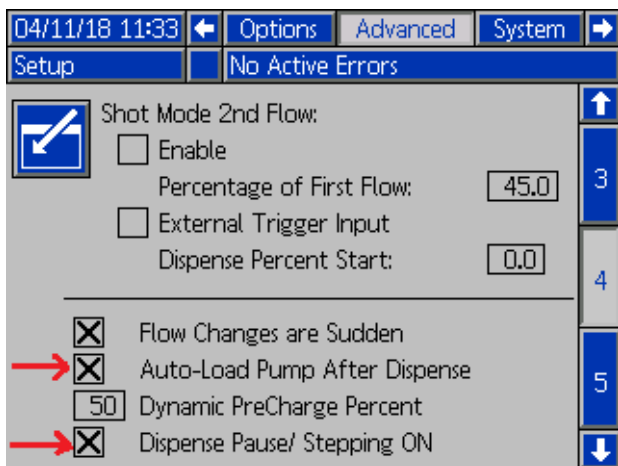



FIG. 24

One example of when this feature might be used is when the pumps are in the full retract position and a very small dispense amount is selected.

If the user requests a dispense (via the footswitch or by pressing the dispense  key), the request will be rejected and a “B10X-A Small Shot Request” error will be generated, as shown in FIG. 25.

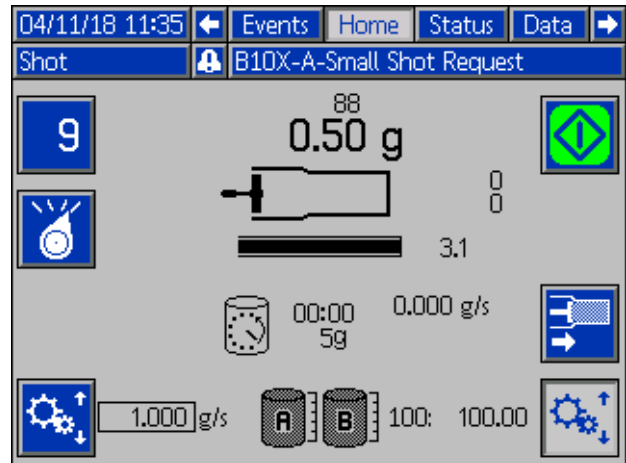





FIG. 25

To correct this situation, the user must request for the

pumps to load by either pressing the  soft-key, or by activating the “INTERRUPT – CAN –REQ” input on the PLC interface. The PR70F will respond to the request by extending the pumps to the metering tube entrance, and stalling the pumps to pressure. The process is complete when the pump re-load key transitions

from  to , and the run screen appears as shown in FIG. 26.

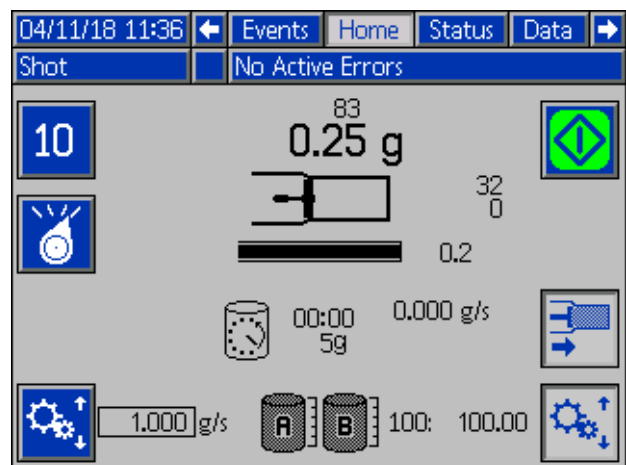

FIG. 26

similar to FIG. 27 shown below.

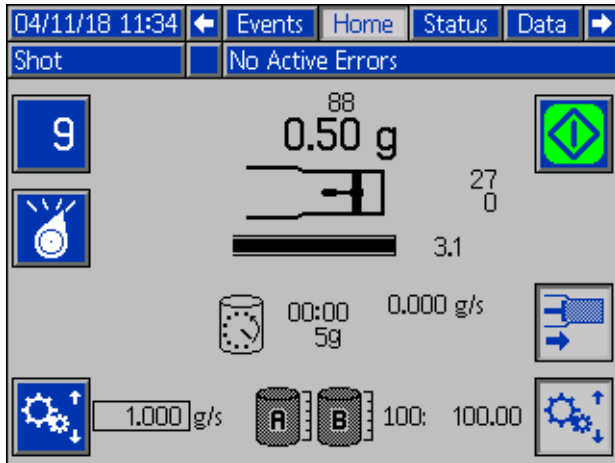

FIG. 27

After completing a sequence of dispenses, the user can navigate to the right and view the small amount dispense sequence which will be recorded on the “Events” run screen.

#	Date	Time	Code-Class-Event
1	04/11/18	16:04:05	EKDX-R-Shot 0.25g, 0.11sec, 0.000g/s
2	04/11/18	16:03:58	EJDX-R-Aborted Early Shot 0.40g, 0.16sec, 0.000g/s
3	04/11/18	16:03:41	EKDX-R-Shot 0.45g, 0.18sec, 0.000g/s
4	04/11/18	16:03:36	EKDX-R-Shot 2.45g, 1.30sec, 0.000g/s
5	04/11/18	16:03:33	EKDX-R-Shot 2.45g, 1.04sec, 0.000g/s
6	04/11/18	16:03:28	EKDX-R-Shot 0.85g, 0.49sec, 0.000g/s
7	04/11/18	16:03:27	EKDX-R-Shot 0.85g, 0.34sec, 0.000g/s

FIG. 28

If a dispense requires a travel distance beyond the end of the metering tube, the machine will retract from the current “Paused” position and start the dispense at the tube entrance automatically.

At the end of a dispense sequence, the user can



re-load the pump by pressing the reload (“”) softkey, or activating the “INTERRUPT – CAN –REQ” input in the PLC interface. After the pumps re-load, the run screen will appear similar to FIG. 29, and the described sequence of small amount dispenses can be repeated.

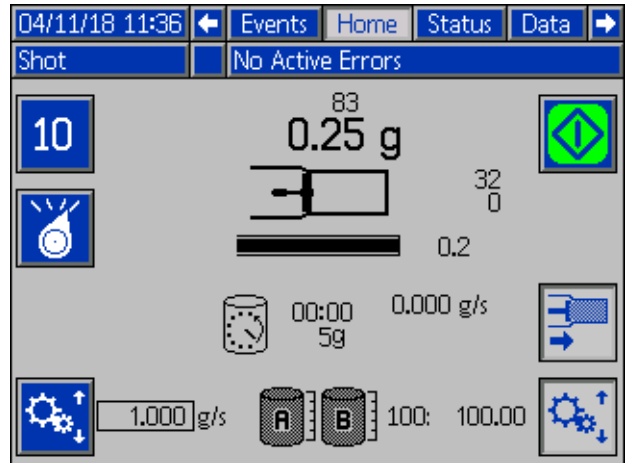

FIG. 29

Small Amount Dispensing Tips

To properly dispense consistent small shot amounts, the following steps are recommended:

1. When dispensing small amounts, stalling the pump to a pressure is critical. Verify enough restriction exists for the stalling pump when the system performs a dispense at the flow selected. The stalling pump at the dispense end is the bigger of the two pumps, or the A pump (Left pump when viewing the front of the machine) if both pumps are the same size. If not enough restriction exists for the stalling pump at the selected flow rate, install a thinner hose between the pump outlet and the dispense valve.
2. Typically the first dispense at the metering tube entrance is dump dispense (discard the material), because this amount may not be consistent with the remaining dispenses in the metering tube. If the dispense amounts are very small, the second dispense may be a dump dispense as well.

3. Verify the flow set point (displayed by the bottom left soft key on the home run screen) for a small dispense has been executed by the machine previously. If not, execute a long dump shot dispense at the selected flow rate to enable the machine to record the correct pressure for stalling at that flow rate. The stall pressure for the selected flow rate equals the pressure monitored while the pump is traveling at the selected flow rate, multiplied by the "Dynamic PreCharge Percent" entered on the Advanced #4 screen.
4. As the dispense amount approaches nearly 0 grams, the over-dispense amount may become significant due to accumulation effects of the hoses between the pump outputs and the dispense valve. For instance, a 640:640 PR70f with 10' of hoses installed with a requested dispense amount of 0.25 grams will typically deliver over 0.5 grams of material. Therefore, for small dispense applications, shorter and thinner hoses are preferred.
5. The slower the flow rate selected, the more consistent the small dispense amount becomes, and the less over dispense amount will be produced.

Test Results, Small Amount Dispenses

Some small dispense consistency tests were performed on a PR70F machine, which was not properly configured for small amount dispensing. The pumps and air motor were large, and the hoses were too thick and long. The machine still produced fairly consistent shot amounts approaching 1/10 of the original minimum shot amount from a full retract position. The retract position minimum shot amount is provided on the Calibration #3 screen. FIG. 30 shows a screen shot from the PR70F used for this test, including the retract starting position minimum shot amount.

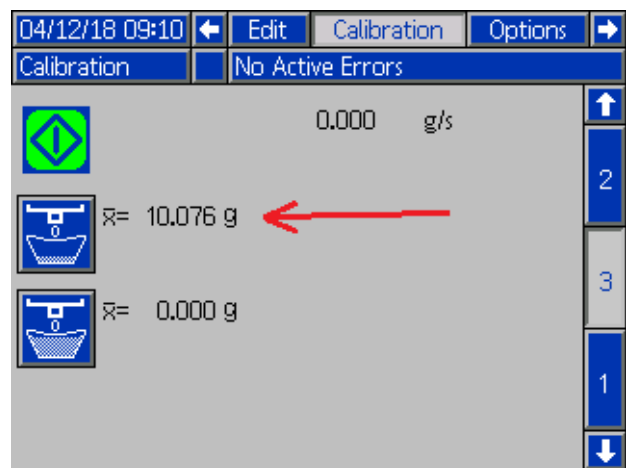

FIG. 30

The PR70F used for this test was configured with the following hardware:

A & B Pumps: 640 mm² for both

Hoses: 10 feet length

Air Motor: Large 4 in. diameter

To summarize, better test results would have been achieved if the recommended steps listed above were implemented (shorter thinner hoses, smaller pumps and air motor, etc.).

Results

As indicated in the following data, there were over dispense amounts delivered for all requested amounts. However, the machine produced fairly accurate results down to ~ 1/10 of the original minimum shot amount. The machine amount was NOT calibrated using the 2 point method outlined in the **Dispense Amount Accuracy** section on page 56. Therefore, the actual dispense amounts were consistently off target slightly.

Requested Size 1/4 Original Minimum Size (2.5 Grams):

Pumps	640:640 mm2
Air Motor	4 inch diameter
Previous Minimum Shot Size	10.064 grams
Requested Amount	2.5 grams
% of Original Minimum Size	24.85%
Nominal Size (g)	1.79 grams
Tol. Max. (+)	0.56 (20%)
Tol. Min. (-)	0.56 (20%)
USL	3.35
LSL	2.23
Std. Dev.	0.075
Mean	2.792
Maximum	2.930
Minimum	2.610
Cp	2.485
Cpkl	2.485
Cpku	2.485
Cpk	2.485
Cpk Target	1.330

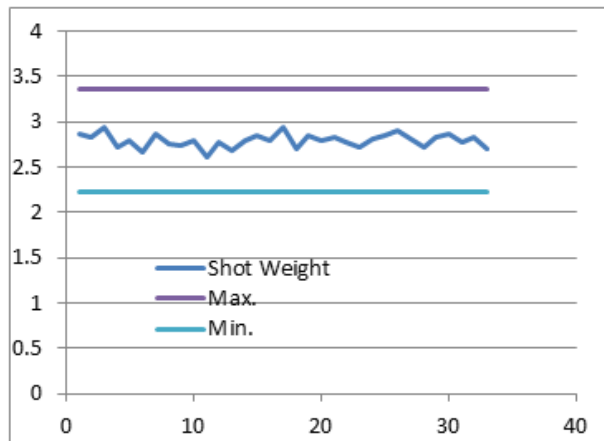

Requested Size 1/10 Original Minimum Size (1.0 Grams):

Pumps	640:640 mm2
Air Motor	4 inch diameter
Previous Minimum Shot Size	10.064 grams
Requested Amount	1 gram
% of Original Minimum Size	9.93937%
Nominal Size (g)	1.30 grams
Tol. Max. (+)	0.26 (20%)
Tol. Min. (-)	0.26 (20%)
USL	1.56
LSL	1.04
Std. Dev.	0.069
Mean	1.297
Maximum	1.410
Minimum	1.180
Cp	1.245
Cpkl	1.245
Cpku	1.245
Cpk	1.245
Cpk Target	1.330

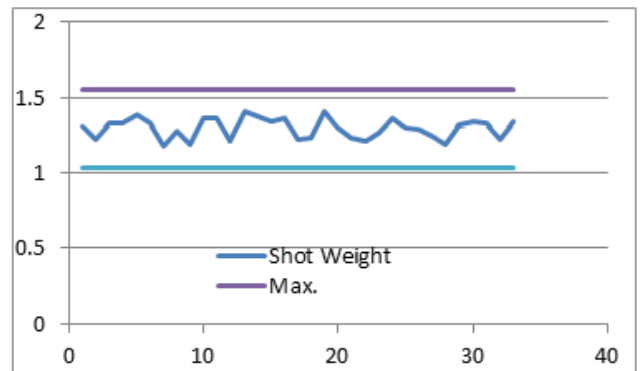

Requested Size 1/20 Original Minimum Size (0.5 Grams):

Pumps	640:640 mm2
Air Motor	4 inch diameter
Previous Minimum Shot Size	10.061 grams
Requested Amount	0.5 grams
% of Original Minimum Size	4.97%
Nominal Size (g)	0.80 grams
Tol. Max. (+)	0.16 (20%)
Tol. Min. (-)	0.16 (20%)
USL	0.96
LSL	0.64
Std. Dev.	0.048
Mean	0.802
Maximum	0.900
Minimum	0.730
Cp	1.105
CpkI	1.105
Cpku	1.105
Cpk	1.105
Cpk Target	1.330

Requested Size 1/40 Original Minimum Size (0.25 Grams):

Pumps	640:640 mm2
Air Motor	4 inch diameter
Previous Minimum Shot Size	10.061 grams
Requested Amount	0.25 grams
% of Original Minimum Size	2.48%
Nominal Size (g)	0.55 grams
Tol. Max. (+)	0.11 (20%)
Tol. Min. (-)	0.11 (20%)
USL	0.66
LSL	0.44
Std. Dev.	0.065
Mean	0.554
Maximum	0.690
Minimum	0.450
Cp	0.570
CpkI	0.570
Cpku	0.570
Cpk	0.570
Cpk Target	1.330

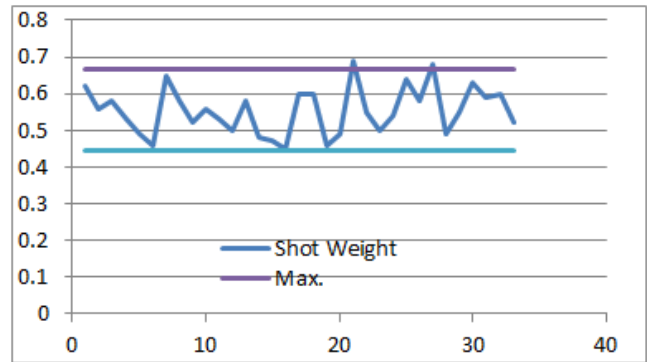
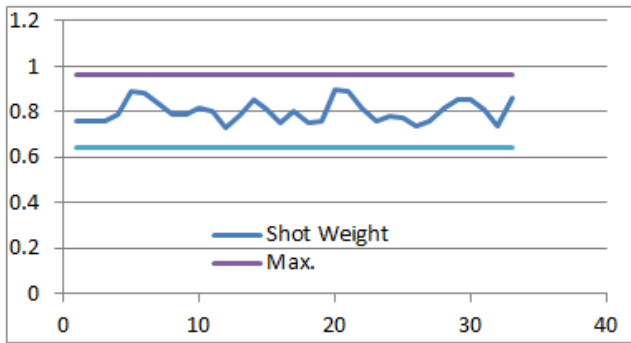

Electrical Schematics

NOTE: Fluid Control Module #2 sections apply only to models with optional features purchased.

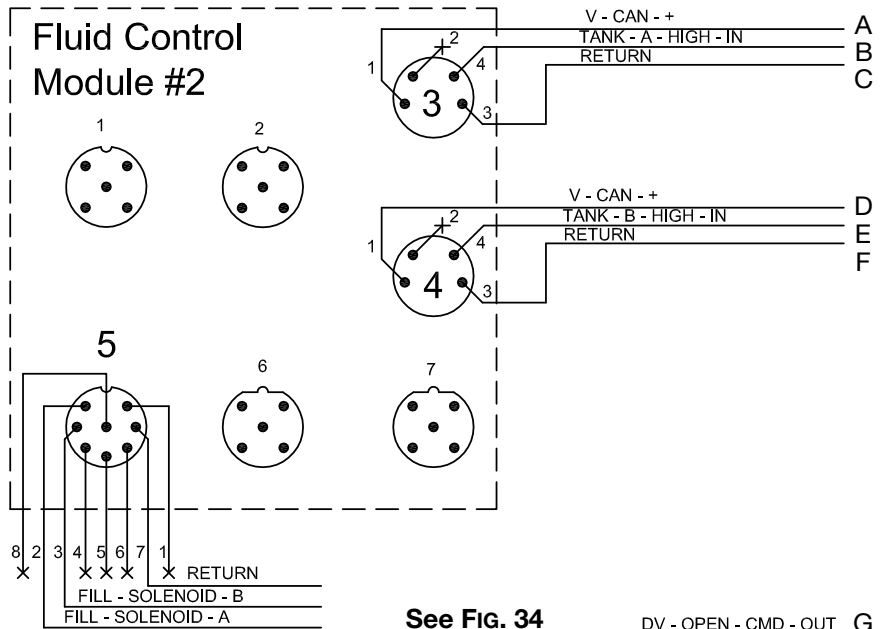

NOTE ALL CONNECTIONS SHOWN
LOOKING AT THE CABLE END CONNECTOR

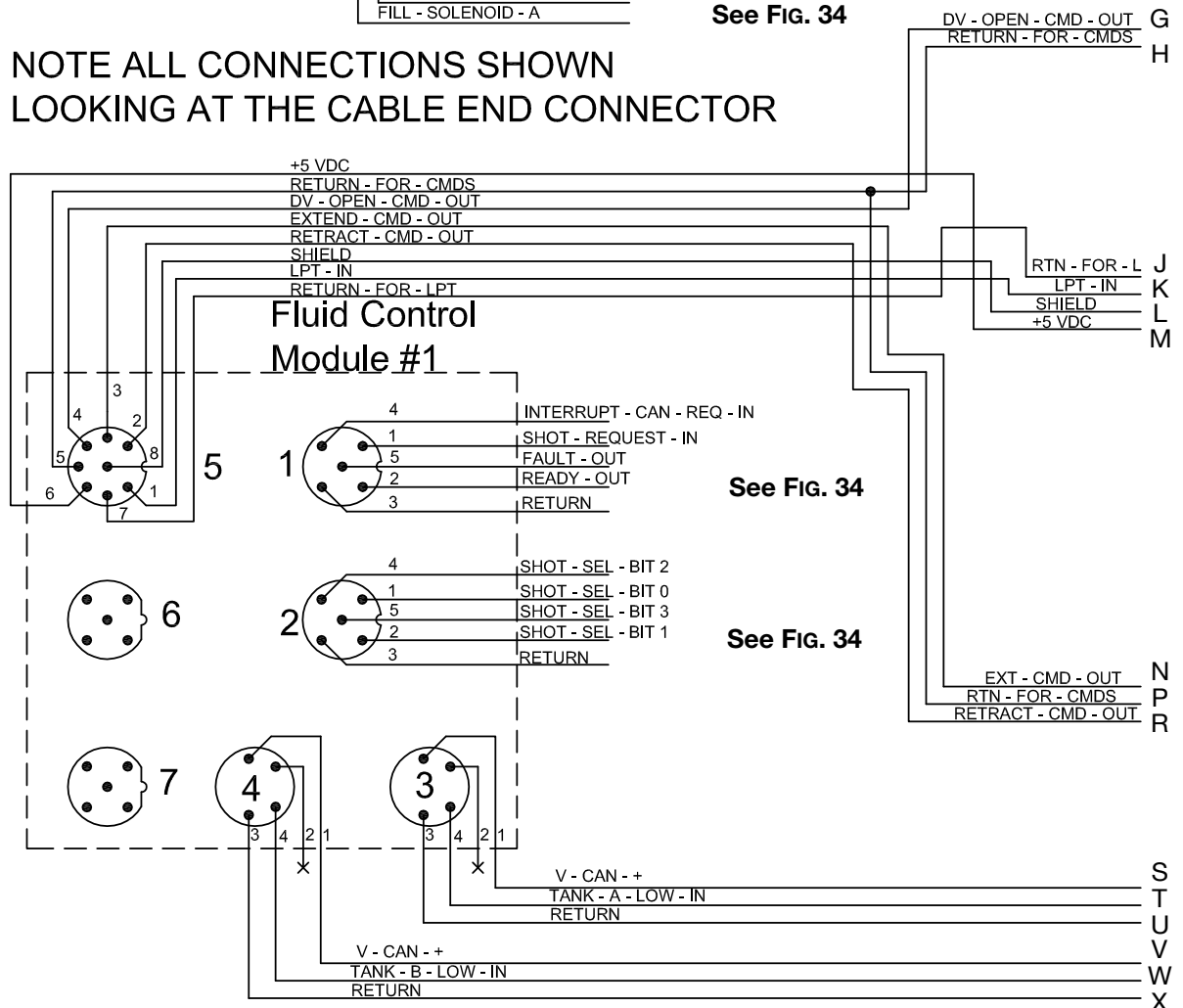

FIG. 31: Electrical Schematic - Page 1

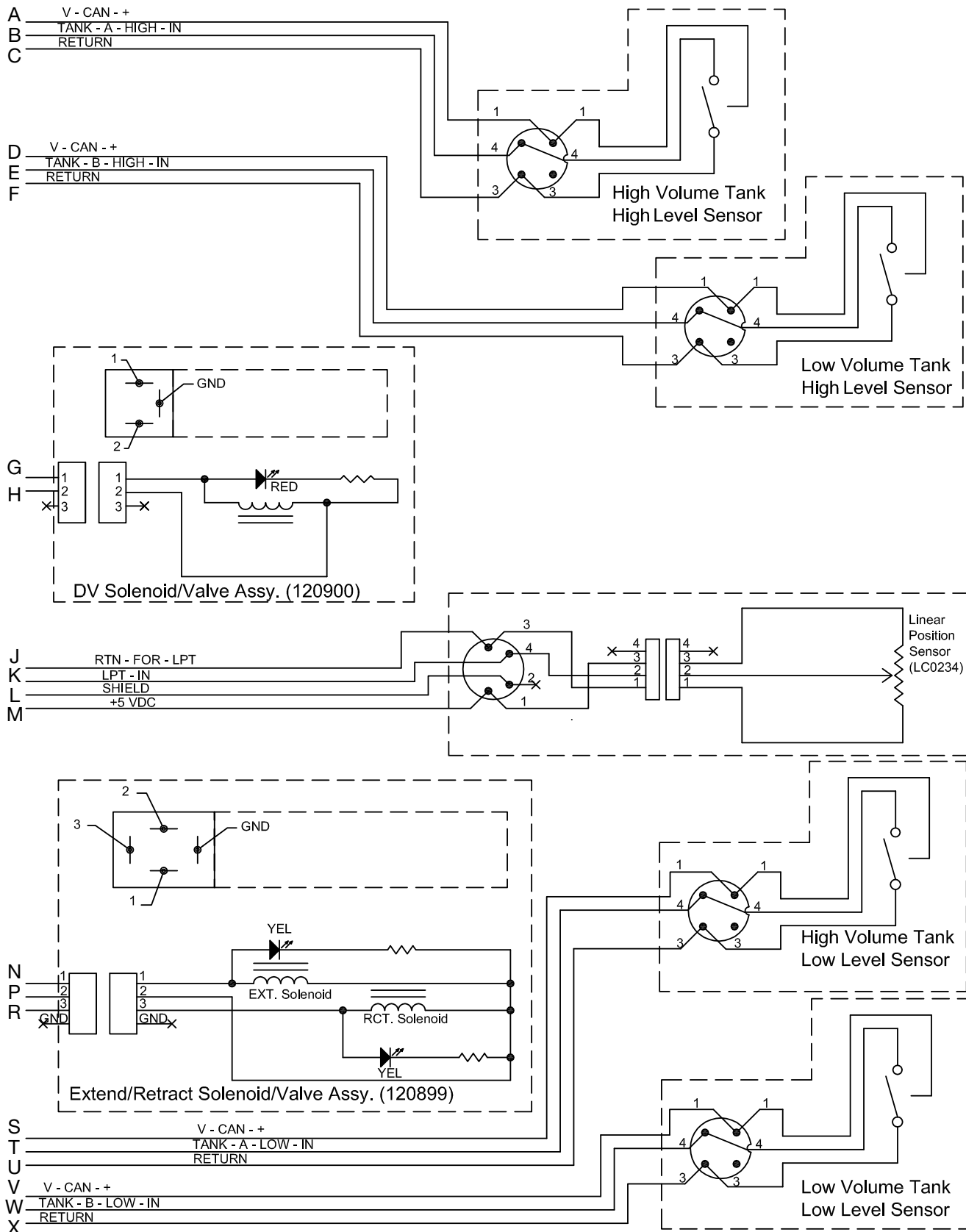

Fig. 32: Electrical Schematic - Page 2

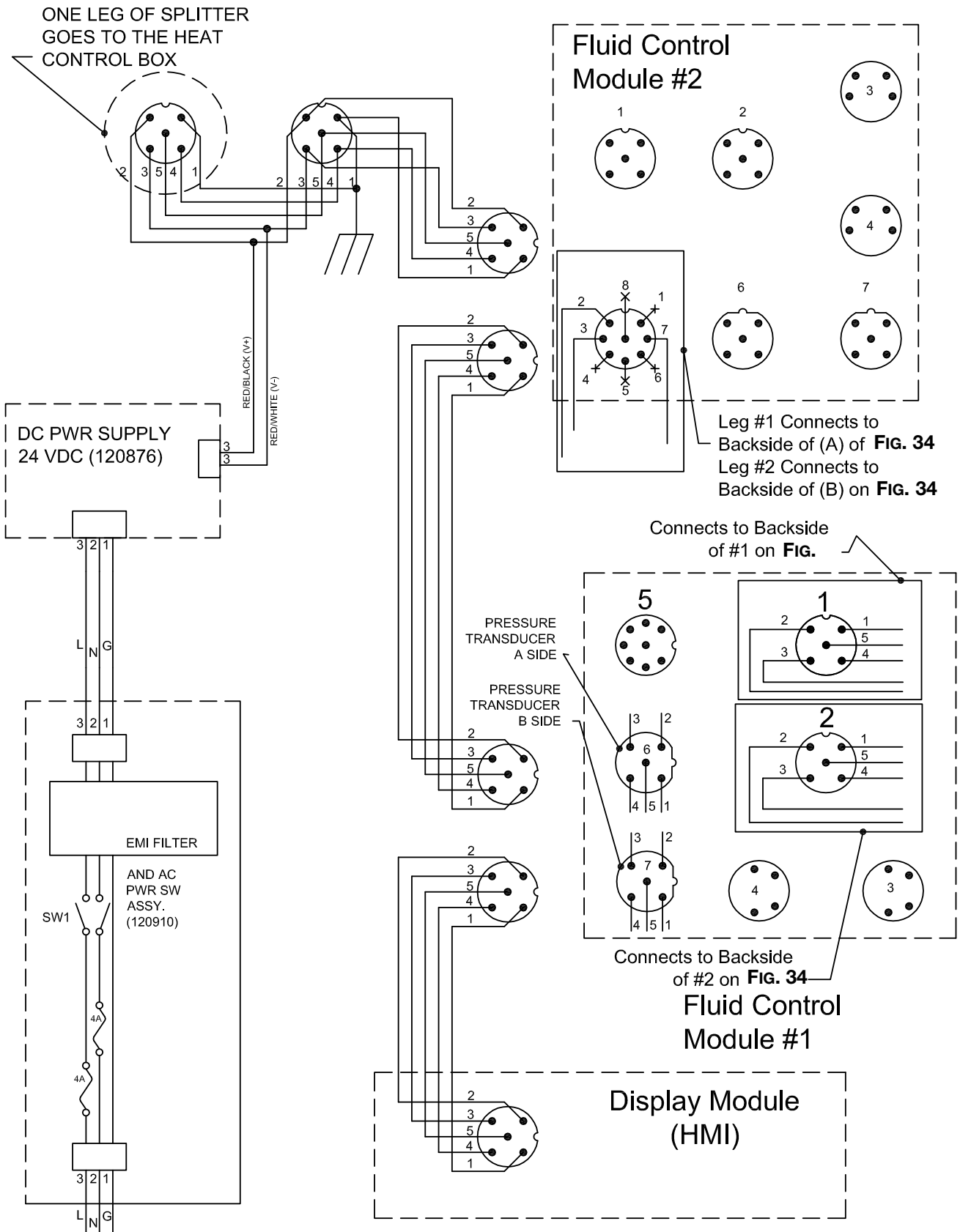

FIG. 33: Electrical Schematic - Page 3

NOTE: See PR70 operation manual for Optional External Control Interface instructions.

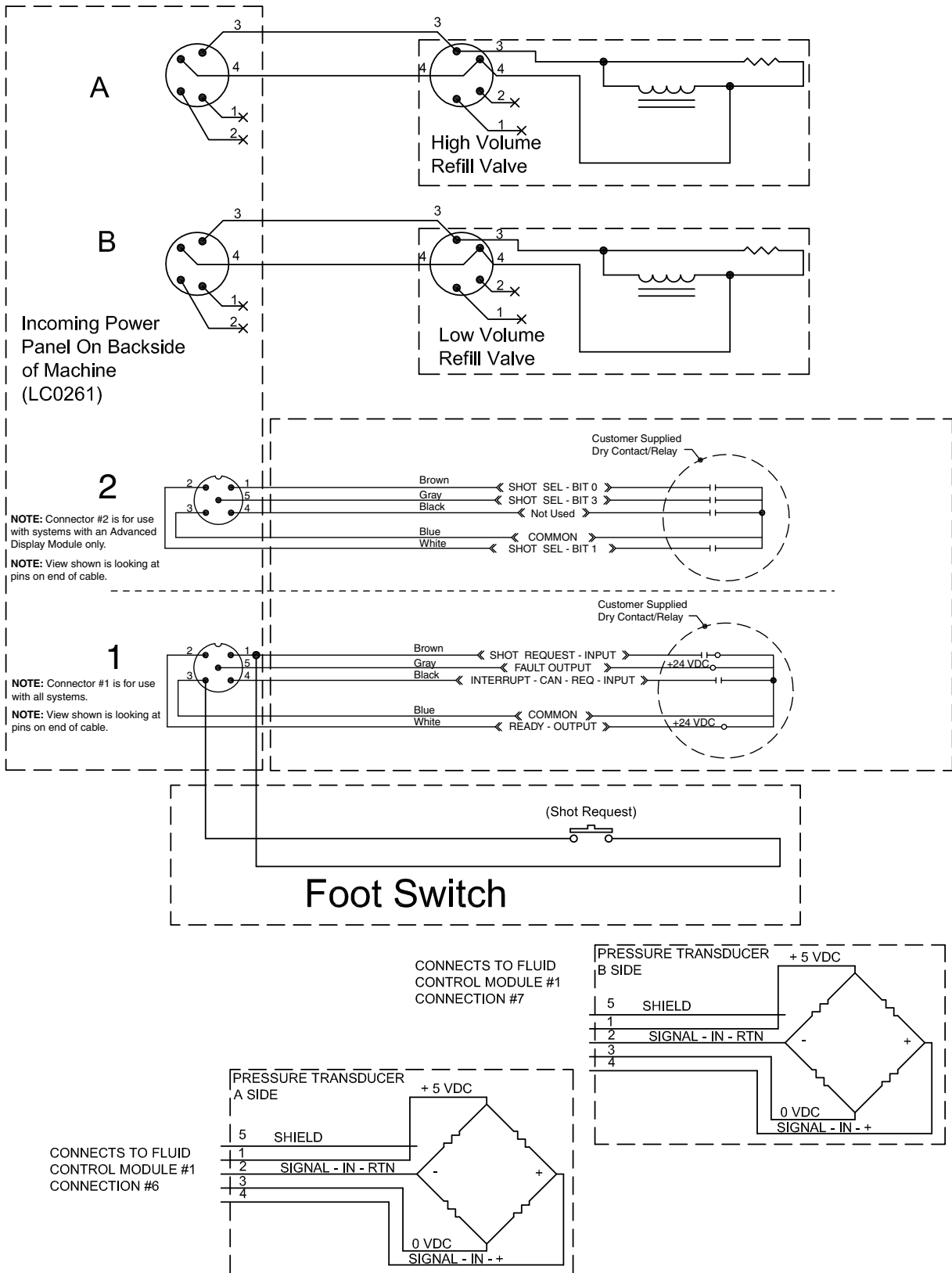

FIG. 34: Electrical Schematic - Page 4

Kits

Mixer and Shroud Options

Part	Description
LC0063	Mixer, 3/16 in. (6.5 mm) x 32, 10 Mixers with shroud
LC0057	Mixer, 1/4 in. (6.5 mm) x 24, 10 Mixers with shroud
LC0058	Mixer, 3/8 in. (9.8 mm) x 24, 10 Mixers with shroud
LC0059	Mixer, 3/8 in. (9.8 mm) x 36, 10 Mixers with shroud
LC0060	Mixer, 3/8 in. (9.8 mm) Combo, 10 Mixers with shroud
LC0061	Mixer, 3/16 in. (4.8 mm) x 32 Luer Lock, 10 Mixers with shroud
LC0062	Mixer, 1/4 in. (6.5 mm) x 24 Luer Lock, 10 Mixers with shroud
LC0077	Mixer, 3/16 in. (4.8 mm) x 32, 50 Mixers
LC0078	Mixer, 1/4 in. (6.5 mm) x 24, 50 Mixers
LC0079	Mixer, 3/8 in. (9.8 mm) x 24, 50 Mixers
LC0080	Mixer, 3/8 in. (9.8 mm) x 36, 50 Mixers
LC0081	Mixer, 3/8 in. (9.8 mm) combo, 50 Mixers
LC0083	Mixer, 1/4 in. (6.5 mm) x 24 Luer Lock, 50 Mixers
LC0082	Mixer, 3/16 in. (4.8 mm) x 32 Luer Lock, 50 Mixers
LC0084	Mixer, 3/16 in. (4.8 mm) x 32, 250 Mixers
LC0085	Mixer, 1/4 in. (6.5 mm) x 24, 250 Mixers
LC0086	Mixer, 3/8 in. (9.8 mm) x 24, 250 Mixers
LC0087	Mixer, 3/8 in. (9.8 mm) x 36, 250 Mixers
LC0088	Mixer, 3/8 in. (9.8 mm) combo, 250 Mixers
LC0089	Mixer, 3/16 in. (4.8 mm) x 32 Luer Lock, 250 Mixers
LC0090	Mixer, 1/4 in. (6.5 mm) x 24 Luer Lock, 250 Mixers

Tank Accessories

See the PR70™ and PR70v™ Feed Systems Instructions-Parts Manual for the parts included with each kit. See Related Manuals.

External Control Interface Connection Kit

Part	Description
LC0008	Cord, I/O Interface and Splitter (Connector #1)
120997	Cord, Shot SEL (Connector #2)

MD2 Valve Kits

See MD2 Dispense Valve instruction manual referenced at the beginning of this manual for installation instructions or for more information.

Part	Description
255217	MD2, kit rebuild, air cylinder
255218	MD2, kit rebuild, back-end of wet section (no needle or seat)
255219	MD2, Soft Seat rebuild, needle and nose
255220	MD2, convert Soft Seat nose to Hard Seat (Hard Seat rebuild), needle and nose

Machine Rebuild Kits

See the PR70™ and PR70v™ Repair - Parts manual referenced at the beginning of this manual for parts included in each kit.

Part	Description
LC0091	3.0 in. Air Cylinder rebuild kit
LC0092	4.5 in. Air Cylinder rebuild kit
LC0093	Check Valve rebuild kit, Stainless Steel Ball
LC0318	Check Valve rebuild kit, Carbide Ball
LC0094	Rear Pump Seal rebuild kit
16H378	LCM Screen Protector

Light Tower Accessory

Part	Description
255468*	Light Tower Kit

* only available with ADM models.

PR70™ ISO Lube Recirculation Kit

Part	Description
25U135	PR70™ ISO Lube Recirculation Kit - With 230 VAC Pump
25U137	PR70™ ISO Lube Recirculation Kit - Without Pump
25U199	PR70™ ISO Lube Recirculation Kit - With 120 VAC Pump

Dimensions

PR70f with On-board Tanks (Fixed Ratio Chassis)

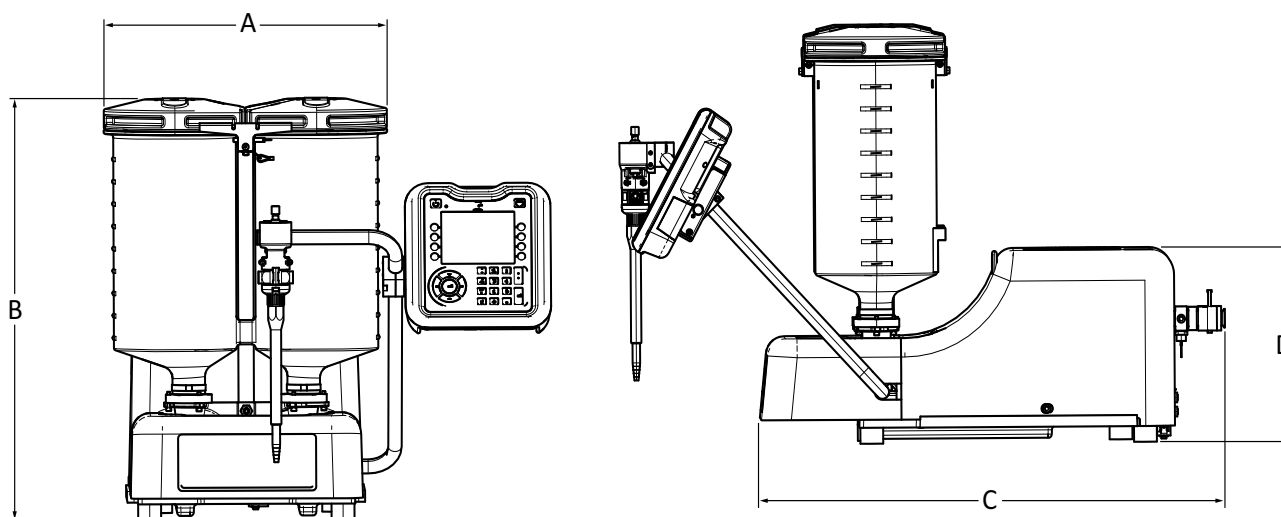
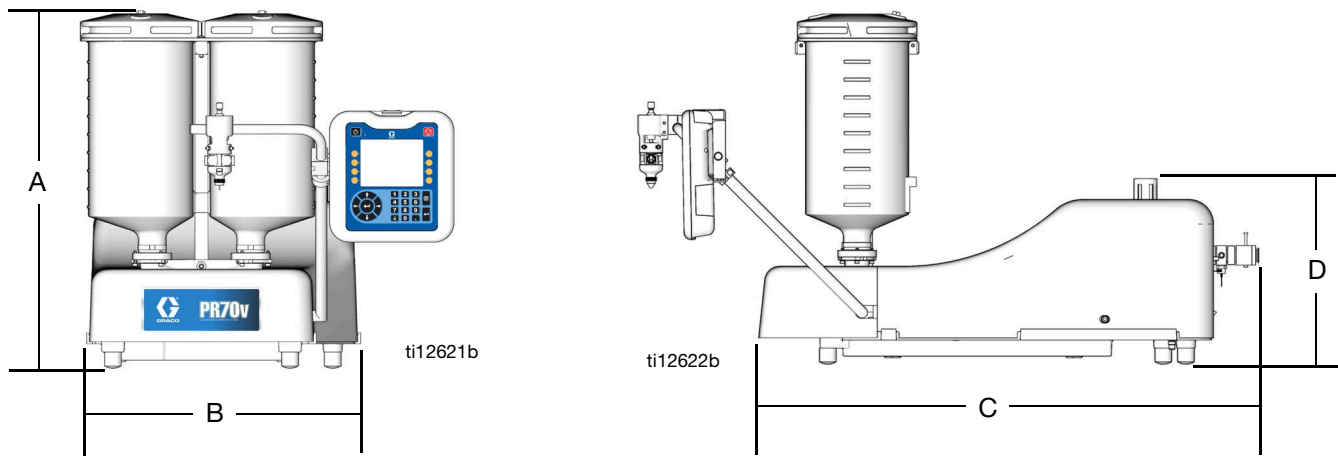

FIG. 35: PR70f Front and Side Views (with PE tanks)

A typical PR70f with the standard on-board twin 8 liter polyethylene tanks			
Dimension	In. (mm)	Dimension	In. (mm)
A (width)	18.49 (469.6)	C (depth)	30.62 (777.7)
B (height)	26.39 (670.3)	D (height in back)	13.39 (240.1)
A typical PR70f with the standard on-board twin 7.5 liter stainless steel tanks			
A (width)	15.5 (393.7)	C (depth)	30.62 (777.7)
B (height)	27.37 (695.2)	D (height in back)	13.39 (240.1)

Machine with On-Board Tanks



PR70

Ref	† Assembly Dimensions, in. (mm)				
	Polyethylene Tanks		◆ Stainless Steel Tanks		
	No Agitators	With Agitators	3 L	7.5 L, No Agitators	7.5 L, with Agitators
A	26.4 (670)	38.6 (980)	28.2 (716)	38.2 (970)	39.9 (1013)
B	18.5 (470)	18.5 (470)	15.5 (394)	15.5 (394)	15.5 (394)
C	30.6 (778)	30.6 (778)	30.6 (778)	30.6 (778)	30.6 (778)
D	12.0 (305)	12.0 (305)	12.0 (305)	12.0 (305)	12.0 (305)

PR70v

Ref	† Assembly Dimensions, in. (mm)				
	Polyethylene Tanks		◆ Stainless Steel Tanks		
	No Agitators	With Agitators	3 L, No Agitators	7.5 L, No Agitators	7.5 L, with Agitators
A	30.0 (762)	39.4 (1001)	29.0 (737)	39.0 (991)	40.6 (1031)
B	20.9 (531)	20.9 (531)	20.9 (531)	20.9 (531)	20.9 (531)
C	38.6 (980)	38.6 (980)	38.6 (980)	38.6 (980)	38.6 (980)
D	12.7 (323)	12.7 (323)	12.7 (323)	12.7 (323)	12.7 (323)

† Assembly dimensions listed are maximum for all assemblies under the given title.

◆ On-board stainless steel tank dimensions include ball valves and vacuum de-gas in maximum height calculation.

Machine with Off-Board Tanks

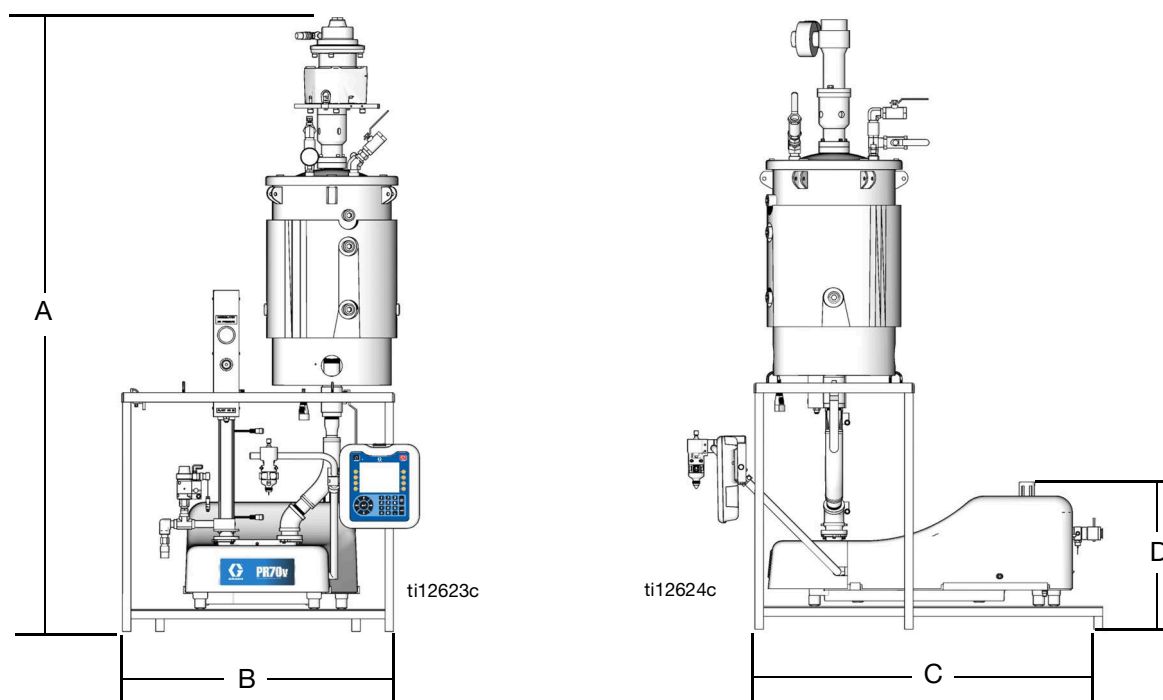

PR70

Ref	† Assembly Dimensions, in. (mm)			
	30 L Tank		60 L Tank	
	No Agitators	With Agitators	No Agitators	With Agitators
A	75.7 (1923)	83.4 (2118)	64.9 (1648)	89.5 (2273)
B	32.1 (815)	32.1 (815)	32.1 (815)	32.1 (815)
C	29.3 (236)	29.3 (236)	29.3 (236)	29.3 (236)
D	14.6 (371)	14.6 (371)	14.6 (371)	14.6 (371)

PR70v

Ref	† Assembly Dimensions, in. (mm)			
	30 L Tank		60 L Tank	
	No Agitators	With Agitators	No Agitators	With Agitators
A	75.7 (1923)	83.4 (2118)	64.9 (1648)	89.5 (2273)
B	32.1 (815)	32.1 (815)	32.1 (815)	32.1 (815)
C	40.1 (1019)	40.1 (1019)	40.1 (1019)	40.1 (1019)
D	15.4 (391)	15.4 (391)	15.4 (391)	15.4 (391)

Technical Data

PR70f		
	US	Metric
Maximum fluid working pressure	3000 psi	20.7 MPa, 207 bar
Maximum air input pressure	100 psi	0.7 MPa, 7 bar
Compressed air (varies with cycle times)	Less than 10 scfm typical	Less than 0.2835 m ³ /minute
Metering pump effective area (per side)	0.124 to 1.49 in. ²	80 to 960 mm ²
Small air cylinder effective area	7.07 in. ²	4560 mm ²
Large air cylinder effective area	15.9 in. ²	10260 mm ²
Maximum stroke length	1.50 in.	38.1 mm
Minimum stroke length	0.23 in.	5.8 mm
Volume per cycle*	0.12 to 4.3 in. ³	2 to 70 cc
Pump cycles per 1 L (0.26 gal)*	14.3 to 500 cycles (varies by piston size)	
Ratios (fixed)	1:1 to 12:1 (depending on cylinders selected)	
Ratios (variable)	1:1 to 24:1 (with much more adjustment capabilities)	
Sound Pressure Level**	82 dBA	
Maximum operating temperature (Do not exceed the lowest maximum depending on the diaphragm, ball, and seat used in your pump.)		
Nylon pistons	160°F	70°C
UHMWPE pistons or PE tanks	120°F	50°C
Power Requirements		
Electrical Power	100-240 V 50/60 Hz, 1 phase for machine - 80 watts 208-240 V 50/60 Hz, 1 phase for heat - 11 kW max 120 or 240 VAC 50/60 Hz 1 phase for on-board agitators, 80 watts 240 VAC 50/60 Hz 1 phase for off-board agitators, 600 watts	
Inlet/Outlet Sizes		
Air inlet size	1/4 in. npt(f)	
Pump fluid outlet size	-03, -04, -06, -08, or -12 JIC fittings for 3/16 in. (4.8 mm), 1/4 in. (6.4 mm), 3/8 in. (9.5 mm), 1/2 in. (12.7 mm), 3/4 in. (19.1 mm) hoses	
Materials of Construction		
Wetted parts	303/304, 17-4 PH, hard chrome, Chromex™, carbide, chemical resistant O-rings, PTFE, nylon, UHMWPE	
Weight		
Typical with two 7.5 L tanks	120 lb.	55 kg
Typical with two 60 L tanks	330 lb.	150 kg
Notes		
* Startup pressures and displacement per cycle may vary based on suction condition, discharge head, air pressure, and fluid type.		
** Sound pressure measured at typical operator station for machine mounted dispense valve.		
Gast® is registered trademark of Gast Manufacturing.		
Inhibisol® is a registered trademark of Penetone Corp.		

California Proposition 65

CALIFORNIA RESIDENTS

 **WARNING:** Cancer and reproductive harm – www.P65warnings.ca.gov.

Graco Standard Warranty

Graco warrants all equipment referenced in this document which is manufactured by Graco and bearing its name to be free from defects in material and workmanship on the date of sale to the original purchaser for use. With the exception of any special, extended, or limited warranty published by Graco, Graco will, for a period of twelve months from the date of sale, repair or replace any part of the equipment determined by Graco to be defective. This warranty applies only when the equipment is installed, operated and maintained in accordance with Graco's written recommendations.

This warranty does not cover, and Graco shall not be liable for general wear and tear, or any malfunction, damage or wear caused by faulty installation, misapplication, abrasion, corrosion, inadequate or improper maintenance, negligence, accident, tampering, or substitution of non-Graco component parts. Nor shall Graco be liable for malfunction, damage or wear caused by the incompatibility of Graco equipment with structures, accessories, equipment or materials not supplied by Graco, or the improper design, manufacture, installation, operation or maintenance of structures, accessories, equipment or materials not supplied by Graco.

This warranty is conditioned upon the prepaid return of the equipment claimed to be defective to an authorized Graco distributor for verification of the claimed defect. If the claimed defect is verified, Graco will repair or replace free of charge any defective parts. The equipment will be returned to the original purchaser transportation prepaid. If inspection of the equipment does not disclose any defect in material or workmanship, repairs will be made at a reasonable charge, which charges may include the costs of parts, labor, and transportation.

THIS WARRANTY IS EXCLUSIVE, AND IS IN LIEU OF ANY OTHER WARRANTIES, EXPRESS OR IMPLIED, INCLUDING BUT NOT LIMITED TO WARRANTY OF MERCHANTABILITY OR WARRANTY OF FITNESS FOR A PARTICULAR PURPOSE.

Graco's sole obligation and buyer's sole remedy for any breach of warranty shall be as set forth above. The buyer agrees that no other remedy (including, but not limited to, incidental or consequential damages for lost profits, lost sales, injury to person or property, or any other incidental or consequential loss) shall be available. Any action for breach of warranty must be brought within two (2) years of the date of sale.

GRACO MAKES NO WARRANTY, AND DISCLAIMS ALL IMPLIED WARRANTIES OF MERCHANTABILITY AND FITNESS FOR A PARTICULAR PURPOSE, IN CONNECTION WITH ACCESSORIES, EQUIPMENT, MATERIALS OR COMPONENTS SOLD BUT NOT MANUFACTURED BY GRACO. These items sold, but not manufactured by Graco (such as electric motors, switches, hose, etc.), are subject to the warranty, if any, of their manufacturer. Graco will provide purchaser with reasonable assistance in making any claim for breach of these warranties.

In no event will Graco be liable for indirect, incidental, special or consequential damages resulting from Graco supplying equipment hereunder, or the furnishing, performance, or use of any products or other goods sold hereto, whether due to a breach of contract, breach of warranty, the negligence of Graco, or otherwise.

FOR GRACO CANADA CUSTOMERS

The Parties acknowledge that they have required that the present document, as well as all documents, notices and legal proceedings entered into, given or instituted pursuant hereto or relating directly or indirectly hereto, be drawn up in English. Les parties reconnaissent avoir convenu que la rédaction du présente document sera en Anglais, ainsi que tous documents, avis et procédures judiciaires exécutés, donnés ou intentés, à la suite de ou en rapport, directement ou indirectement, avec les procédures concernées.

Graco Information

Sealant and Adhesive Dispensing Equipment

For the latest information about Graco products, visit www.graco.com.

For patent information, see www.graco.com/patents.

TO PLACE AN ORDER, contact your Graco distributor, go to www.graco.com, or call to identify the nearest distributor.

If calling from the USA: 1-800-746-1334

If calling from outside the USA: 0-1-330-966-3000

All written and visual data contained in this document reflects the latest product information available at the time of publication. Graco reserves the right to make changes at any time without notice.

Original instructions. This manual contains English. MM 334984

Graco Headquarters: Minneapolis

International Offices: Belgium, China, Japan, Korea

GRACO INC. AND SUBSIDIARIES • P.O. BOX 1441 • MINNEAPOLIS MN 55440-1441 • USA
Copyright 2016, Graco Inc. All Graco manufacturing locations are registered to ISO 9001.

www.graco.com

Revision R, February 2025