

# XM<sup>TM</sup> Plural-Component Sprayers

312359U

EN

For spraying two-component epoxy and urethane protective coatings in hazardous and non-hazardous locations.

For professional use only.



## Important Safety Instructions

Read all warnings and instructions in this manual and in all related manuals before using the equipment. Save all instructions.

See page 7 for model information and agency approvals.  
See page 104 for maximum working pressure.

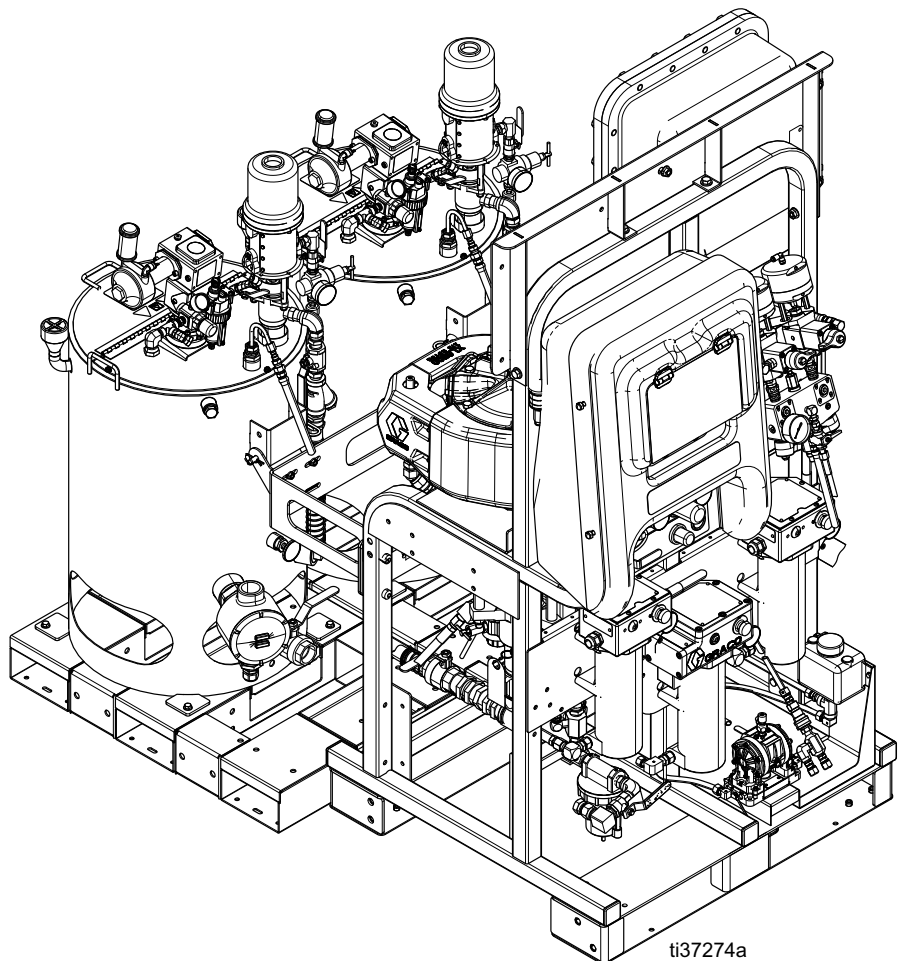

# Contents

<b>Related Manuals</b> .....	<b>3</b>	<b>Pressure Relief Procedure</b> .....	<b>44</b>
<b>Warnings</b> .....	<b>4</b>	<b>Flush</b> .....	<b>45</b>
<b>Important Isocyanate (ISO) Information</b> .....	<b>7</b>	Flush Mixed Manifold, Hose, and Spray Gun ..	45
Isocyanate Conditions .....	7	Flush Hoppers .....	46
Keep Components A and B Separate .....	7	Empty and Flush Entire System (new sprayer or end of job) .....	49
Moisture Sensitivity of Isocyanates .....	8	<b>Park Fluid Pump Rods</b> .....	<b>51</b>
Changing Materials .....	8	<b>Shutdown Entire System</b> .....	<b>51</b>
<b>Models</b> .....	<b>9</b>	<b>System Verification</b> .....	<b>52</b>
<b>Approvals</b> .....	<b>11</b>	Mix and Integration Tests .....	52
<b>Overview</b> .....	<b>16</b>	Pump and Metering Test .....	52
Usage .....	16	Batch Dispense or Ratio Test .....	55
<b>Location</b> .....	<b>16</b>	<b>Download Data from USB</b> .....	<b>57</b>
.....	16	USB Logs .....	57
<b>Proper Lifting of Sprayer</b> .....	<b>17</b>	Download Setup .....	57
<b>Initial System Setup</b> .....	<b>18</b>	Download Procedure .....	57
<b>Component Identification</b> .....	<b>19</b>	<b>Maintenance</b> .....	<b>59</b>
Typical Setup: 25 Gallon Double Wall Hopper with Recirculation .....	19	Filters .....	59
Typical Setup: 25 Gallon Double Wall Hopper with Recirculation (Back and Side Views) .....	20	Seals .....	59
Fluid Control Assembly .....	22	Cleaning Procedure .....	59
Junction Box .....	23	Hopper .....	60
Air Controls .....	24	Feed Pumps .....	61
User Interface .....	25	Agitators .....	61
Hopper Assembly .....	26	<b>XM Setup and Tips</b> .....	<b>62</b>
<b>Setup</b> .....	<b>28</b>	LED Diagnostic Information .....	63
Grounding .....	28	<b>Troubleshooting</b> .....	<b>64</b>
Connect Power Source .....	28	<b>Accessories and Kits</b> .....	<b>74</b>
Wiring Diagram .....	30	<b>Appendix A</b> .....	<b>76</b>
Connect Explosion-Proof Heaters .....	31	User Interface Display .....	76
Connect Air Supply .....	31	Change a Setting .....	76
Connect Fluid Hose Assembly .....	32	Setup Mode Screens .....	77
Adjust Packing Nuts .....	32	Operator Command Mode Screens .....	85
<b>Basic Operation</b> .....	<b>33</b>	Automatically Displayed Screens .....	93
Power On .....	33	<b>Appendix B</b> .....	<b>94</b>
Power On .....	33	Metering Diagrams .....	94
Adjust Ratio and Setup .....	33	<b>Appendix C</b> .....	<b>96</b>
View Alarms .....	33	Power Cord Guidelines .....	96
Set System Settings (Optional) .....	34	<b>Dimensions</b> .....	<b>97</b>
Set Maintenance Parameters (Optional) .....	35	XM System Dimensions without Hoppers (Non-Hazardous Locations) .....	97
Set Sprayer Limits (Optional) .....	36	XM System Dimensions without Hoppers (Hazardous Locations) .....	98
<b>Prime</b> .....	<b>37</b>	10-Gallon Rear Mount Steel Tank .....	99
Prime A and B Fluids .....	37	25-Gallon Rear Mount Steel Tank .....	100
Prime Solvent Flush Pump .....	39	System Dimensions with Hoppers .....	101
<b>Recirculate</b> .....	<b>40</b>	System Dimensions with Hoppers .....	102
With Heat .....	40	<b>Pump Performance Charts</b> .....	<b>103</b>
Without Heat .....	40	<b>Technical Specifications</b> .....	<b>104</b>
Heat Fluid .....	41	<b>California Proposition 65</b> .....	<b>105</b>
<b>Spray</b> .....	<b>42</b>	<b>Graco Standard Warranty</b> .....	<b>106</b>
<b>Adjust B Machine Outlet Restriction</b> .....	<b>43</b>		



## Related Manuals







Manuals are available at [www.graco.com](http://www.graco.com).











Manual in English	Description
313289	XM Plural-Component Sprayers Repair-Parts
313292	XM Plural-Component OEM Sprayers Instructions-Parts
311762	Xtreme® Displacement Pumps Instructions-Parts
3A5423	XL6500 and XL3400 Air Motor Instructions-Parts
3A6110	Double Wall Stainless Steel Lined Hopper Kit Instructions-Parts
3A2954	Viscon® HF Heater Instructions-Parts
312145	XTR™ 5 and XTR™ 7 Spray Guns Instructions-Parts
3A4032	Xtreme Duty™ and Agitator Instructions-Parts
312794	Merkur® Pump Assembly Instructions-Parts
406699	7-Gallon Plastic, 10-Gallon Stainless Steel Hopper Installation Kit Instructions-Parts
406739	Desiccant Kit Instructions-Parts
406690	Caster Kit Instructions-Parts
406691	Hose Rack Kit Instructions-Parts
313258	Electric Heated Hose Power Supply Kit Instructions-Parts
313259	Hopper or Hose Heat Circulation Kit Instructions-Parts
312770	Lower Strainer and Valve Kit Instructions-Parts
312749	XM Mix Manifold Kit Instructions-Parts
313293	Alternator Conversion Kits Instructions-Parts
313342	Dosing Valve Repair Kit Instructions-Parts
313343	High Flow Severe Duty Shutoff Check Valve Repair Kit Instructions-Parts
307044	Feed Pump Instructions-Parts
3A7670	Remote Recirculation Manifold Instructions-Parts
3A7523	Junction Box for XP and XM Proportioners Instructions-Parts
3A7524	Xtreme-Wrap Electric Heated Hose Instructions-Parts
3A5313	Xtreme-Wrap Water Heated Hose Parts

# Warnings

The following warnings are for the setup, use, grounding, maintenance, and repair of this equipment. The exclamation point symbol alerts you to a general warning and the hazard symbols refer to procedure-specific risks. When these symbols appear in the body of this manual or on warning labels, refer back to these Warnings. Product-specific hazard symbols and warnings not covered in this section may appear throughout the body of this manual where applicable.

 <span style="font-size: 2em; font-weight: bold; margin-left: 10px;">DANGER</span>	
 	<p><b>SEVERE ELECTRIC SHOCK HAZARD</b></p> <p>This equipment can be powered by more than 240 V. Contact with this voltage will cause death or serious injury.</p> <ul style="list-style-type: none"> <li>• Turn off and disconnect power at main switch before disconnecting any cables and before servicing equipment.</li> <li>• This equipment must be grounded. Connect only to grounded power source.</li> <li>• All electrical wiring must be done by a qualified electrician and comply with all local codes and regulations.</li> </ul>

 <span style="font-size: 2em; font-weight: bold; margin-left: 10px;">WARNING</span>	
   	<p><b>FIRE AND EXPLOSION HAZARD</b></p> <p>Flammable fumes, such as solvent and paint fumes, in <b>work area</b> can ignite or explode. Paint or solvent flowing through the equipment can cause static sparking. To help prevent fire and explosion:</p> <ul style="list-style-type: none"> <li>• Use equipment only in well-ventilated area.</li> <li>• Eliminate all ignition sources; such as pilot lights, cigarettes, portable electric lamps, and plastic drop cloths (potential static sparking).</li> <li>• Ground all equipment in the work area. See <b>Grounding</b> instructions.</li> <li>• Never spray or flush solvent at high pressure.</li> <li>• Keep work area free of debris, including solvent, rags and gasoline.</li> <li>• Do not plug or unplug power cords, or turn power or light switches on or off when flammable fumes are present.</li> <li>• Use only grounded hoses.</li> <li>• Hold gun firmly to side of grounded pail when triggering into pail. Do not use pail liners unless they are anti-static or conductive.</li> <li>• <b>Stop operation immediately</b> if static sparking occurs or you feel a shock. Do not use equipment until you identify and correct the problem.</li> <li>• Keep a working fire extinguisher in the work area.</li> <li>• Do not connect USB device in explosive atmospheres.</li> </ul>
	<p><b>SPECIAL CONDITIONS FOR SAFE USE</b></p> <ul style="list-style-type: none"> <li>• To prevent the risk of electrostatic sparking, the equipment's non-metallic parts must be cleaned only with a damp cloth.</li> <li>• Flamepath joints are not for repair. Contact the manufacturer.</li> <li>• Special fasteners for securing equipment covers shall have a minimum yield strength of 1000 MPa, and be corrosion resistant and sized M8x1.5x30.</li> </ul>

 <h1 style="margin: 0;">WARNING</h1>	
 	<p><b>INTRINSIC SAFETY</b></p> <p>Intrinsically safe equipment that is installed improperly or connected to non-intrinsically safe equipment will create a hazardous condition and can cause fire, explosion, or electric shock. Follow local regulations and the following safety requirements.</p> <ul style="list-style-type: none"> <li>• Only models with model number XM_D00, XM_N_ __, or XM_E_ __, utilizing the air-driven alternator are approved for installation in a Hazardous (explosive atmosphere) Location - see <b>Approvals</b>, 11. Only the models stated above meet all local safety fire codes including NFPA 33, NEC 500 and 516, and OSHA 1910.107. To help prevent fire and explosion:             <ul style="list-style-type: none"> <li>- Do not install equipment approved only for a non-hazardous location in a hazardous location. See model ID label for intrinsic safety rating of your model.</li> <li>- Do not substitute system components as this may impair intrinsic safety.</li> </ul> </li> <li>• Equipment that comes in contact with the intrinsically safe terminals must be rated for Intrinsic Safety. This includes DC voltage meters, ohmmeters, cables, and connections. Remove the unit from the hazardous area when troubleshooting.</li> <li>• Do not connect, download, or remove USB device unless unit is removed from the hazardous (explosive atmosphere) location.</li> <li>• If explosion-proof heaters are used, ensure wiring, wiring connections, switches, and electrical distribution panel all meet flame-proof (explosion-proof) requirements.</li> </ul>
    	<p><b>SKIN INJECTION HAZARD</b></p> <p>High-pressure fluid from gun, hose leaks, or ruptured components will pierce skin. This may look like just a cut, but it is a serious injury that can result in amputation. <b>Get immediate surgical treatment.</b></p> <ul style="list-style-type: none"> <li>• Engage trigger lock when not dispensing.</li> <li>• Do not spray without tip guard and trigger guard installed.</li> <li>• Engage trigger lock when not spraying.</li> <li>• Do not point gun at anyone or at any part of the body.</li> <li>• Do not put your hand over the spray tip.</li> <li>• Do not stop or deflect leaks with your hand, body, glove, or rag.</li> <li>• Follow the <b>Pressure Relief Procedure</b> when you stop spraying and before cleaning, checking, or servicing equipment.</li> <li>• Tighten all fluid connections before operating the equipment.</li> <li>• Check hoses and couplings daily. Replace worn or damaged parts immediately.</li> </ul>
 	<p><b>MOVING PARTS HAZARD</b></p> <p>Moving parts can pinch, cut or amputate fingers and other body parts.</p> <ul style="list-style-type: none"> <li>• Keep clear of moving parts.</li> <li>• Do not operate equipment with protective guards or covers removed.</li> <li>• Equipment can start without warning. Before checking, moving, or servicing equipment, follow the <b>Pressure Relief Procedure</b> and disconnect all power sources.</li> </ul>

# **WARNING**



## **EQUIPMENT MISUSE HAZARD**

Misuse can cause death or serious injury.

- Do not operate the unit when fatigued or under the influence of drugs or alcohol.
- Do not exceed the maximum working pressure or temperature rating of the lowest rated system component. See **Technical Specifications** in all equipment manuals.
- Use fluids and solvents that are compatible with equipment wetted parts. See **Technical Specifications** in all equipment manuals. Read fluid and solvent manufacturer's warnings. For complete information about your material, request Safety Data Sheets (SDSs) from distributor or retailer.
- Do not leave the work area while equipment is energized or under pressure.
- Turn off all equipment and follow the **Pressure Relief Procedure** when equipment is not in use.
- Check equipment daily. Repair or replace worn or damaged parts immediately with genuine manufacturer's replacement parts only.
- Do not alter or modify equipment. Alterations or modifications may void agency approvals and create safety hazards.
- Make sure all equipment is rated and approved for the environment in which you are using it.
- Use equipment only for its intended purpose. Call your distributor for information.
- Route hoses and cables away from traffic areas, sharp edges, moving parts, and hot surfaces.
- Do not kink or over bend hoses or use hoses to pull equipment.
- Keep children and animals away from work area.
- Comply with all applicable safety regulations.



## **TOXIC FLUID OR FUMES HAZARD**

Toxic fluids or fumes can cause serious injury or death if splashed in the eyes or on skin, inhaled or swallowed.

- Read Safety Data Sheets (SDSs) for handling instructions and to know the specific hazards of the fluids you are using, including the effects of long-term exposure.
- When spraying, servicing equipment, or when in the work area, always keep work area well-ventilated and always wear appropriate personal protective equipment. See **Personal Protective Equipment** warnings in this manual.
- Store hazardous fluid in approved containers, and dispose of it according to applicable guidelines.



## **BURN HAZARD**

Equipment surfaces and fluid that is heated can become very hot during operation. To avoid severe burns:

- Do not touch hot fluid or equipment.



## **PERSONAL PROTECTIVE EQUIPMENT**

Always wear appropriate personal protective equipment and cover all skin when spraying, servicing equipment, or when in the work area. Protective equipment helps prevent serious injury, including long-term exposure; inhalation of toxic fumes, mists or vapors; allergic reaction; burns; eye injury and hearing loss. This protective equipment includes but is not limited to:

- A properly fitting respirator, which may include a supplied-air respirator, chemically impermeable gloves, protective clothing and foot coverings as recommended by the fluid manufacturer and local regulatory authority.
- Protective eyewear and hearing protection.

# Important Isocyanate (ISO) Information

Isocyanates (ISO) are catalysts used in two component materials.

## Isocyanate Conditions



Spraying or dispensing fluids that contain isocyanates creates potentially harmful mists, vapors, and atomized particulates.

- Read and understand the fluid manufacturer's warnings and Safety Data Sheets (SDSs) to know specific hazards and precautions related to isocyanates.
- Use of isocyanates involves potentially hazardous procedures. Do not spray with this equipment unless you are trained, qualified, and have read and understood the information in this manual and in the fluid manufacturer's application instructions and SDSs.
- Use of incorrectly maintained or mis-adjusted equipment may result in improperly cured material. Equipment must be carefully maintained and adjusted according to instructions in the manual.
- To prevent inhalation of isocyanate mists, vapors, and atomized particulates, everyone in the work area must wear appropriate respiratory protection. Always wear a properly fitting respirator, which may include a supplied-air respirator. Ventilate the work area according to instructions in the fluid manufacturer's SDSs.
- Avoid all skin contact with isocyanates. Everyone in the work area must wear chemically impermeable gloves, protective clothing and foot coverings as recommended by the fluid manufacturer and local regulatory authority. Follow all fluid manufacturer recommendations, including those regarding handling of contaminated clothing. After spraying, wash hands and face before eating or drinking.

## Keep Components A and B Separate



Cross-contamination can result in cured material in fluid lines which could cause serious injury or damage equipment. To prevent cross-contamination:

- **Never** interchange component A and component B wetted parts.
- Never use solvent on one side if it has been contaminated from the other side.

## Moisture Sensitivity of Isocyanates

Exposure to moisture (such as humidity) will cause ISO to partially cure, forming small, hard, abrasive crystal that become suspended in the fluid. Eventually a film will form on the surface and the ISO will begin to gel, increasing in viscosity.

### NOTICE

Partially cured ISO will reduce performance and the life of all wetted parts.

- Always use a sealed container with a desiccant dryer in the vent, or a nitrogen atmosphere. **Never** store ISO in an open container.
- Keep the ISO pump wet cup or reservoir (if installed) filled with appropriate lubricant. The lubricant creates a barrier between the ISO and the atmosphere.
- Use only moisture-proof hoses compatible with ISO.
- Never use reclaimed solvents, which may contain moisture. Always keep solvent containers closed when not in use.
- Always lubricate threaded parts with an appropriate lubricant when reassembling.

**NOTE:** The amount of film formation and rate of crystallization varies depending on the blend of ISO, the humidity, and the temperature.

## Changing Materials



### NOTICE

Changing the material types used in your equipment requires special attention to avoid equipment damage and downtime.

- When changing materials, flush the equipment multiple times to ensure it is thoroughly clean.
- Always clean the fluid inlet strainers after flushing.
- Check with your material manufacturer for chemical compatibility.
- When changing between epoxies and urethanes or polyureas, disassemble and clean all fluid components and change hoses. Epoxies often have amines on the B (hardener) side. Polyureas often have amines on the B (resin) side.



# Models

				
<p>XM sprayers are not approved for use in hazardous locations unless the base model, all accessories, all kits, and all wiring meet local, state, and national codes.</p>				

Check the identification plate (ID) for the 6-digit part number of the sprayer. Use the following matrix to define the construction of the sprayer, based on the six digits. For example, Part XM1L00 represents an XM Plural-Component sprayer (XM); 5200 psi pump set with pump filters (1); wall power supply, no heaters, no junction box, and is not approved for hazardous areas (L).

**NOTE:** Some configurations in the following matrix cannot be built. Consult with distributor or Graco representative.

To order replacement parts, see Parts section the XM Plural-Component Sprayer Repair-Parts manual 313289. The digits in the matrix do not correspond to the Ref. numbers in the Parts drawings and lists.

**Table 1: Hazardous Locations**

(See **Top Level Sprayer Approvals** on page 11)

First Two Digits	Third Digit		Fourth Digit				Fifth Digit		Sixth Digit		
			Control Power		Viscon HP Fluid Heaters		Feed System		Heated Hose		
Model	Pump Set (psi)	Remote Manifold	Intrinsically Safe Alternator XM_D00		Explosion Proof						0
					240V						
XM	5	XM50 (5200)	✓	N	✓			0		None	
	7	XM70 (6300)	✓	E	✓	✓					

**Table 2: Designed with Hazardous Location Approved Components**

(No Top Level Sprayer approval - individual component approvals listed in **Approvals**, page 11)

First Two Digits	Third Digit		Fourth Digit						Fifth Digit		Sixth Digit			
			Control Power		Viscon HF Fluid Heaters		Junction Box		Feed System		Heated Hose			
Model	Pump Set (psi)	Remote Manifold	Intrinsically Safe Alternator XM_D00		Explosion Proof		Explosion Proof						2	
					240V	480V	240V	480V						
XM	5	XM50 (5200)	✓	J	✓	✓		✓		2		25-Gallon Heated Skid		
	7	XM70 (6300)	✓	K	✓		✓		✓					1
												E		
												W		Water

**Table 3: Non-Hazardous Locations**







(No Top Level Sprayer approval - individual component approvals listed in **Component Level Approvals**, page 12)

First Two Digits	Third Digit			Fourth Digit						Fifth Digit		Sixth Digit		
	Model	Pump Set (psi)	Remote Manifold		Control Power		Viscon HF Fluid Heaters		Junction Box		Feed System		Heated Hose	
					Wall Power XM_A00	Intrinsically Safe Alternator XM_D00	240V	480V	240V	480V		Feed		
XM	1	XM50 (5200)		L	✓						0	None	0	None
	3	XM70 (6300)		M*	✓		✓		✓		1	10-Gallon Stainless Steel	W	Water
	5	XM50 (5200)	✓	H*	✓			✓		✓	2	25-Gallon Heated Skid	E	Electric
	7	XM70 (6300)	✓											

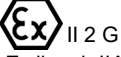

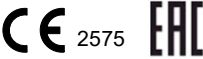
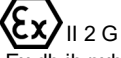
\* Uses Viscon High Flow (HF) Fluid Heaters.

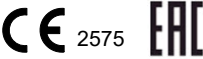



# Approvals

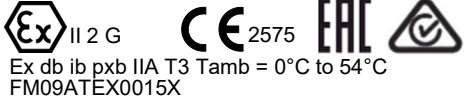

**Table 4: Top Level Sprayer Approvals**



Sprayer Model	Top Level Approvals
XM_N__	 <p>Ex ib pxb IIA T3 Gb Tamb = 0°C to 54°C FM09ATEX0015X</p>  <p>Ex i, Class I, Div 1, Group D, T3. Ta = 0°C to 54°C</p> 
XM_E__	 <p>Ex db ib pxb IIA T3 Tamb = 0°C to 54°C FM09ATEX0015X</p>  <p>Ex i, Class I, Div 1, Group D, T3. Ta = 0°C to 54°C</p> 
XM_P__ XM_F__	<p>System is intended for hazardous locations with the classification of Class I, Division 1, Group D T3 0°C to 54°C</p> 
XM_J__ XM_K__	<p>System is intended for hazardous locations with the classification of Class I, Division 1, Group D T3 0°C to 54°C</p>
XM_L__ XM_M__ XM_H__	

**Table 5: Component Level Approvals**









Control Power		North American Location		European Atmosphere		Approvals
Component	Description	Non-Hazardous	Hazardous Class I Division 1	Non-Explosive	Explosive	
XM_D00	Intrinsically Safe Alternator	✓	✓	✓	✓	 <p>Ex db ib pxb IIA T3 Tamb = 0°C to 54°C FM09ATEX0015X</p>  <p>APPROVED Intrinsically safe/ Sécurité intrinseque, Ex i, Class I, Div 1, Group D, T3. Ta = 0°C to 54°C</p>
XM_A00	Wall Power	✓		✓		

Primary Heaters		North American Location		European Atmosphere		Approvals
Component	Description	Non-Hazardous	Hazardous Class I Division 1	Non-Explosive	Explosive	
26C476	480V HF Ex	✓	✓	✓	✓	 <p>Intertek 5024314 Class I, Division 1, Groups C, D (T3) Ta = -20°C to 60°C</p>  <p>Certificate No: 18-KA4B0-0073X</p>
24W248	240V HF Ex	✓	✓	✓	✓	 <p>II 2 G Ex db IIB T4 Gb ITS14ATEX18155X IT521UKEX0367X</p> <p>IECEx Ratings EX db IIB T4 Gb IECEx Certificate No. IECEx ETL 14.0046X Ta = -20°C to 60°C</p>
24P016	240V HF Ordinary	✓		✓		
26C475	480V HF Ordinary	✓		✓		<p>Intertek 5024314 Certified to CAN/USA C22.2 No. 88 Conforms to UL STD499</p>



Junction Box		North American Location		Approvals	
Component	Description	Non-Hazardous	Hazardous Class I Division 1		
<b>Explosion Proof Electrical Enclosure</b>		✓	✓	 Class I, Division 1, Groups B, C, & D UL 1203/CSA C22.2 No. 25 & 30	
26C583	480V Explosion Proof Junction Box	✓	✓	Designed to Standards: UL 60079-0 UL 60079-25	
26C906	480V Explosion Proof Junction Box, Electric Hose Heat	✓	✓		
26C581	240V Explosion Proof Junction Box	✓	✓		
26C905	240V Explosion Proof Junction Box, Electric Hose Heat	✓	✓		
<b>Ordinary Location Electrical Enclosure</b>		✓		 Intertek 5024314 Conforms to UL STD 508A Certified to CAN/CSA C22.2 No. 286	
26C582	480V Junction Box	✓			
26C904	480V Junction Box, Electric Hose Heat	✓			
26C580	240V Junction Box	✓			
26C899	240V Junction Box, Electric Hose Heat	✓			

Solvent Pump		North American Location		European Atmospheres		Approvals
Component	Description	Non-Hazardous	Hazardous Class I Division 1	Non-Explosive	Explosive	
262392	Solvent Flush	✓	✓	✓	✓	  II 2 G Ex h T5 GbX

Approvals

Heated Hopper Assembly		North American Atmosphere		European Atmosphere		Approvals
Component	Description	Non-Hazardous	Hazardous Class I Division 1	Non-Explosive	Explosive	
25P239*	Immersion Heaters, 480V	✓	✓			 Class I, Division 1, Groups B, C, & D (T4)
25N577	Immersion Heaters, 240V	✓	✓	✓		 Class I, Division 1, Groups B, C, & D (T4)
25N584	5:1 Monark Pump	✓	✓	✓	✓	 II 1/2 G   Ex h IIb T2 Ga/Gb ETL23ATEX0276 TS21UKEX0322
25N588	Xtreme Duty Hopper Agitator	✓	✓	✓	✓	 II 1/2 G   Ex h IIb T4 Ga/Gb TS16ATEX100984X TS21UKEX0262X 0°C ≤ Ta ≤ 50°C

\*Selected if XM\_H\_ , XM\_K\_ are ordered. Will default to 240V immersion heater if XM\_M\_ , XM\_J\_ are ordered.

Heated Hose (sold separately)		North American Location Category		European Atmosphere Category		Approvals
Component	Description	Non-Hazardous	Hazardous Class I Division 1	Non-Explosive	Explosive	
See your water heated hose manual for complete list of part numbers	Water Jacketed	✓	✓	✓	✓	 
See your electric heated hose manual for complete list of part numbers and approvals	Electric	✓	✓	✓		 38141 Class I, Division 1

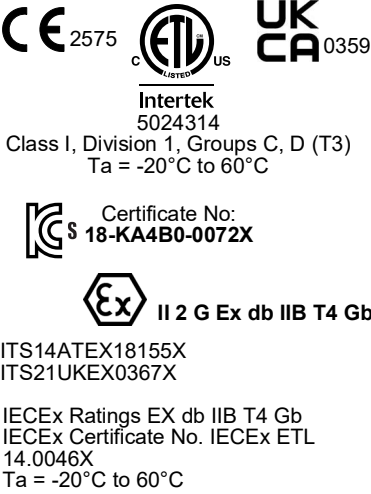
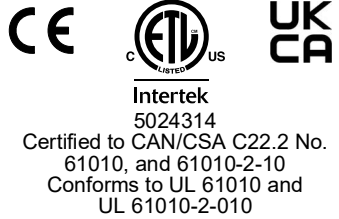
Hot Water Heater (water jacketed hose systems)		North American Location		European Atmosphere		Approvals
Component	Description	Non-Hazardous	Hazardous	Non-Explosive	Explosive	
245864	480V HP Hazardous	✓	✓	✓	✓	
245863	240V HP Hazardous	✓	✓	✓	✓	
245869	240V HP Non-Hazardous	✓		✓		
245870	480V HP Non-Hazardous	✓		✓		

Circ Pump (water jacketed hose systems)		North American Location Category		European Atmosphere Category		Approvals
Component	Description	Non-Hazardous	Hazardous	Non-Explosive	Explosive	
273093	Air Operated Diaphragm Pump	✓	✓	✓	✓	

# Overview



## Usage

XM plural-component sprayers can mix and spray most two-component epoxy and urethane protective coatings. When using quick-setting materials (less than 10 minute pot life) a remote mix manifold must be used.

The XM sprayer operates using compressed air pressure. XM plural-component sprayers are operated via the user interface, air controls, and fluid controls.



The hazardous location XM model variants feature an intrinsically safe alternator powered by a compressed air-fed turbine as a power supply. The alternator module working pressure must be set to 18 +/- 1 psi (12.6 +/- 10 kPa, 1.26 +/- 0.07 bar).

# Location

				
<p>XM sprayers are not approved for use in hazardous locations unless the base model, all accessories, all kits, and all wiring meet local, state, and national codes. See <b>Models</b>, page 9, to determine the appropriate location for your particular sprayer model.</p>				



# Proper Lifting of Sprayer

				
Follow instructions to avoid serious injury or damage to equipment. Never lift with the hopper(s) filled.				

**NOTICE**

To prevent spilling and to ensure even weight distribution, drain all fluid prior to lifting the proportioner.

## Lift Using a Forklift

Power must be off. Sprayer can be raised and moved using a forklift. Carefully lift the sprayer; make sure it balances evenly.

**NOTE:** If 25-gallon hoppers are installed, make sure the forklift arms extend across the entire unit. The forklift must approach from the front of the unit.

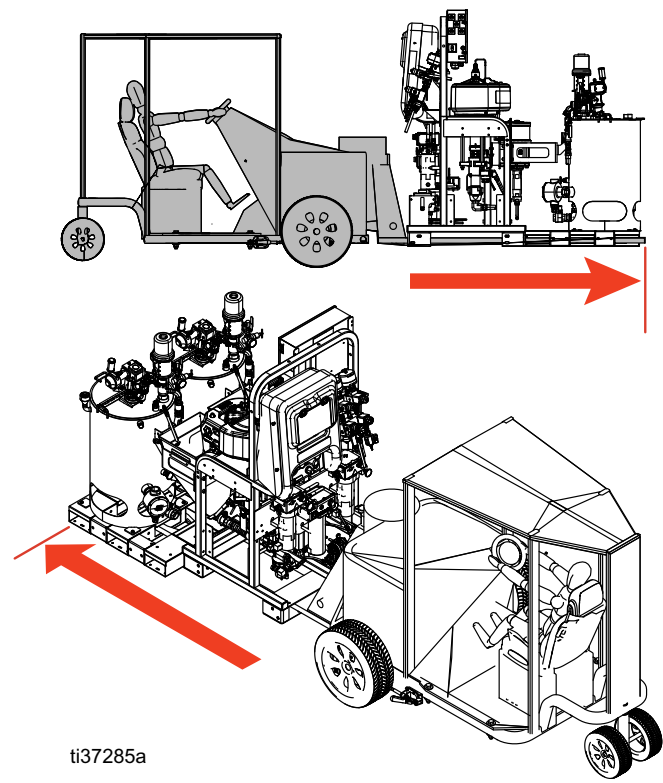

## Lift Using a Hoist

Sprayer can also be lifted and moved using a hoist. Connect a bridle swing, hooking an end to each of the air motor lift rings. Hook the center ring to a hoist. See the following figure. Carefully lift the sprayer; make sure it balances evenly. Do not lift with 25 gallon hoppers attached to the unit.

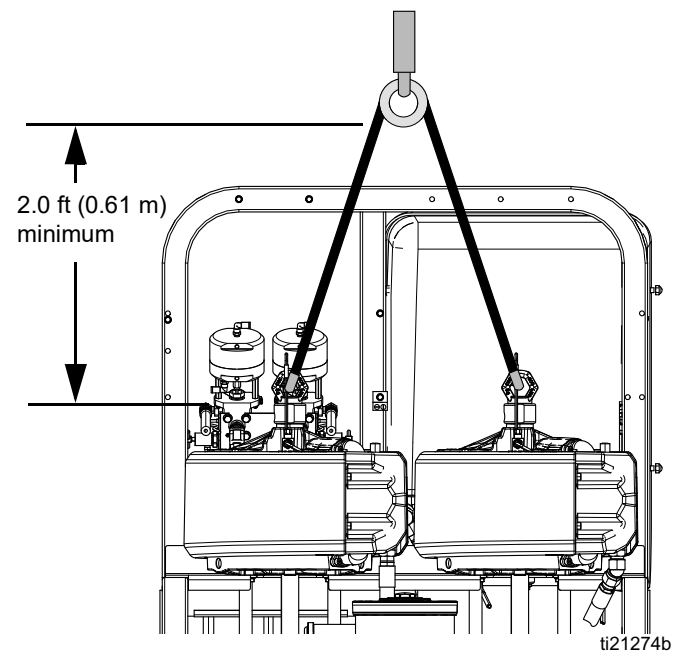

# Initial System Setup

Complete the following steps in order, as they apply to your specific system, for initial system setup.

1. Check your shipment for accuracy. Ensure you have received everything you ordered. See **Component Identification**, page 19, to familiarize yourself with typical system components.
2. Mount caster kit, if ordered. See your kit manual.
3. Replace USB label (front of control panel) with correct language version, if needed.
4. Replace Alarms Codes label (under fluid control valves) with correct language version, if needed.
5. Ground all equipment in the work area. See **Grounding** on page 28.
6. For non-hazardous location sprayers without primary fluid heaters and junction box, connect the supplied power cord. See **Connect Power Source**, page 28, for instructions.
7. For hazardous location sprayers, connect explosion-proof heaters. See **Connect Explosion-Proof Heaters**, page 31, and your heater manual.

8. Connect air supply line. See **Connect Air Supply**, page 31, for instructions and recommendations.
9. Connect fluid hose assembly, including whip hose and gun. See **Connect Fluid Hose Assembly**, page 32, for instructions. Also connect remote mix manifold, if ordered. See your Mix Manifold manual for installation and parts information (**Related Manuals**, page 3).
10. Add heating fluid to 25 gallon heated hoppers and service agitator and feed pumps for service, if applicable.

**NOTE:** A minimum of 12 gallons (45 liters) of ethylene glycol and 12 gallons of water is needed, plus additional water is needed if a water heated hose is used.

**NOTE:** A minimum of 10 gallons (39 liters) of “A” and “B” materials are needed to load the hoppers and prime the system.

**NOTE:** A minimum of 25 gallons (95 liters) of solvent is required for flushing.

**NOTE:** Empty metal pails for both “A” and “B” materials are required for flushing.

# Component Identification

## Typical Setup: 25 Gallon Double Wall Hopper with Recirculation

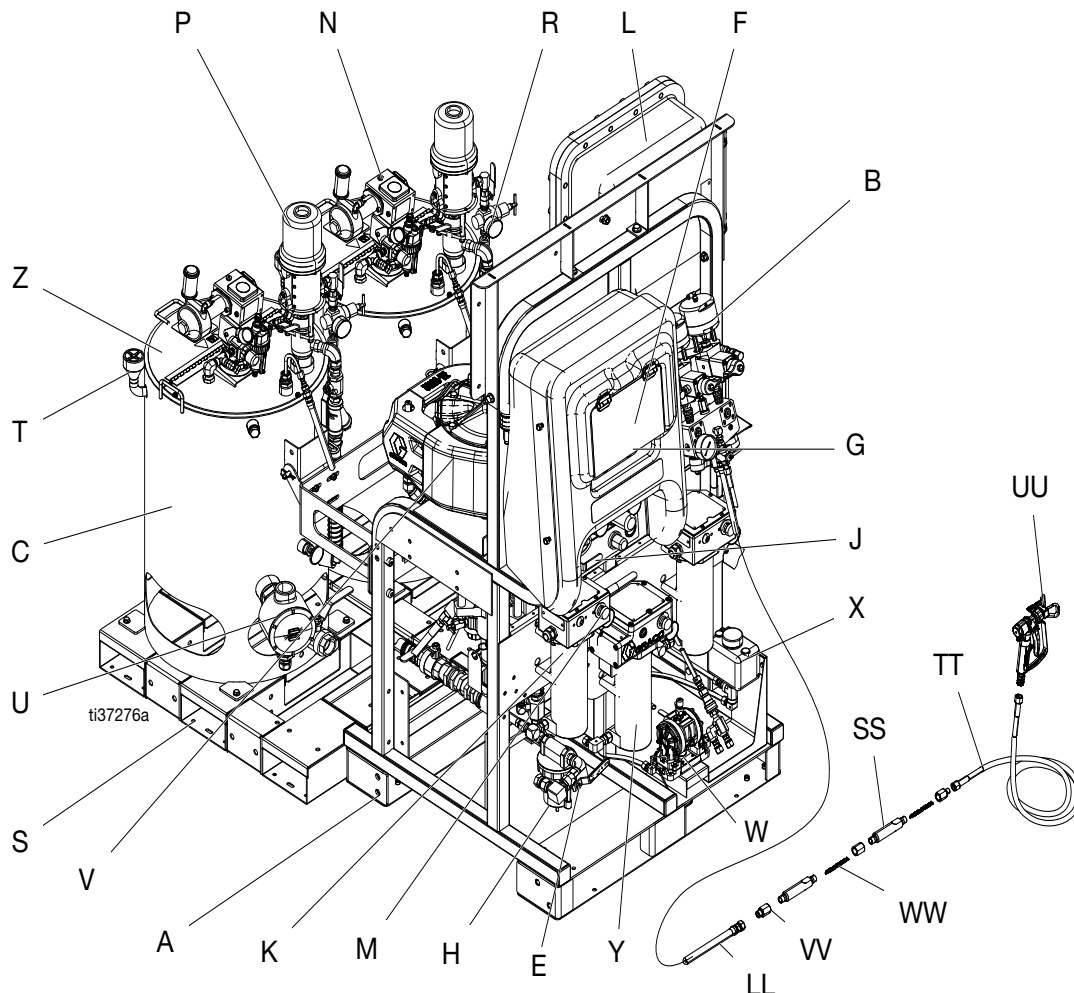
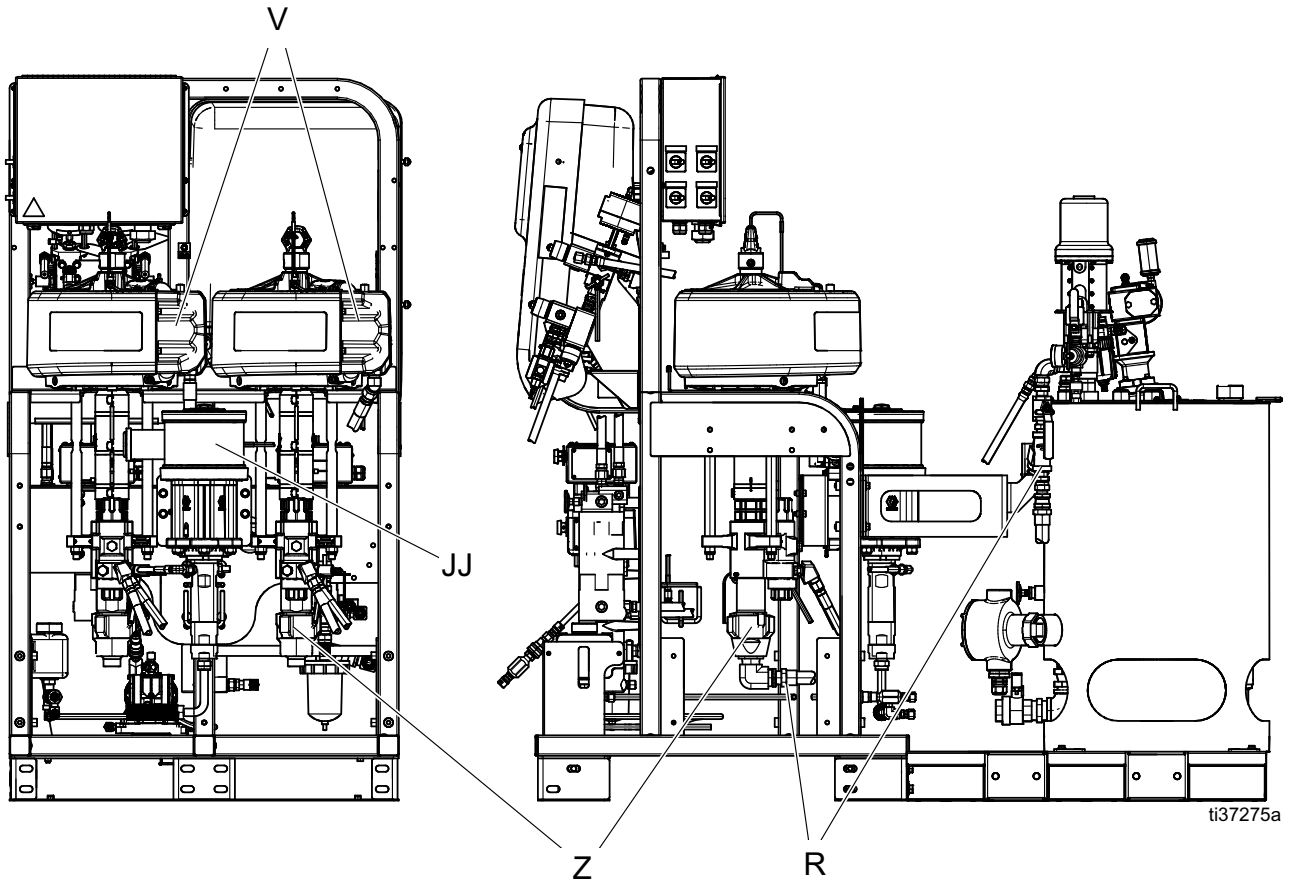

**FIG. 1: Typical Setup: 25 Gallon Double Wall Hopper with Recirculation (Front View)**

### Key:

A	Frame	R	Fluid Inlet Assembly
B	Fluid Control Assembly (see <b>Fluid Control Assembly</b> page 22).	S	Tank Pallet
C	25 Gallon Double Wall Hopper	T	Fill Port Cap
E	Main Air Valve	U	Immersion Heater
F	GCA Control Display (see <b>User Interface</b> , page 25)	V	Air Motor
G	Pump Control On and Off Buttons	W	Diaphragm Pump Assembly (Water Heated Hose only)
H	Air Filter	X	Overflow Tank (Water Heated Hose only)
J	Air Controls	Y	Viscon HP Fluid Heater (Water Heated Hose only)
K	Viscon HF Fluid Heater	LL	Integrator Hose
L	Junction Box/Heater Controls (see <b>Junction Box</b> , page 23)	SS	Static Mixer Housing
M	Viscon HF Fluid Heater Control	TT	Fluid Whip Hose
N	Air Powered Agitator	UU	Airless Spray Gun
P	Pressure Feed Pump	VV	Static Mixer Adapter
		WW	Static Mixing Element

## Typical Setup: 25 Gallon Double Wall Hopper with Recirculation (Back and Side Views)



**FIG. 2: Typical Setup: 25 Gallon Double Wall Hopper with Recirculation (Back and Side Views)**

**Key:**

- R Fluid Inlet Assembly
- V Air Motor
- Z High Pressure Fluid Pump
- JJ Solvent Flush Pump (Mercur<sup>®</sup> Pump)

## Heater Information

Viscon HF Fluid Heaters (K): Primary heaters that heat the resin and hardener before mixing. Improves the chemical reaction and lowers viscosity to improve the spray pattern. There are two Viscon HF heater variants (hazardous location heaters and non-hazardous location heaters). For approval rating, see **Models** on page 9 and **Approvals** on page 11 regarding your primary fluid heaters.

Viscon HP Fluid Heaters (Y): These are used for heating water or oil through heated hose to prevent material from losing heat when spraying remote. They are used with a diaphragm pump to circulate the heated fluid throughout the hose. There are two Viscon HP heater variants (hazardous location heaters and non-hazardous location heaters). For approval ratings, see **Models** on page 9 and **Approvals** on page 11 regarding your water heated hose fluid heaters.

Hopper Heaters (U): Immersion heaters are used to heat the outer jacketed area of the double walled hoppers. The outer jacket is filled with oil or a 50% water and 50% ethylene glycol mixture to heat the spray material. The double wall hopper design prevents the spray material from losing heat.

## Pump Information

High Pressure Fluid Pumps (Z): These pumps feed the A and B fluid.

Solvent Flush Pump (JJ): This pump flushes the mix manifold, hose, and gun.

Pressure Feed Pump (P): This pump transfers material from the 25 gallon heated hoppers to the main high pressure pumps. This is the preferred method of transferring viscous material compared to gravity feed.

Diaphragm Pump (W): This pump is used to circulate the heated water through water heated hose.

## Fluid Control Assembly

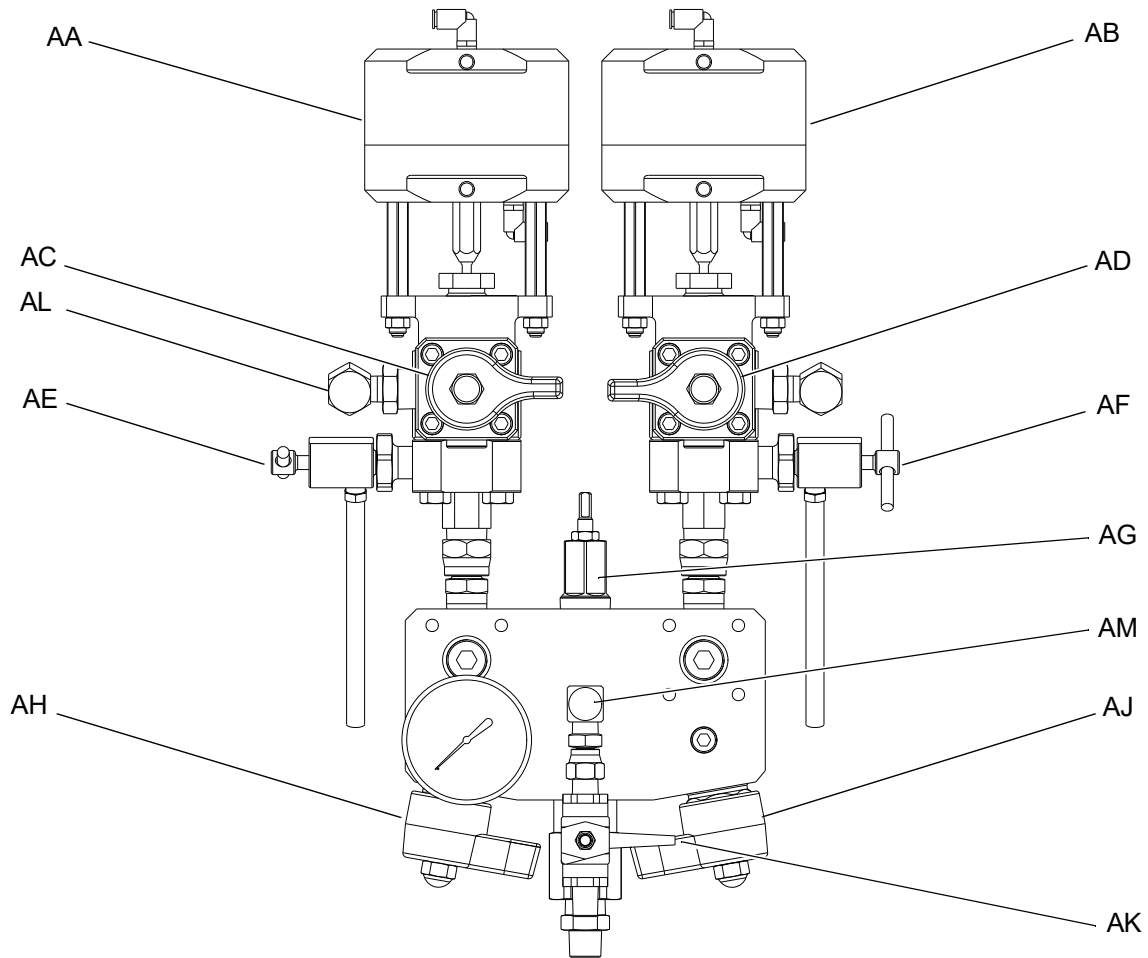

**FIG. 3: Fluid Control Assembly**

- |                          |   |
|--------------------------|---|
| AA Dosing Valve A        | AF Sampling Valve B                     |
| AB Dosing Valve B        | AG Restriction Valve                    |
| AC Recirculation Valve A | AH Mix Manifold Shutoff / Check Valve A |
| AD Recirculation Valve B | AJ Mix Manifold Shutoff / Check Valve B |
| AE Sampling Valve A      | AK Solvent Shutoff Valve                |
|                          | AL Pressure Sensor                      |
|                          | AM Solvent Check Valve                  |

# Junction Box

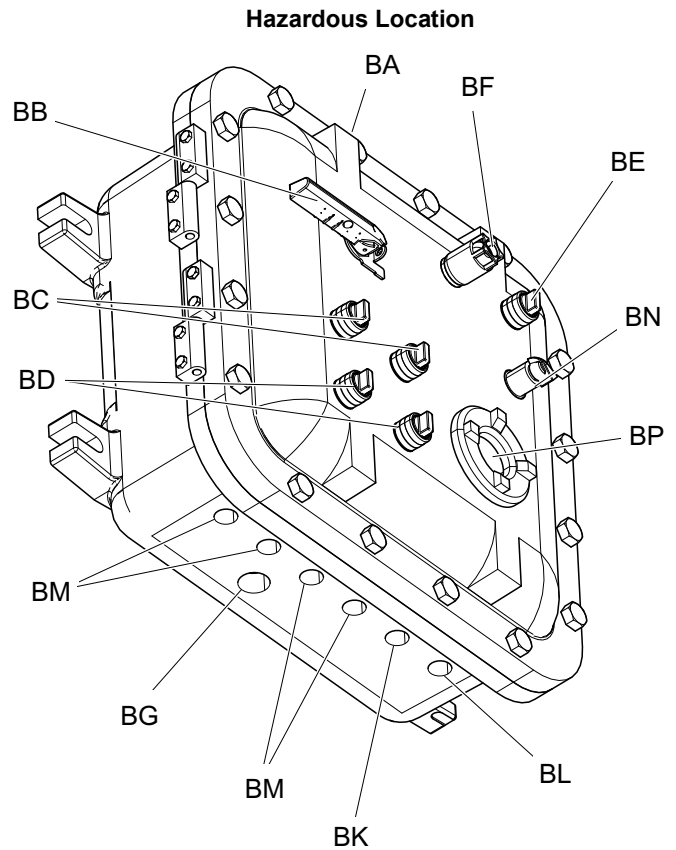
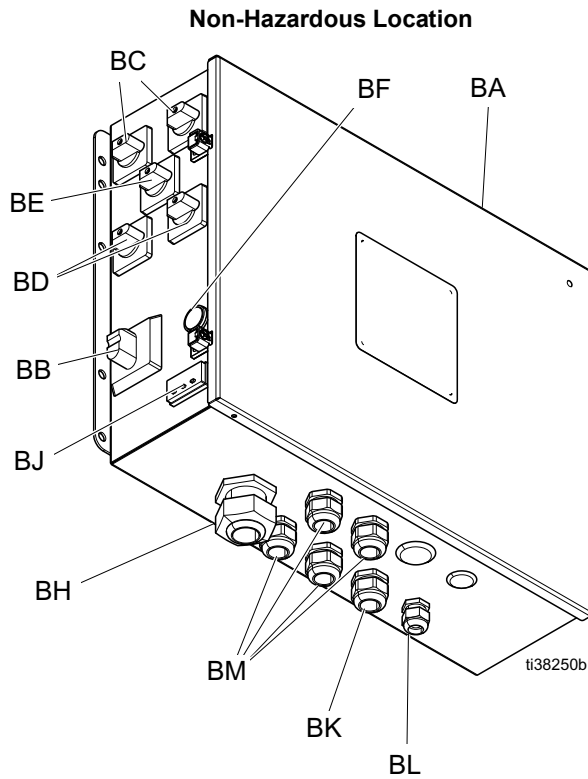

**Key:**

- BA Electrical Enclosure
- BB Main Power Switch
- BC Primary Heater Switches
- BD Hopper Heater Switches
- BE Hose Heater Switch
- BF Power Indicator Light
- BG Main Power Entry Point
- BH Strain Relief (Non-hazardous locations only)

- BJ Electric Heated Hose Temperature Controller / Display (Non-hazardous locations only)
- BK Hose Heater Harness Entry Point
- BL Thermocouple Sensor Entry Point
- BM Fluid Heater and Hopper Heater Harness Entry Point
- BN Electric Heated Hose Temperature Controller (Hazardous locations only)
- BP Temperature Display (Hazardous locations only)

## Air Controls

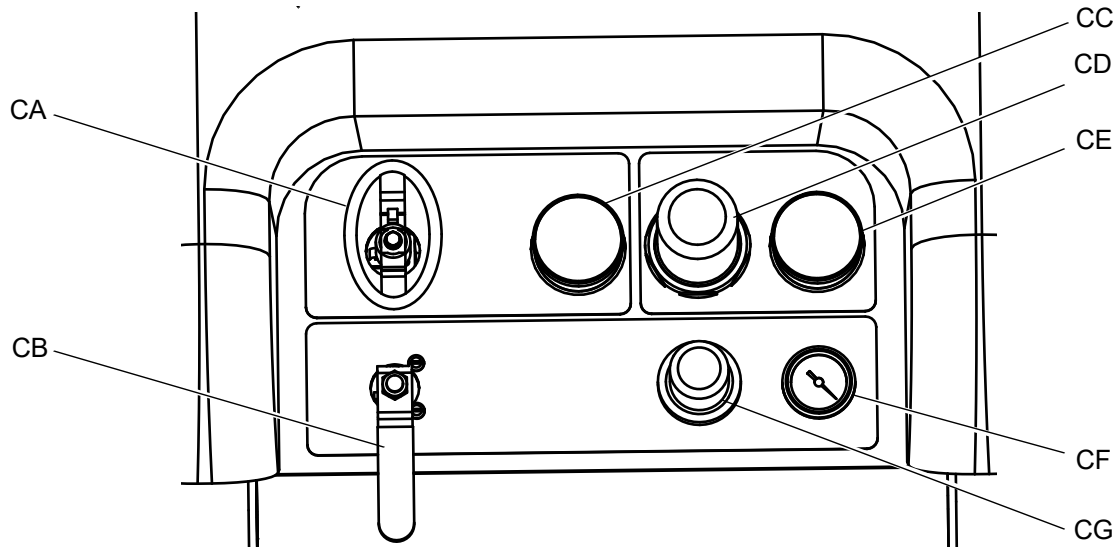

**FIG. 4: Air Controls**

CA Main Pump and Air On/Off Control  
CB Solvent Pump Air On/Off Control  
CC Inlet Air Pressure Gauge  
CD Main Pump Air Regulator

CE Main Pump Air Regulator Pressure Gauge  
CF Solvent Pump Air Pressure Gauge  
CG Solvent Pump Air Regulator



# User Interface

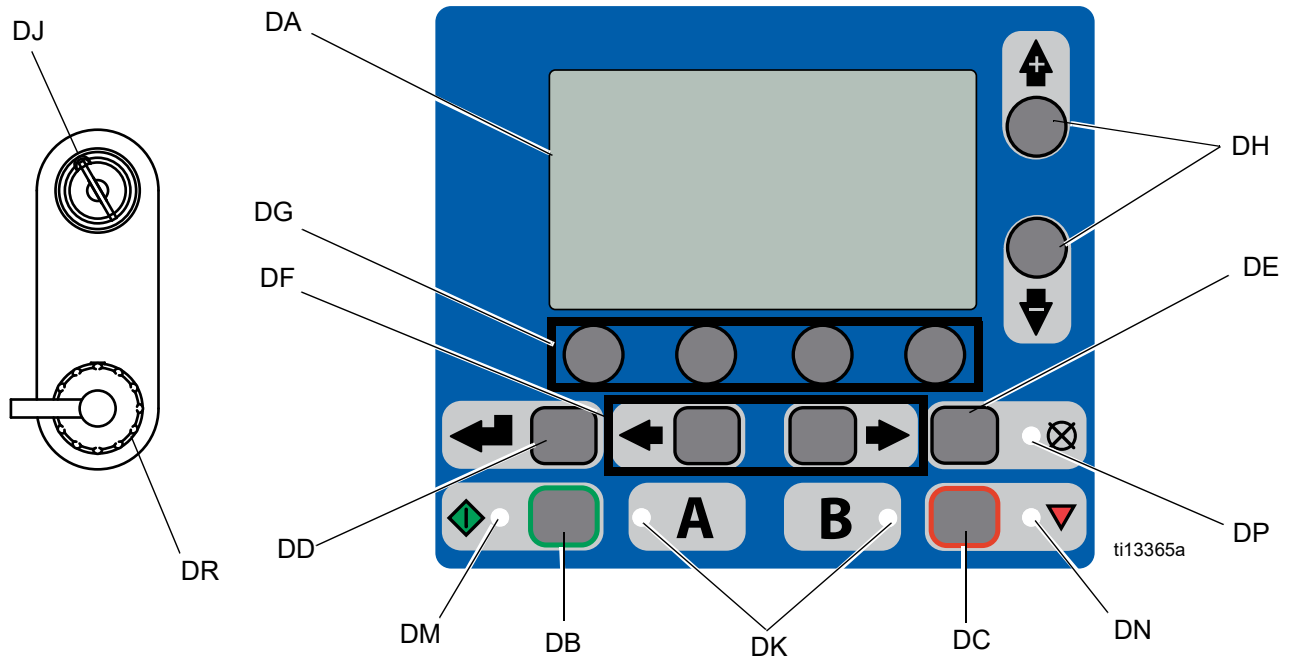

FIG. 5: User Interface

## Buttons

Ref.	Button	Function
DA	Display Screen	Use to view Ratio, Mode Selection, Error Conditions, Totalizers, System Information.
DB	Start	Initiates Active Run Mode function currently selected in Run Screen.
DC	Stop	Terminates Active Run Mode function currently selected.
DD	Enter	Press to open drop-down fields, selection options, and save values.
DE	Alarm Reset	Resets alarms and advisories.
DF	Left/Right	Move between screens in run or setup modes.
DG	Function	Activates mode or action represented by the icon above each of the four buttons in the LCD.
DH	Up/Down	Move between selection boxes, drop-down fields, and selectable values within Setup screens.
DJ	Setup Key Lock	Change ratio or enter Setup mode.
DR	USB Port	Connection for data download. Use only in non-hazardous locations.

## LEDs

There are four types of LEDs on the display.

Ref.	LED	Function
DK	Blue	Dosing valve active - on - dosing valve is active - off - dosing valve is not active
DM	Green	Spray mode active - spray mode is on (active) - spray mode is off (inactive)
DN	Red	Alarm - on - alarm is present - off - no alarm
DP	Yellow	Warning - on - is active. - off - no warning indicated. Ratio and setup fields are not changeable. - flashing - key is present and turned. Ratio and setup fields are changeable.

## Hopper Assembly

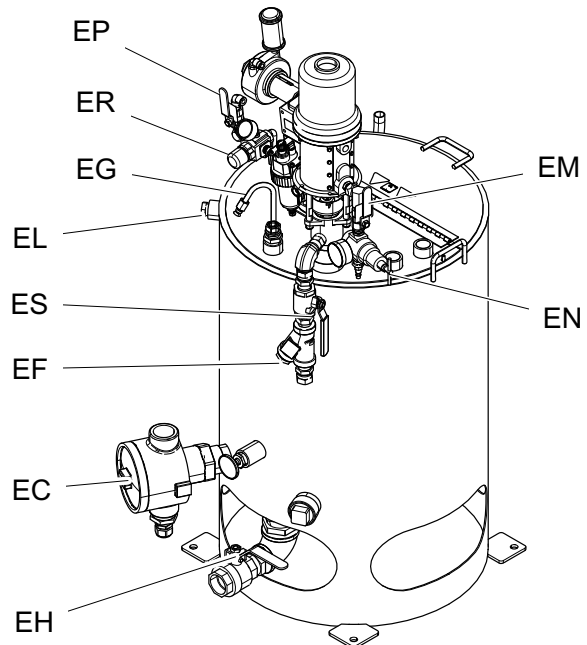
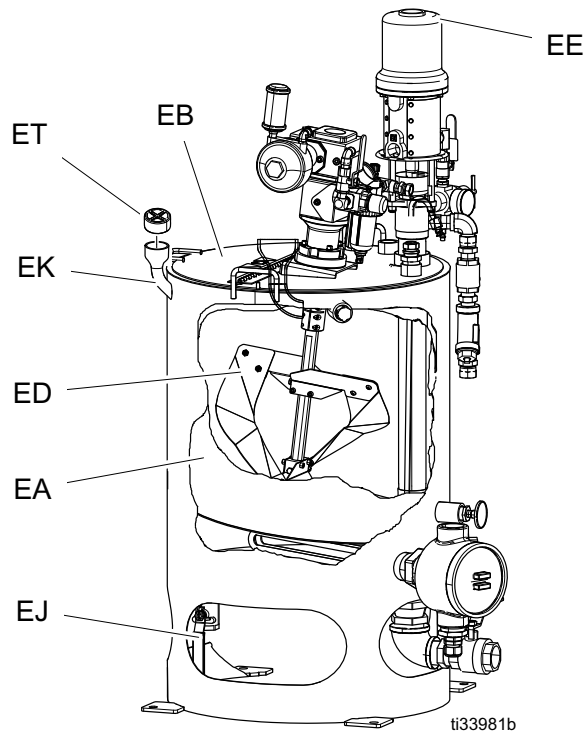



**Key:**

- EA Double-Wall Hopper
- EB Hopper Lid
- EC Immersion Heater
- ED Agitator
- EE Feed Pump
- EF Y-Strainer
- EG Recirculation Tube
- EH Material Drain
- EJ Heating Fluid Drain Valve
- EK Heating Fluid Fill Port
- EL Heating Fluid Vent
- EM Air Valve (Feed Pump)
- EN Air Regulator (Feed Pump)
- EP Air Valve (Agitator)
- ER Air Regulator (Agitator)
- ES Y-Strainer Valve
- ET Fill Port Cap

## User Interface Display

For details regarding the user interface display see **User Interface Display**, page 76.

### Main Display Screen Components

The system ratio mode shows if the mix ratio target is by volume  or weight . If the weight is crossed out, the system must be calibrated before running. Follow **Pump and Metering Test**, page 52.

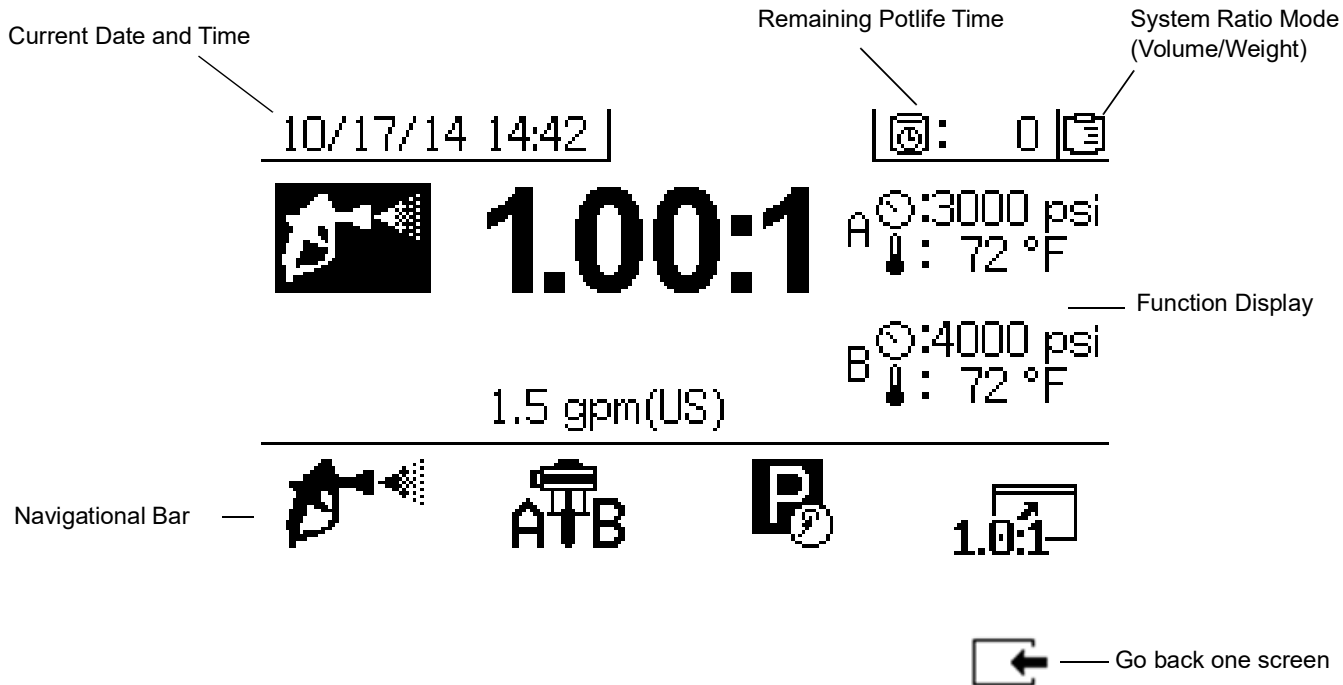

**FIG. 6: Main Display Screen Components (shown with all display features enabled)**

**NOTICE**

To prevent damage to soft key buttons, do not press the buttons with sharp objects such as pens, plastic cards, or fingernails.

# Setup

## Grounding



The equipment must be grounded to reduce the risk of static sparking and electric shock. Electric or static sparking can cause fumes to ignite or explode. Improper grounding can cause electric shock. Grounding provides an escape for the electric current.

**System:** Connect the power source ground wire in the electrical compartment as show in **Connect Power Source** on page 28. Connect the XM sprayer ground wire clamp (FG) to a true earth ground.

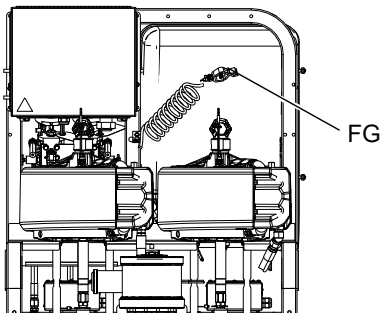

**Air and fluid hoses:** Use only electrically conductive hoses with a maximum of 500 ft (152 m) combined hose length to ensure grounding continuity. Check electrical resistance of hose regularly. If total resistance to ground exceeds 29 megaohms, replace hose immediately.

**Spray gun:** Ground through connection to a properly grounded fluid hose and pump.

**Solvent pails:** Follow your local code. Use only conductive metal pails, placed on a grounded surface. Do not place the pail on a non-conductive surface, such as paper or cardboard, which interrupts grounding continuity.

**To maintain grounding continuity when flushing or relieving pressure:** hold the metal part of the spray gun firmly to the side of a grounded metal pail, then trigger the gun.

**Object being sprayed:** Follow your local code.

**Fluid supply container:** Follow your local code.

**Air compressor:** Follow manufacturer's recommendations.

## Connect Power Source



To help prevent injury from electric shock, turn off and disconnect power at the main switch before connecting any cables and before servicing equipment. All electrical work must be done by a qualified electrician and comply with local codes and regulations.

See **Power Cord Guidelines** on page 96 for information specific to XM models.

### XM \_ L \_ \_ Models

For sprayers that are wall powered and less than 240 V in non-hazardous locations only.

Sprayers must be used in non-hazardous locations and with a U.S. style NEMA 5-15 plug. Power cord adapters are supplied with European and Australian cord sets.

## XM \_ M \_\_, XM \_ H \_\_, XM \_ J \_\_, and XM \_ K \_\_ Models

For sprayers with junction boxes to include 230V-480V.

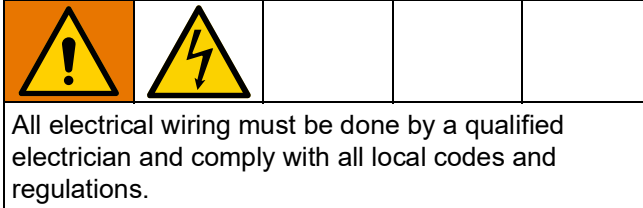

Use the intended entry locations shown in **Junction Box**, page 23.

1. Turn the main power switch (BB) Off.
2. Open the junction box door.
3. **Non-Hazardous Locations only:** Route the power cord through the strain relief (BH) into the electrical enclosure (BA).

**Hazardous Locations only:** Follow local codes and regulations for routing the power cord through the main power entry point (BG) electrical enclosure (BA).

4. Connect the ground wire to ground terminal (GT). See FIG. 7, page 30.
5. Connect the power cord to the disconnect as shown in the FIG. 7, page 30. Tighten conductors to 55 in-lb (6.2 N•m). Gently pull on all connections to verify that they are properly secured.
6. **Non-Hazardous Locations only:** Tighten strain relief (BH).  
**Hazardous Locations only:** Follow local codes and regulations for sealing the power cable entering into the enclosure.
7. Install the supplied terminal jumpers in the positions shown in the FIG. 7, page 30.
8. Verify that all items are connected properly as shown in the FIG. 7, page 30, then close the junction box door.

**NOTE:** The machine is provided with jumpers in the 380 Vac 3-Phase Wye position.

**NOTE:** Jumpers are only applicable with 230V-380V.

# Wiring Diagram

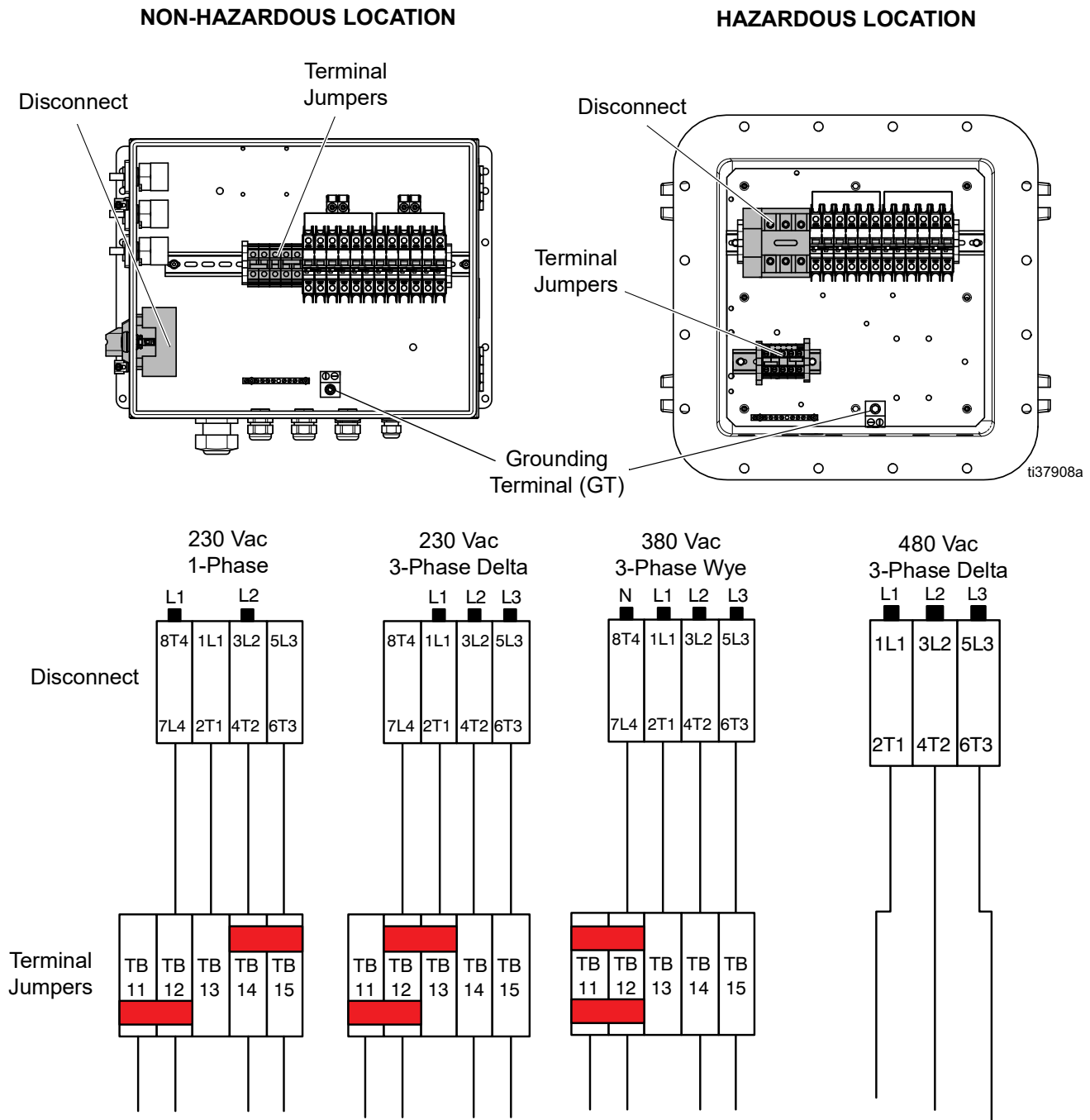





FIG. 7: XM Wiring Diagram

## Connect Explosion-Proof Heaters

### Hazardous location sprayers only (XM\_J\_\_ and XM\_K\_\_)

				
<p>If your sprayer is intended for hazardous locations, a qualified electrician must connect the explosion-proof heater wiring. Ensure wiring and installation comply with local electrical codes and regulations for hazardous locations.</p> <p>Improperly installed or connected equipment may result in fire, explosion, or electric shock. Follow local codes and regulations.</p>				

Ensure wiring, wiring connections, switches, and electrical distribution panel all meet flame-proof (explosion-proof) installation requirements.

Refer to your Junction Box manual for the wiring diagram for hazardous locations.

Refer to your Viscon HP heater manual for electrical connection instructions and guidelines in hazardous locations.

Refer to your Viscon HF heater manual for electrical connection instructions and guidelines in hazardous locations.

## Connect Air Supply

Connect air supply line (SL) to 1.0 in. (10.1 mm) npt(f) air filter inlet.

Use a 1.0 in. (25.4 mm) ID minimum air hose.

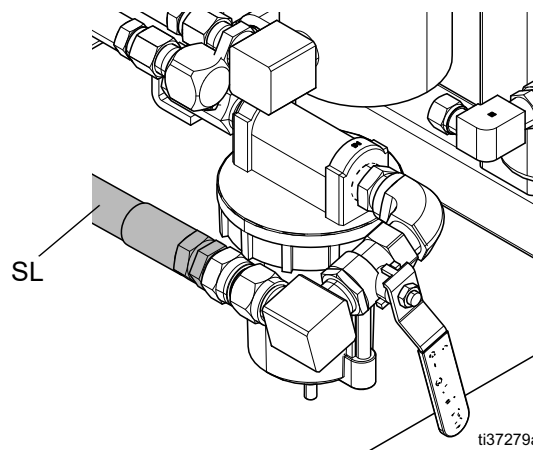

**Air supply requirement:** 150 psi (1.0 MPa, 10.3 bar) maximum; 50 psi (0.35 MPa, 3.5 bar) minimum while running **System Verification** (page 52), and 80 psi (0.55 MPa, 5.5 bar) while spraying.

**Flow volume required:** 70 scfm (1.96 m<sup>3</sup>/min) minimum; 250 scfm (7.0 m<sup>3</sup>/min) maximum. Available fluid pressure and flow rate are directly related to available air volume. See **Pump Performance Charts**, page 103.

#### General flow volume guidelines:

- 70 scfm (1.96 m<sup>3</sup>/min) per gpm (lpm) while spraying
- 10 scfm (0.28 m<sup>3</sup>/min) added per agitator
- 10 scfm (0.28 m<sup>3</sup>/min) added per drum feed pump

If your sprayer is for use in hazardous locations, the control display (F) is powered by an air-driven alternator.

Dosing valves are operated by air. The dosing valves on the sprayer will not operate correctly if the inlet air gauge drops below 80 psi (0.55 MPa, 5.5 bar) while spraying. The B side dosing valves may not be able to close, which will result in B overdosing and going off ratio.

## Connect Fluid Hose Assembly

1. Connect fluid hose to fluid manifold outlet. Do not install gun spray tip yet.

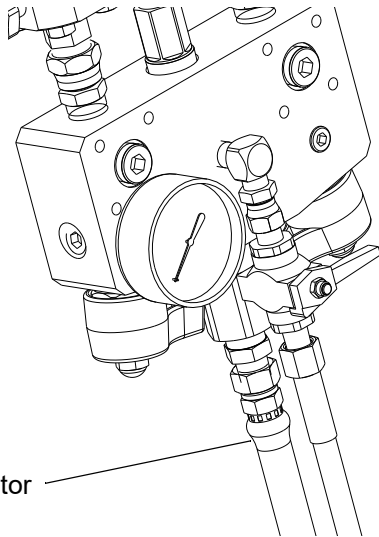

### NOTICE

Do not assemble static mixer directly to the fluid manifold. Install static mixer after first 25 ft (7.5 m) of integrator hose to ensure material doses are completely integrated. Spraying poorly integrated material could require rework of parts sprayed.

2. Tighten all fittings.

**NOTE:** If using electric heated hose, see your electric heated hose manual for installation and operation instructions.

**NOTE:** If using a water heated hose, see your hopper and hose heat circulation manual for installation and operation instructions.

**NOTE:** If a recirculation remote mix manifold kit (273185) is used, see your Remote Recirculation Manifold for Installation and Parts and XM Mix Manifold Kits manual for operation instructions on priming and flushing. (**Related Manuals**, page 3).

**NOTE:** If using remote mix manifold, see your XM Mix Manifold Kits manual for operation instructions. (**Related Manuals**, page 3).

## Adjust Packing Nuts

1. Fill A and B pump packing nuts with throat seal liquid (TSL™) and torque to 50 ft-lb (67.5 N•m). For more detail regarding your Xtreme Lower pump, see your Xtreme Lowers manual.

**NOTE:** Re-torque the packing nuts after the first day of use.

2. Fill dosing valves A and B packing nuts with throat seal liquid (TSL) and tighten 1/4 turn after nut contacts packings; about 145-155 in-lb (16-18 N•m).

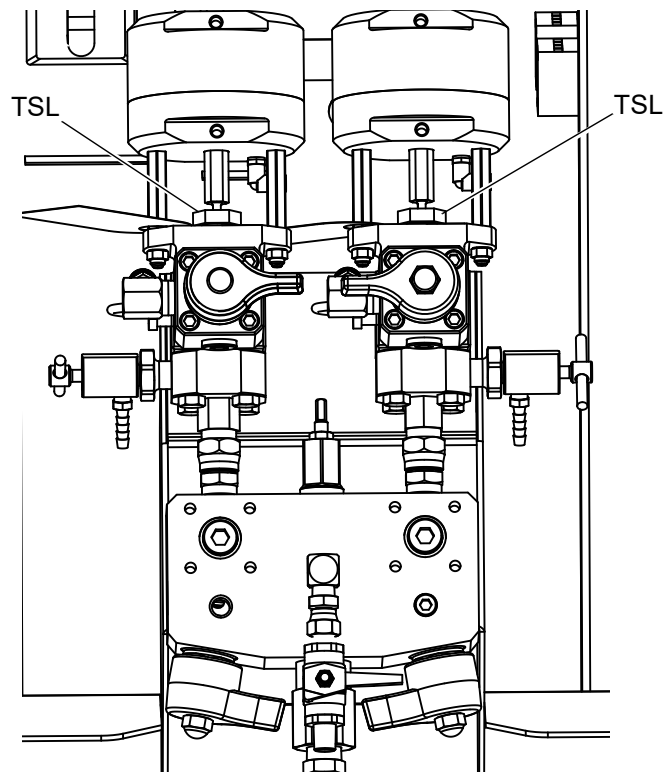

For pump and dosing valves, check packing nut tightness after first hour of operation and again after 24 hours. Then check when TSL discolors or seeps over packing nut. Also check tightness whenever sprayer is transported. Tighten packing nuts only when all fluid pressure is relieved. Continue to follow maintenance procedure intervals regarding all seals, page 64.



# Basic Operation

## Power On

### (Alternator Power Supplied Systems for Hazardous Location Sprayers)

NOTE: The hazardous location XM model variants feature an intrinsically safe alternator powered by a compressed air-fed turbine as a power supply. Ensure your intrinsically safe alternator module is set to working pressure 18 +/- psi (12.6 +/- 10 kPa, 1.26 +/- 0.07 bar). Refer to your XM Proportioner Repair-Parts manual for additional instructions.

1. Set main pump air regulator (CD) to minimum setting.
2. Open main air valve (E) and main pump and air valve (CA) to start air-powered alternator.

Main air pressure is displayed on gauge (CC). Fluid Control screen will display after five seconds. See **Run (Fluid Control) Screens**, page 86.

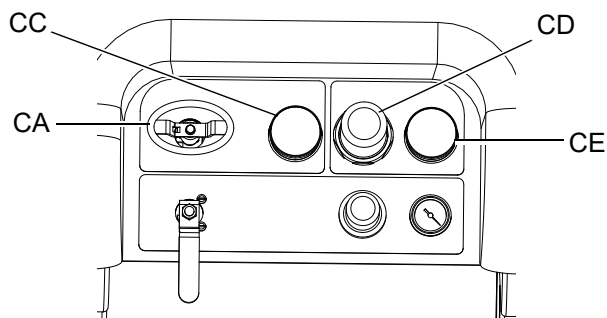



## Power On

### (Wall Power Supplied Systems)

Turn on main power (BB). Fluid Control screen will display after five seconds. See **Run (Fluid Control) Screens**, page 86.

## Adjust Ratio and Setup

1. Turn key (DJ) to right (setup position). Yellow LED will flash and the Home Setup screen will display.

2. Press  and  to change ratio.
3. When desired ratio is displayed, turn key to left. Yellow LED will turn off.
4. Change optional setup selections to desired parameters, as described in **Set System Settings (Optional)**, page 34.

## View Alarms

When an alarm occurs the alarm information screen automatically displays. It shows the current alarm code along with a bell icon. It also shows the alarm location with top and side views of the sprayer.

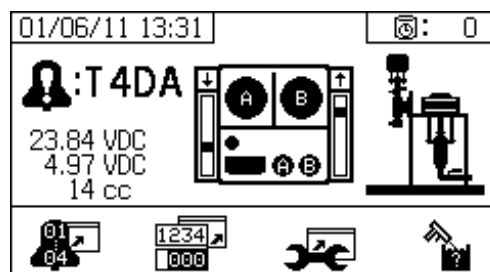



There are two levels of error codes: alarms and advisories. A bell icon indicates an alarm. A solid bell icon with an exclamation point and three audible alerts indicate a alarm. And an outlined hollow bell icon and a single audible alert indicate an advisory.

### Diagnose Alarms

See **Alarm Codes and Troubleshooting**, page 65, for causes and solutions to each alarm code.

### Clear Alarms

Press  to clear alarms and advisories. Press  to return the run (fluid control) screen.

For more information on alarms and alarm codes, see **LED Diagnostic Information**, page 63.

## Set System Settings (Optional)

For details regarding the user interface display screens see **User Interface Display**, page 76.

To set user interface parameters and USB parameters,

press  from the Home Setup screen.





### Set User Interface Parameters

Press  from the potlife/hose length screen to move to the user interface parameters screen.

The following user interface parameters are configurable:



- date format
- date (factory set)
- time (factory set)
- units of measurement for:
  - fluid flow rate
  - pressure
  - temperature
  - hose length
  - weight



To change the date format, press  to select the field.

Press  to open the drop down field. Press  and  to select the preferred format. Press  again to save that date format. Follow this procedure to change the units of measurement formats as well.

To change the date and time, press  to select the

field. Press  to make the field selectable. Press

 and  to scroll through each digit. Press

 and  to move to the next digit in the field.

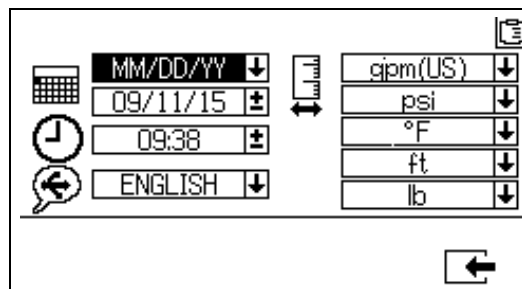

Press  to save the change.







### Set USB Parameters

Press  from the user interface parameters screen to move to the USB parameters screen.

To set the sprayer number, configure the number of hours downloaded to external USB flash drive, and how

often the data will record: press  and  to move through each field. Press  to make a field

selectable. Press  and  to scroll through each digit. Press  and  to move to the next digit in each field. Press  to save the change.

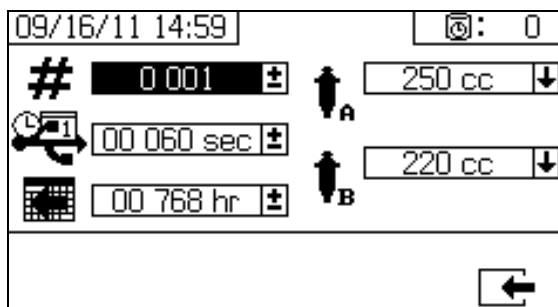

## Set Maintenance Parameters (Optional)

Prior to configuring system settings, follow **Enable Setup Screens**, page 82, to ensure screens shown in this section are viewable and configurable. If they are not, follow instructions in **Enable Setup Screens** to enable them.







For details regarding the user interface display screens see **User Interface Display**, page 76.

To set maintenance parameters for pumps and valves,

including maintenance schedules, press  from the Home Setup screen.





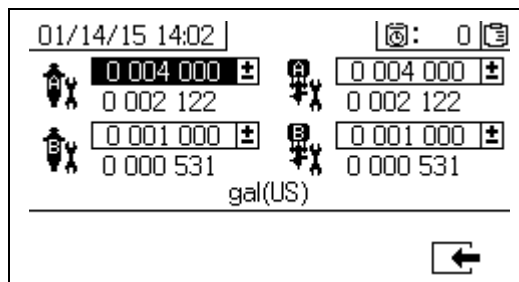

Use the first screen to set maintenance setpoint amounts for pumps and dosing valves. Use the second screen to set the maintenance schedule for changing the incoming air filter.

### Set Maintenance Setpoints

To set maintenance setpoint values, press  and  to move through each field, and press  to make a field selectable. Press  to scroll through each setpoint digit. Press  and  to scroll through the optional values. Continue this process until the desired setpoint is reached. Press  to save that setpoint.



### Set Maintenance Schedule

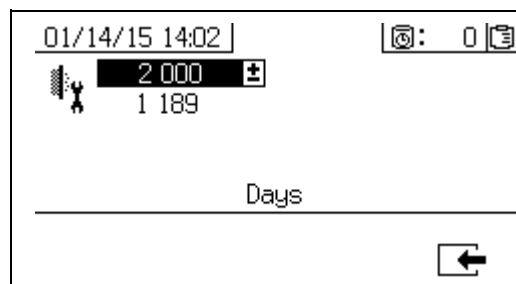

To set the number of days between changing the incoming air filter that will result in a reminder advisory, press  to move to the Maintenance Setup 2 screen. Press  to make the field selectable. Press  to scroll through each digit, and press  and  to scroll through the optional values. Press  to save the number of days value.



## Set Sprayer Limits (Optional)







For details regarding the limits setup screens, see **User Limits Setup Screens**, page 84.

To set and adjust pump pressure limits and temperature limits:

1. Select  in the Enable Setup 2 screen. Follow **Enable Setup Screens**, page 82, for instructions.
2. From the Home Setup screen press  to jump to the limits screens.
3. Follow the instructions in **Set Pressure Limits** and **Set Temperature Limits**.

### Set Pressure Limits

Use the following instructions to set pressure limits for each pump that if met will issue an advisory and/or warning.

To set pressure limits, press  and  to move through each field, and press  to make a field selectable. Press  to scroll through each pressure digit, and press  and  to scroll through the optional values. Continue this process until you reach the desired pressure limit. Press  to save.



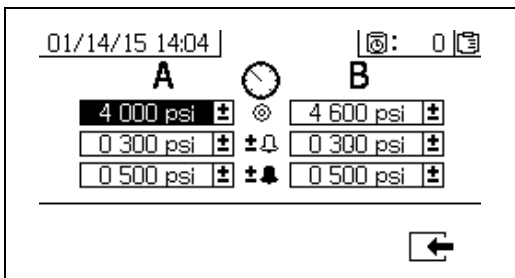



The B pump pressure always runs 10-20% higher than the A pump pressure.



### Set Temperature Limits

Use the following instructions to set temperature limits that if met will issue an advisory and/or warning.

Press  to move to the temperature limits screen.

To set temperature limits, press  and  to move through each field, and press  to make a field selectable. Press  to scroll through each temperature digit, and press  and  to scroll through the optional values. Continue this process until you reach your desired temperature limit. Press  to save the value.

The allowable range for the temperature setpoint is 34° - 160° F (1° - 71° C).

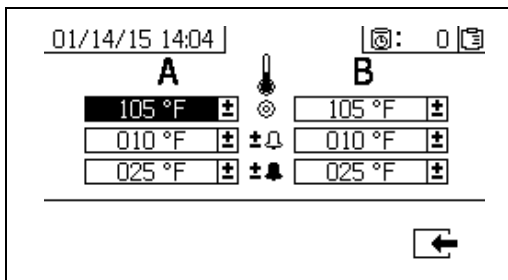

# Prime

## Prime A and B Fluids

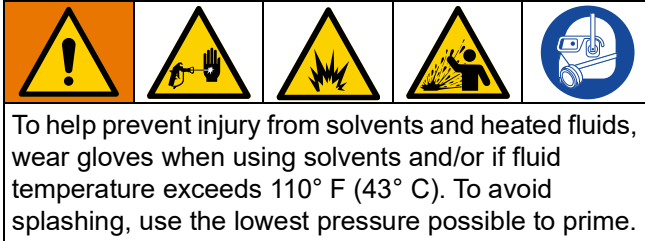

**NOTE:** Do not install gun spray tip yet.

1. Condition materials prior to adding to hoppers. Ensure resin materials are thoroughly agitated, homogenous, and pourable prior to adding to hopper. Stir hardeners back into suspension prior to adding material to hopper.
2. Fill A and B hoppers with proper materials. Fill A side with major volume of material; fill B side with minor volume of material.

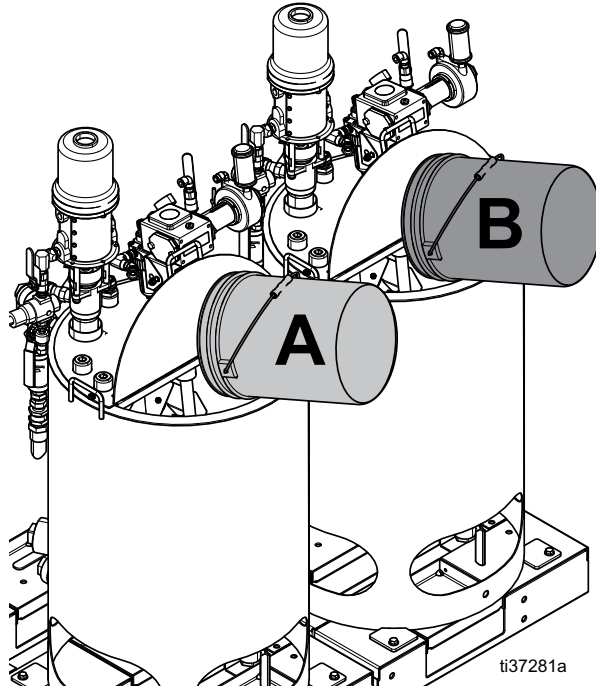

**25-Gallon Stainless Steel Hopper Shown**

3. Move recirculation lines to empty containers.

4. Open ball valves into pumps, or turn the feed pump air valve to the open position and open the air regulator to start the feed pump.

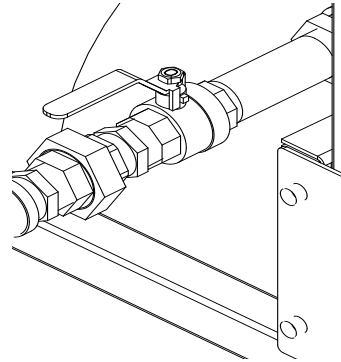

5. Turn mix manifold valves (AH, AJ) clockwise to close them.

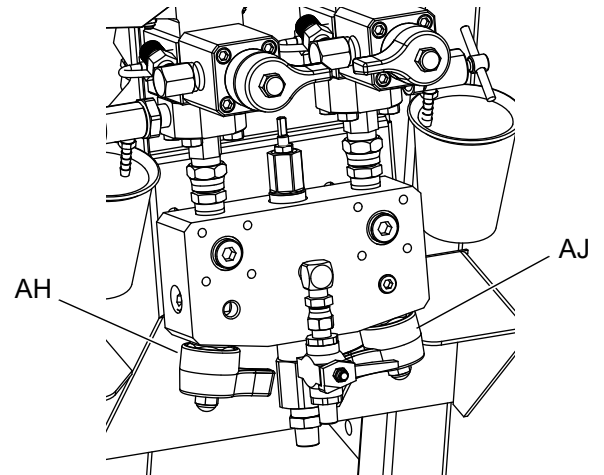

6. Open recirculation valves (AC, AD).

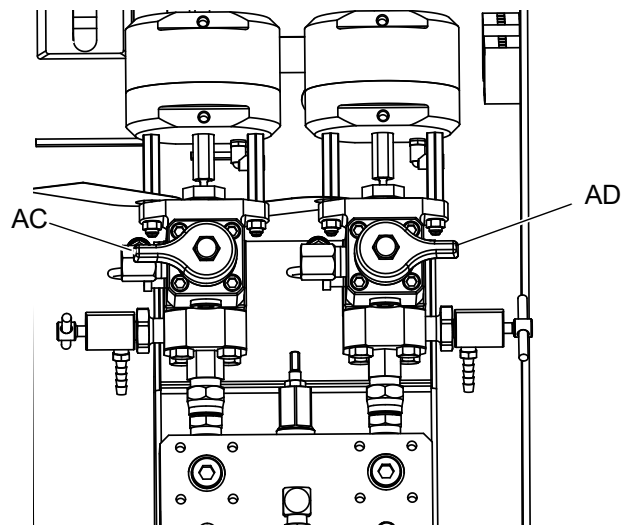



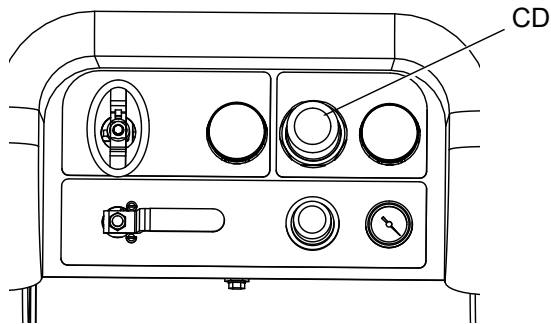

Prime



- Turn on air supply. Set main pump air regulator (CD) to 20 psi (138 kPa 1.38 bar).





- Use manual pump run mode.

**NOTE:** When run independently set to  or .

Press  and  as needed to prime. Monitor containers to avoid overflow.

- Select Pump A . Press . Slowly turn main pump air regulator (CD) clockwise to increase air pressure until pump A starts. Dispense into pail until clean fluid comes out of A. Close recirculation valve.

When priming or flushing pumps, it is normal to get cavitation or pump runaway alarms. Clear alarms .

and press  again as necessary. These alarms prevent excessive pump speeds, which will damage pump packings.

- Move recirculation line back to hopper.
- Repeat for B side.
- Dispense a small amount of each material through both sampling valves (AE, AF).

**NOTE:** Open sampling valves slowly to avoid splashing.

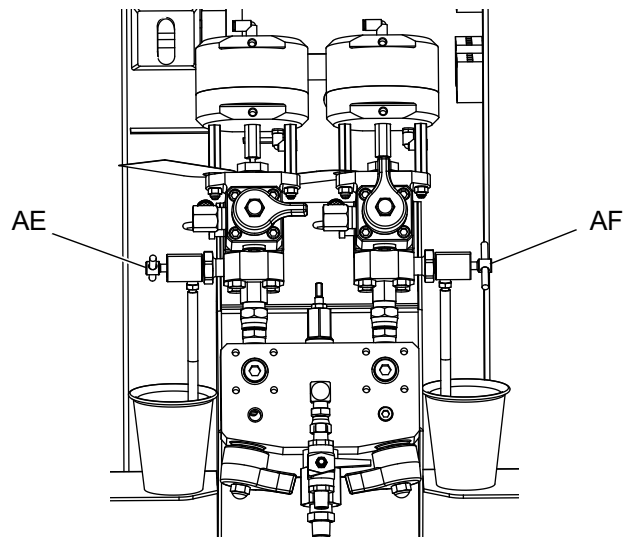

- Close both sampling valves (AE, AF).

**NOTE:** If a remote mix manifold is used, disconnect A and B hoses at remote mix manifold. Prime the A and B fluid lines with material. Reconnect hoses to remote manifold.

**NOTE:** If a recirculation remote mix manifold kit (273185) is used, see XM Mix Manifold Kits manual, (**Related Manuals**, page 3).

# Prime Solvent Flush Pump



1. Connect ground wire to a metal pail of solvent.
2. Place siphon tube in the pail of solvent.

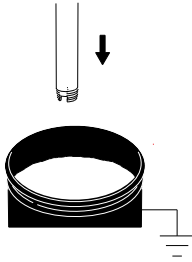

3. Open solvent flush valve (AK) on mix manifold.

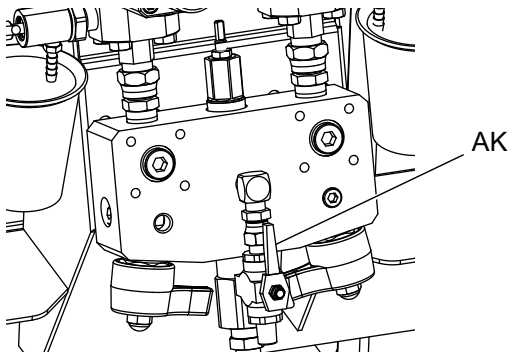

4. Ensure trigger lock is engaged. Remove spray tip.

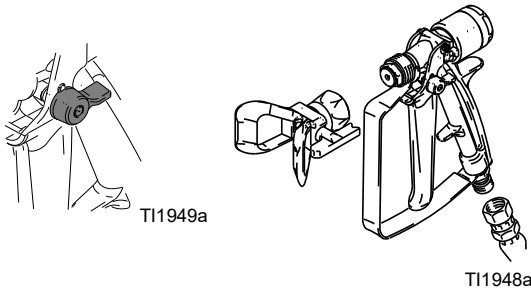

5. Disengage trigger lock and trigger gun into a grounded pail. Use a pail lid with a hole to dispense through. Seal around hole and gun with a rag to prevent splash back. Be careful to keep fingers away from front of gun.

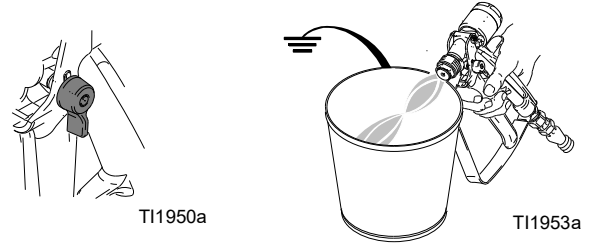

6. Open solvent pump air valve (CB). Pull out and slowly turn solvent pump air regulator (CG) clockwise to prime solvent pump and push air out of mix hose and gun. Trigger gun until all air is purged.

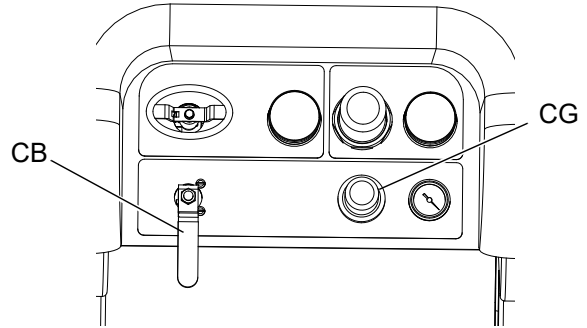

7. Close solvent pump air valve (CB) and trigger gun to relieve pressure. Engage gun trigger lock.

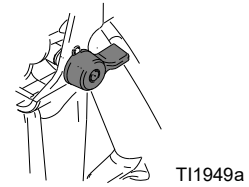

# Recirculate

## With Heat

**NOTE (Recirculating With Heat):** Using recirculation mode when heating the material is required. Note the temperature at the top of the primary Viscon HF fluid heaters (outgoing or back to hopper). When the thermometer and display reach operating temperature, the material is ready to spray.

## Without Heat



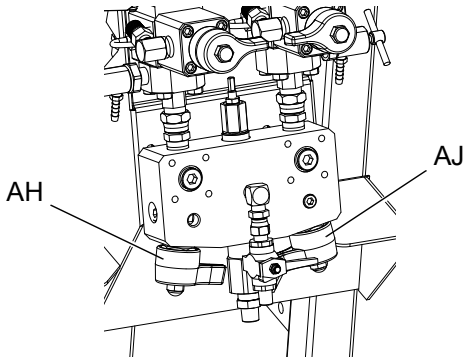

**NOTE (Recirculating Without Heat):** If using a system that does not require heat, recirculation is still required prior to spraying. Recirculation ensures that any settled fillers are mixed in, the pump lines are fully primed, and the pump check valves are operating smoothly.

1. Follow **Prime**, page 37.
2. Close mix manifold valves (AH, AJ).

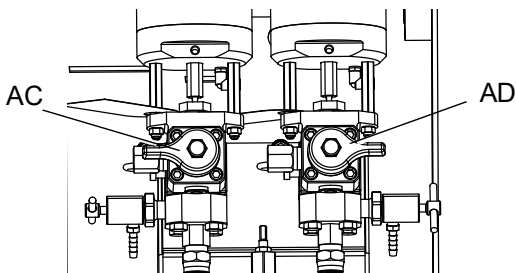

3. Ensure recirculation hoses are in the correct hoppers.
4. Open recirculation valves (AC, AD).



5. Select pumps to recirculate by pressing  to scroll through: , , or .

6. Turn on the main air shutoff valve (CA). Use system air regulator (CD) to slowly increase the air pressure to the pumps until they start running slowly.

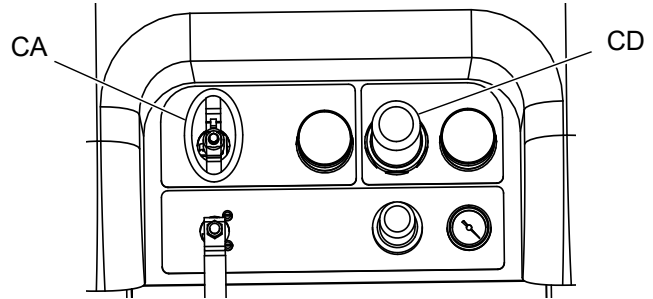

7. Run the pumps until the material has reached the desired temperature. Follow **Heat Fluid**, page 41.

8. Once desired temperature is reached, press .
9. Turn off the main air shutoff valve (CA).

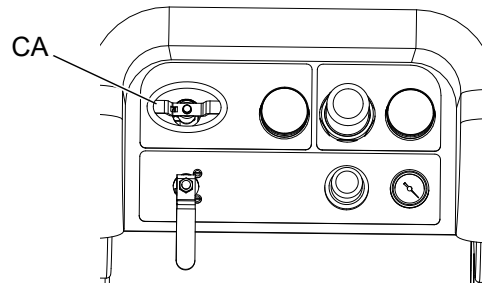

10. Close recirculation valves (AC, AD).

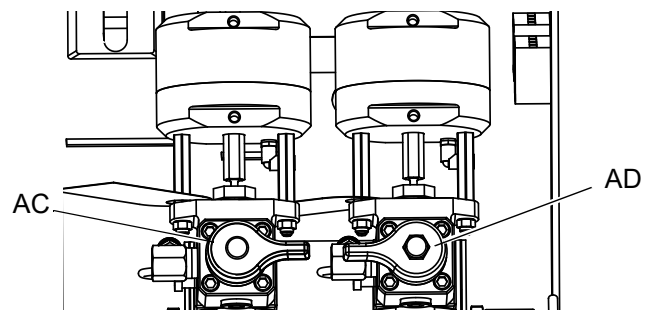

11. Follow **Spray**, page 42.

**NOTE:** If you circulate the A side pump at pressures greater than 3000 psi (21 MPa, 210 bar), an advisory is issued and the yellow LED on the display illuminates. This is a reminder to select Spray mode prior to spraying and to circulate at a lower pressure to avoid excessive pump wear.

If you circulate the A side pump above 5200 psi (35.4 MPa, 354 bar), an alarm shuts the pump down to prevent accidentally spraying material while still in circulation mode.



## Heat Fluid

To heat fluid evenly throughout the system:

1. Circulate fluid at approximately 1 gpm (10-20 cycles/min.) to raise temperature of hoppers to 80-90° F (27-32° C).
2. Decrease circulation rate to approximately 0.25 gpm (5 cycles/min.) to increase the heater outlet temperature to match the spray temperature.

**NOTE:** Circulating fluid too quickly without decreasing the circulation rate will increase only the hopper temperature. Similarly, circulating fluid too slowly will increase only the heater outlet temperature.

**NOTE:** Agitate, recirculate, and heat material only as necessary to avoid mixing air into the fluid.

# Spray



To help prevent injury from solvents and heated fluids, wear gloves when using solvents and/or if fluid temperature exceeds 110° F (43° C).

**NOTE:** Ensure that the pump spray pressure regulator is set to at least 35 psi (2.4 bar) for spraying.

**NOTE:** Ensure that the first gauge (supply) stays above 80 psi (0.55 MPa, 5.5 bar) while spraying.

After the first day of spraying follow **Pressure Relief Procedure**, page 44, and then tighten throat seals on both pumps and dosing valves.

1. If heaters are used, use Primary Heater Switches (BC) on the heater junction box to turn them on. To adjust heater temperature, refer to the Viscon HF manual for instructions, and the **Heat Fluid** section, page 41.

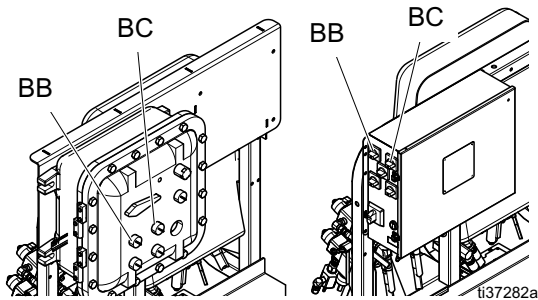

2. Close recirculation valves and mix manifold flush valve. Open mix manifold valves A (blue) and B (green).

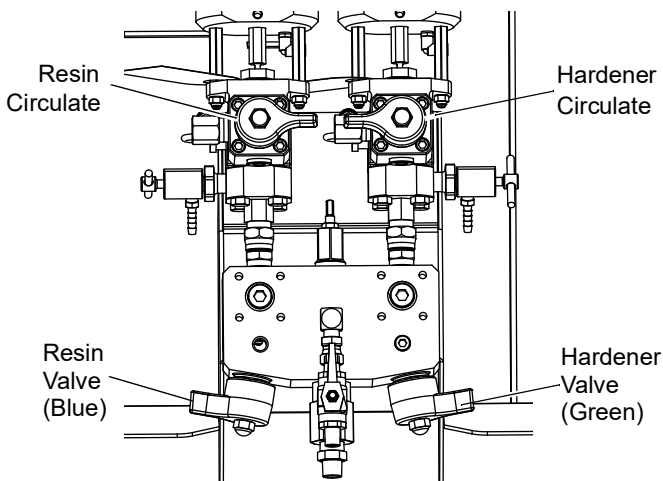

3. Adjust pump air regulator to 30 psi (0.21 MPa, 2.1 bar).

4. Select  . Press .

5. Disengage trigger lock and trigger gun into a grounded metal pail. Use a metal pail lid with a hole to dispense through to avoid splashing. Dispense flush solvent out of mix hose until a well mixed coating flows from the gun.

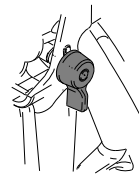

TI1950a

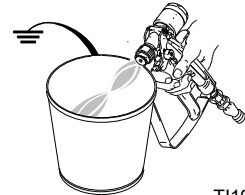

TI1953a

6. Engage trigger lock. Install tip on gun.



TI1949a

7. Adjust air regulator (CD) to the necessary spraying pressure and apply coating to a test panel. Look at ratio screen to ensure it is reading the correct ratio.

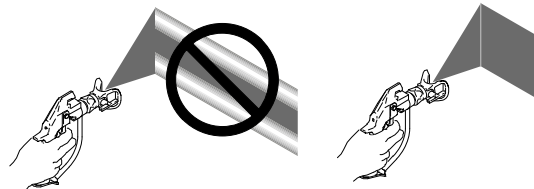

Also, look at bar graph to ensure mix manifold restriction adjustment is within optimal range. Refer to **Batch Dispense or Ratio Test**, page 55 and **Adjust B Machine Outlet Restriction**, page 43.

8. Follow **Flush Mixed Manifold, Hose, and Spray Gun**, page 45, or **Park Fluid Pump Rods**, page 51, when you are finished spraying or before potlife expires.

**NOTE:** Mixed material potlife or working time decreases with increased temperature. Pot life in hose is much shorter than dry time of coating.

# Adjust B Machine Outlet Restriction

Adjust the restriction stem on mix manifold, or on restrictor valve if mix manifold is remote, to optimize the B side dosing control window. The goal is to create a near constant flow on the A side and frequent dosing or a near constant flow on the B side.

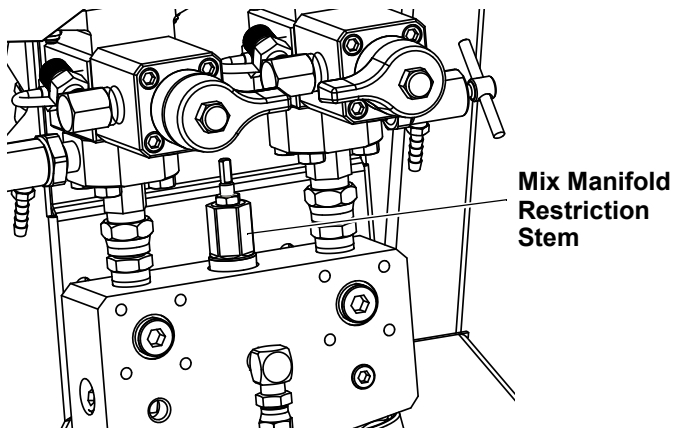

1. With material at normal spray temperature and tip installed on spray gun, trigger gun for at least 10 seconds.
2. Navigate to Ratio Mode screen. See **Ratio Mode**, page 87. Check bar graph.

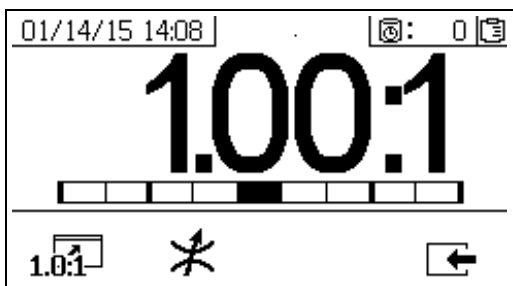

The ratio bar graph is shown when  $1.0:1$  is pressed. This screen is used to show the accuracy of the spray ratio. The bar should be in the center three segments when the restrictor is adjusted.

3. Press  $*$  to go to the restrictor adjustment screen.

- For remote mix manifolds, set the machine restrictor first. Then close the remote mix manifold restrictor to approximately the same setting, or until the restrictor screen starts to move to the left.
- It is normal for the bar to move on the graph while spraying. If the adjustment is too far off, you will receive an alarm. If the ratio will not hold, you will receive alarm R4BE or R1BE. See **Alarm Codes and Troubleshooting**, page 65.
- If the bar swings back and fourth and you are using feed pumps, the feed pressure may be too high. Keep feed pressure under 250 psi (1.75 MPa, 17.5 bar). High pressure pumps receive a pressure boost that is twice the pressure feed on the upstroke only. High feed pressures can cause pressure swings between A and B. The system will compensate, but the bar graph will the show the swing.

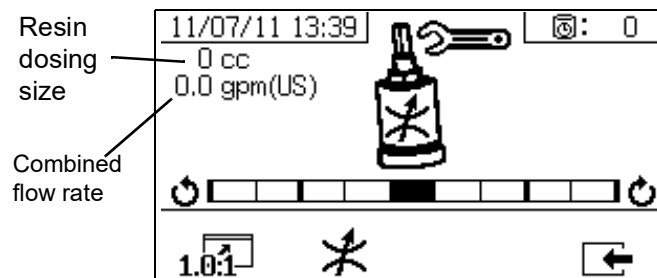

The restrictor adjust bar graph is shown when  $*$  is pressed. This screen is used to adjust the restrictor.

- At maximum fluid flow, the bar should be in the center.
- At flows less than maximum, the bar should be on the right side.
- The bar should never be on the left.
- Configure the system at maximum fluid flow. Then turn the restrictor clockwise if the bar graph is on the right and counter-clockwise if the bar graph is on the left.

**NOTE:** A pump dosing size, shown on the upper left corner, will be minimum when the restrictor is adjusted correctly. Once the restrictor is set for a given ratio and material, it should be locked in place and left alone.

# Pressure Relief Procedure



Follow the Pressure Relief Procedure whenever you see this symbol.

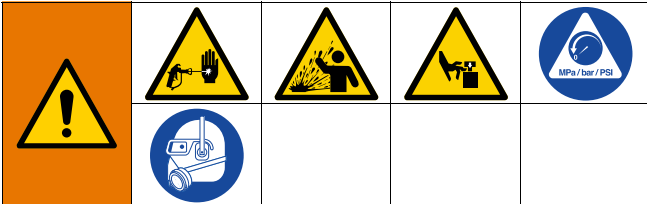

This equipment stays pressurized until pressure is manually relieved. To help prevent serious injury from pressurized fluid, such as skin injection, splashing fluid and moving parts, follow this Pressure Relief Procedure when you stop spraying and before cleaning, checking, or servicing the equipment.

## Relieve A and B Fluid Pressure

1. Engage trigger lock.

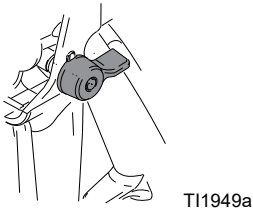

2. Press .

3. If fluid heaters are used, use Primary Heater Switches (BC) on the junction box to turn them off.

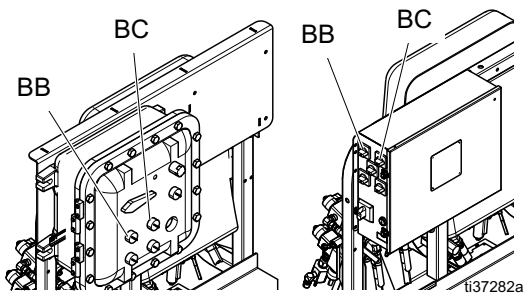

4. If the feed pumps are being used, shut them off by closing the feed pump air regulator and close the feed pump air valve.

5. Disengage trigger lock.

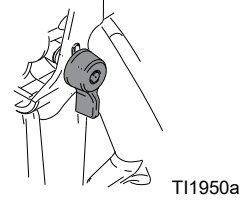

6. Hold a metal part of the gun firmly to a grounded metal pail with a splash guard in place. Trigger gun to relieve pressure in material hoses.

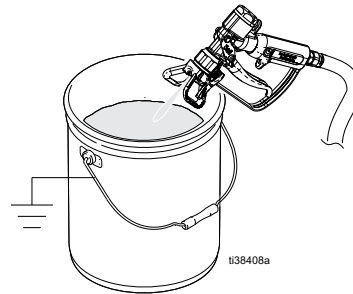

7. Engage trigger lock.

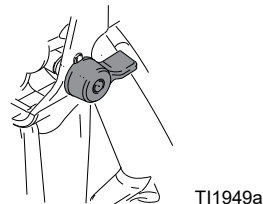

8. Close mix manifold valves (AH, AJ).

**NOTICE**

To prevent material from curing in the fluid lines and causing damage to the equipment, always flush the mix hose after relieving A and B fluid pressure through the mix manifold. Follow **Flush Mixed Manifold, Hose, and Spray Gun**, page 45, when you stop spraying or dispensing, and before cleaning, checking, servicing, or transporting equipment.

# Flush

## Flush Mixed Manifold, Hose, and Spray Gun

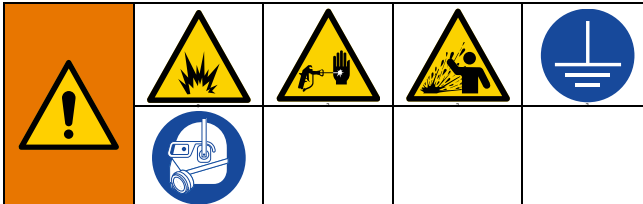

To avoid fire and explosion, always ground equipment and waste container. To avoid static sparking and injury from splashing, always flush at the lowest possible pressure.

Hot solvent may ignite. To avoid fire and explosion:

- Flush equipment only in well-ventilated area.
- Ensure main power is off and heater is cool before flushing.
- Do not turn on heater until fluid lines are clear of solvent.

1. Press  to turn off system. Follow **Pressure Relief Procedure**, page 44. Engage trigger lock. Remove spray tip.

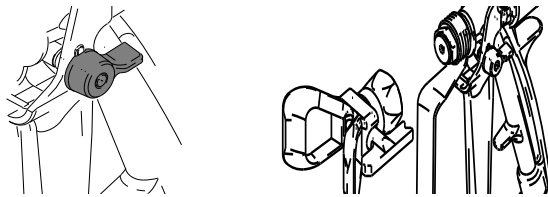

2. Make sure sampling valves (AE, AF) and mix manifold valves (AH, AJ) are closed.

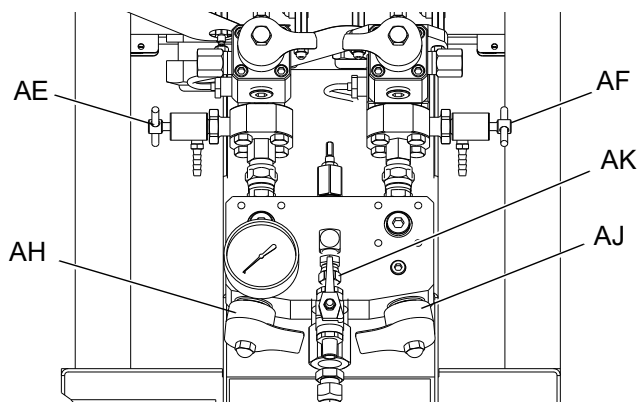

3. Open solvent shutoff valve (AK) at mix manifold.
4. Verify that the solvent pump air regulator (CG) is at 0 psi, then open solvent pump air control (CB). Pull out and slowly turn solvent pump air regulator (CG) clockwise to increase air pressure. Use lowest possible pressure.

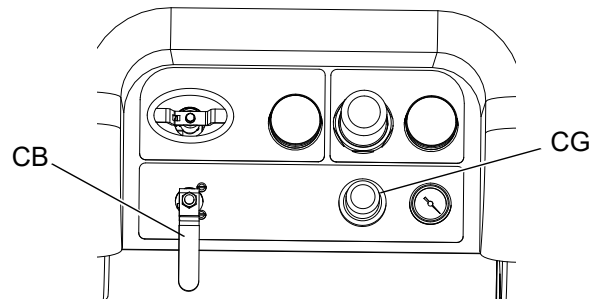

5. Disengage trigger lock. Hold a metal part of the gun firmly to a grounded metal pail with a splash guard in place. Use a pail lid with a hole in it to dispense through. Be careful to keep fingers away from the front of the gun. Trigger gun until clean solvent appears.

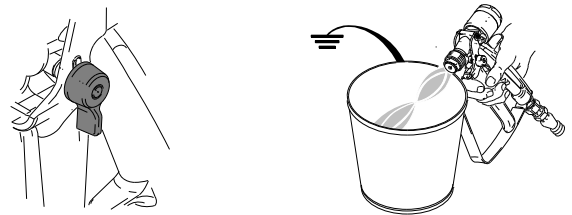

6. Close solvent pump air valve (CB).
7. Hold a metal part of the gun against a grounded metal pail and trigger the gun to relieve pressure. Close the solvent flush valve (AK) after relieving the pressure.

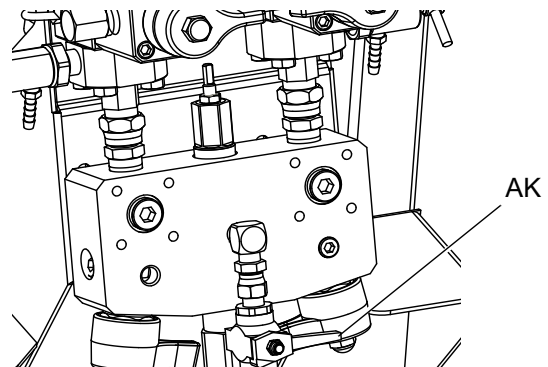

8. Engage trigger lock.
9. Disassemble and clean spray tip with solvent. Reinstall on the gun.

## Flush Hoppers

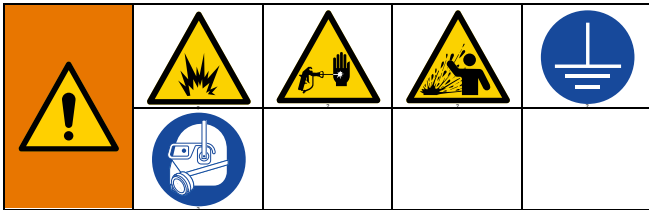

To avoid fire and explosion, always ground equipment and waste container. To avoid static sparking and injury from splashing, always flush at the lowest possible pressure.

Hot solvent may ignite. To avoid fire and explosion:

- Flush equipment only in well-ventilated area.
- Ensure main power is off and heater is cool before flushing.
- Do not turn on heater until fluid lines are clear of solvent.

1. If fluid heaters are used, use the hopper heater switches (BD) on the junction box to turn them off. Allow everything to cool before flushing.
2. Follow the **Flush Mixed Manifold, Hose, and Spray Gun** procedure on page 45.
3. Engage the trigger lock (TL).

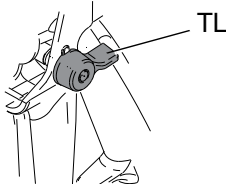

4. Turn the motor air pressure regulator (CD) fully counterclockwise to shut off.

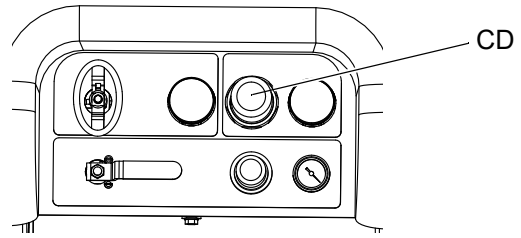

5. Move the recirculation lines (U) to separate grounded fluid containers.

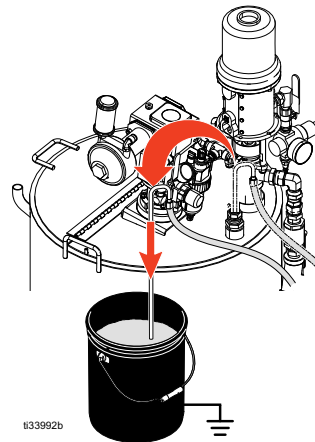

6. Open the recirculation valves (AC, AD).

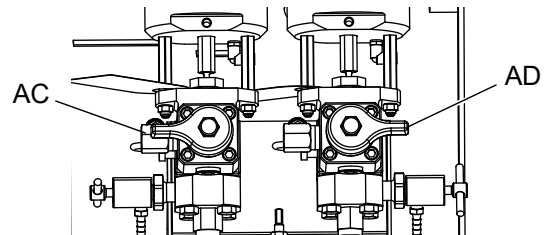

7. Open the feed pump air valve (EM) and begin to pump material out of the hopper. The feed pump may stall.

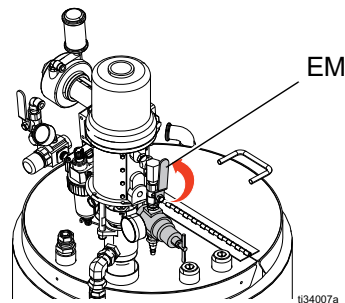

8. Select pumps to recirculate by pressing **ATB** to scroll through: **TA** , **TB** , or **ATB** .

9. Turn on the main air shutoff valve (CA). Use system air regulator (CD) to slowly increase the air pressure to the pumps until they start running slowly.

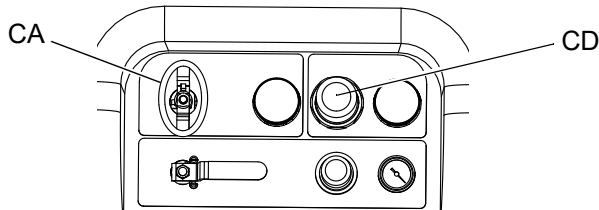

10. Run feed pumps until they are dry. Turn off the feed pump air valve (EM) and agitator air valve (EP).

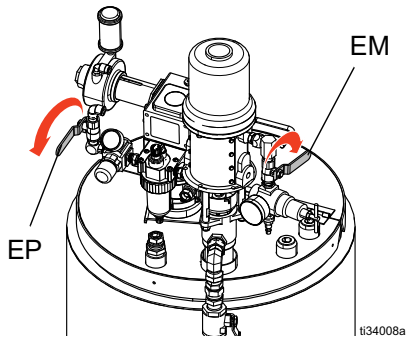

11. Run the main high pressure fluid pumps until the material has been emptied out of the system, press



12. Place a small pail under the hopper and open the material drain (EH) to fully drain the spray material.

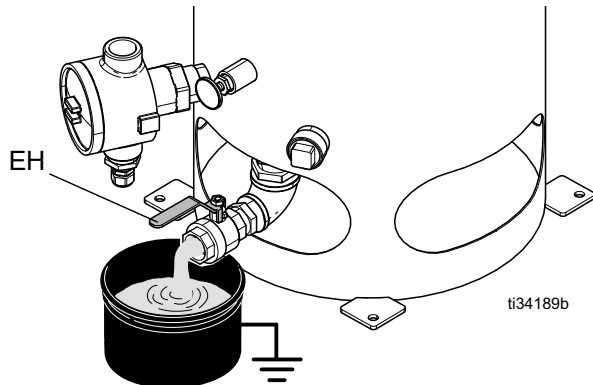

13. Close the material drain (EH) and fill the hopper with solvent.

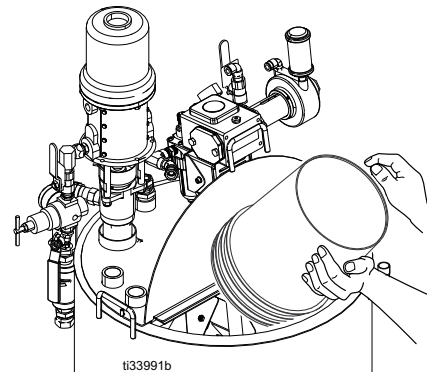

14. Return the circulation lines (U) to their respective hoppers.

15. Open on the agitator air valve (EP) and feed pump air valve (EM).

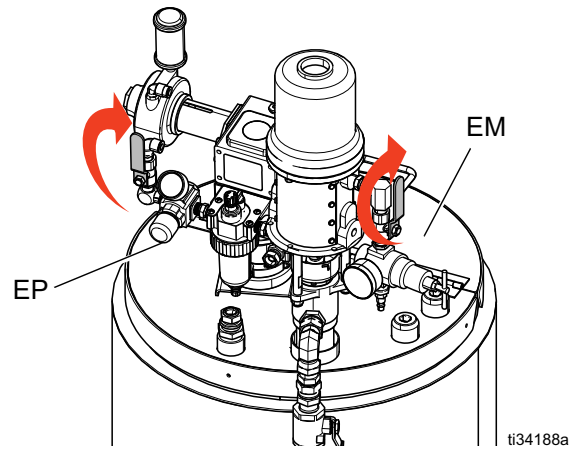

16. Select pumps to recirculate by pressing **ATB** to scroll through: **TA** , **TB** , or **ATB** .

17. Turn on the main air shutoff valve (CA). Use the system air regulator (CD) to slowly increase the air pressure to the pumps until they start running slowly. Circulate for two to three minutes.

Flush

18. Drain the material by moving circulation lines to a waste container or using the material drain (EH).

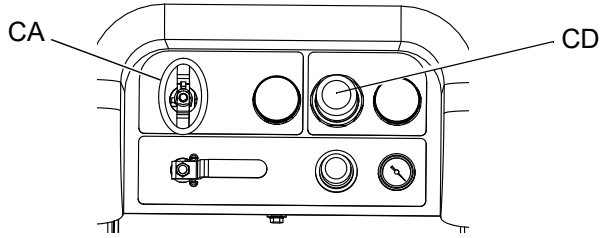

19. Repeat steps 13-18. Change the flushing solvent until it runs clean.

20. Turn off the main air shutoff valve (CA).

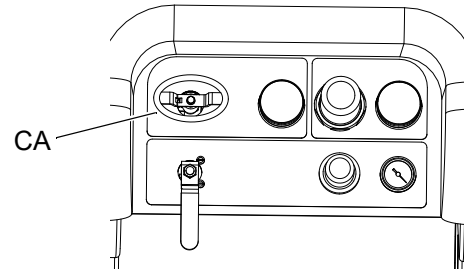



## Empty and Flush Entire System (new sprayer or end of job)

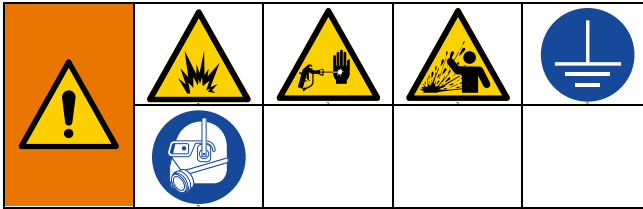

To avoid fire and explosion, always ground equipment and waste container. To avoid static sparking and injury from splashing, always flush at the lowest possible pressure.

Hot solvent may ignite. To avoid fire and explosion:

- Flush equipment only in well-ventilated area.
- Ensure main power is off and heater is cool before flushing.
- Do not turn on heater until fluid lines are clear of solvent.

### NOTE:

- If system includes heaters and heated hose, turn them off and allow to cool before flushing. **Do not turn on heaters until fluid lines are clear of solvent.**
- Use the lowest possible pressure when flushing to avoid splashing.
- Before color change or shutdown for storage, flush at a higher flow rate and for a longer time.
- To flush only mix manifold, follow the **Flush Mixed Manifold, Hose, and Spray Gun** procedure on page 45.

### Guidelines

Flush new systems if coating materials will be contaminated by 10W oil.

Flush system when any of the following situations occur. Flushing will help prevent materials from clogging the line between hoppers and pump inlets.

- Anytime sprayer will not be used for more than one week
- If materials used will settle
- If using thixotropic resins that require agitation

## Procedure

1. Follow **Pressure Relief Procedure**, page 44, and **Flush Mixed Manifold, Hose, and Spray Gun**, page 45. Engage trigger lock. Turn main pump air regulator (CD) fully counter-clockwise to shut off.

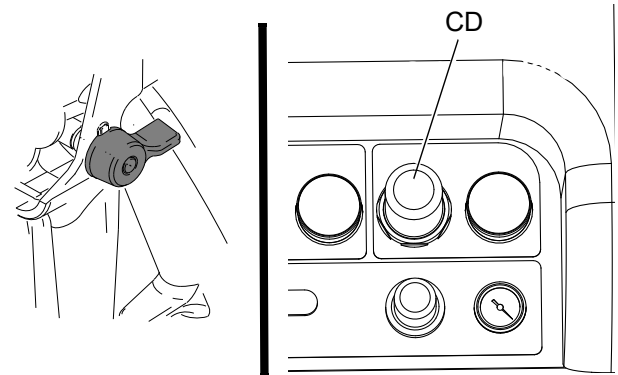

**NOTE:** When flushing coating materials, remove pump fluid filters, if installed, and soak in solvent to decrease cleaning time. If flushing a new system, leave filters in place. Proceed with Step 2.

2. Move circulation return lines to separate fluid containers to pump remaining fluid out of system.
3. Increase main pump air regulator (CD) pressure to 30 psi (21 kPa, 2.1 bar).

4. Select  . Press .

When running pumps independently set to  or

 . Press  and  as needed to clean.



**NOTE:** If sprayer does not start with static pressure, increase air pressure by 10 psi (69 kPa, 0.7 bar) increments. To avoid splashing do not exceed 40 psi (28 kPa, 2.8 bar).

Flush

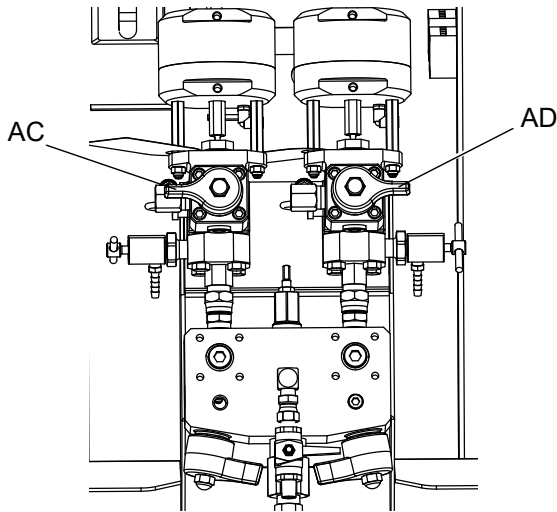
- Open recirculation valves (AC, AD) for respective pump dispense side. Run pumps until the A and B hoppers are empty. Salvage the material in separate, clean containers.





**NOTE:** When priming or flushing the pumps, it is normal to get cavitation or pump runaway alarms. Clear the

alarms , and press  again as necessary. These alarms prevent excessive pump speeds that can damage pump packings.

- Wipe hoppers clean, then add solvent to each. Move circulation lines to waste containers.
- Repeat Step 4, page 49, to flush through each side until clean solvent exits recirculation hose.
- Press . Move recirculation hoses back to hoppers. Continue recirculating until system is thoroughly flushed.

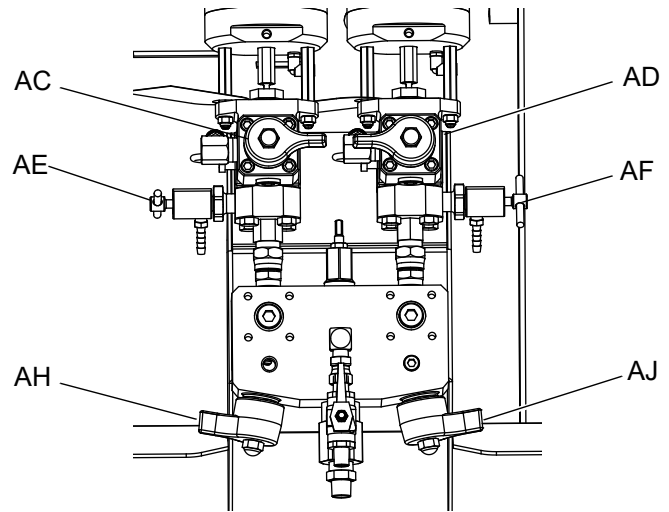
- Close recirculation valves (AC, AD) and open mix manifold valves (AH, AJ). Dispense fresh solvent through mix manifold valves and out gun.



- Close mix manifold valves (AH, AJ).
- Slowly open sampling valves (AE, AF) to flush solvent through until clean. Close sampling valves.  
Press .
- Follow **Park Fluid Pump Rods**, page 51.
- Remove pump fluid filters, if installed, and soak in solvent. Clean and replace filter cap. Clean filter o-rings and leave out to dry. Do not leave o-rings in solvent.
- Close main air valve (E).

**NOTE:** Fill A and B pump packing nuts with TSL. Also, always leave some type of fluid, such as solvent or oil, in the system to prevent scale build up. This build up can flake off later. Do not use water.

# Park Fluid Pump Rods

**NOTICE**

If fluid is allowed to dry on the exposed displacement rod, damage to the throat packings may occur. To prevent damage, always stop the feed pump at the bottom of the stroke.

1. Relieve pressure. Follow **Pressure Relief Procedure**, page 44.
2. Press  .
3. Turn recirculation valves (AC, AD) counter clockwise to open them. Each pump will run through recirculation until they reach the bottom stroke, and then stop.

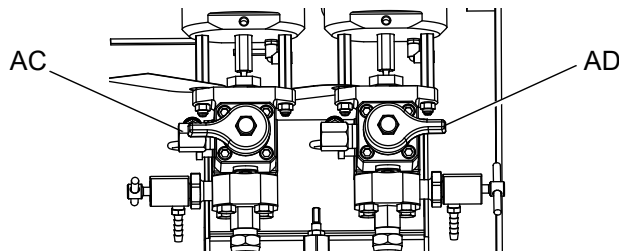

4. When each blue pump LED turns off, close the corresponding circulation valve.

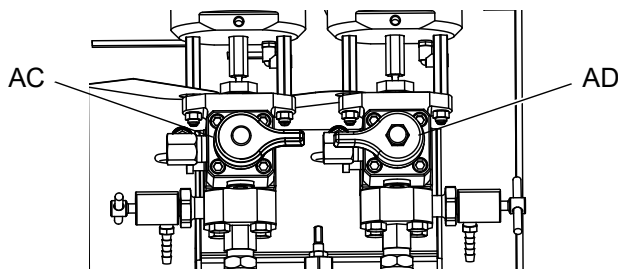

5. Shut off main pump air valve (CA) and air supply to entire system.

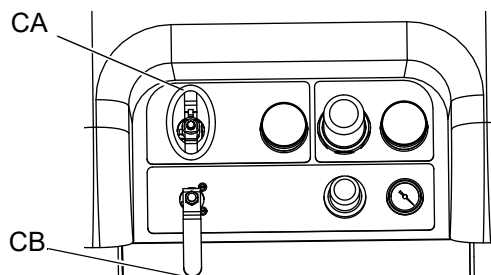

# Shutdown Entire System

Follow this procedure prior to servicing equipment or shutdown.

1. Follow **Flush Mixed Manifold, Hose, and Spray Gun**, page 45.
2. Engage trigger lock, turn off air regulator, and close main air shutoff valve. Remove spray tip.

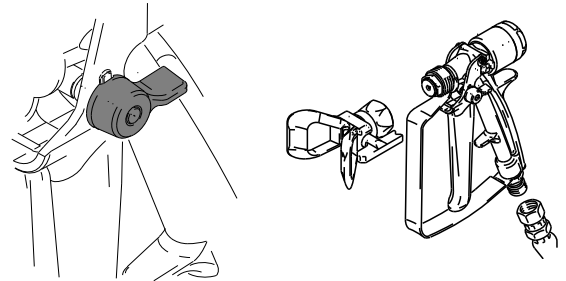

3. If the unit will be shut down for more than 24 hours:
  - Follow **Park Fluid Pump Rods** on page 51.
  - Cap fluid outlets to keep solvent in the lines.
  - Fill pump A and B packing nuts with throat seal liquid (TSL).
4. If the unit will be shut down for more than one week, follow **Empty and Flush Entire System (new sprayer or end of job)** on page 49.

# System Verification

Graco recommends running the following tests daily.

## Mix and Integration Tests



Use the following tests to check for proper mix and integration.

### Butterfly Test

At low pressure, normal flow rate, and without a spray tip installed, dispense a 1/2 in. (12.7 mm) bead of material onto foil until multiple changeovers of each pump have occurred. Fold the sheet of foil over the fluid then peel it back and look for unmixed material (appears marbled-like).

### Curing Test

Spray a single continuous pattern on foil at typical pressure setting, flow rate, and tip size until multiple changeovers of each pump have occurred. Trigger and de-trigger at typical intervals for the application. Do not overlap or cross over your spray pattern.

Check curing at various time intervals, listed on the material data sheet. For example, check for dry to touch by running your finger along the entire length of the test pattern at the time listed on the data sheet. NOTE: Spots that take longer to cure indicate insufficient integration.

### Appearance Test

Spray material onto metal substrate. Look for variations in color, gloss, or texture that may indicate improperly catalyzed material.

## Pump and Metering Test

This test checks the following items and should be run every time a new job is started, or if there is a suspected problem.

- Verifies that the pumps installed match the pumps selected on the Setup screen by dispensing exactly 750 ml of each material.

- Verifies that each pump holds fluid against the pump inlet valve by stalling on the down stroke.
- Verifies that each pump holds fluid against the pump piston valve and packings by stalling on the upstroke.
- Verifies that each dosing valve holds fluid, and that there are no external leaks between the pump and dosing valve.
- Verifies that the recirculation valves (AC, AD) are closed and do not leak.
- If system ratio mode is set by weight, this test calibrates the weight ratio.

This test will dispense 750 ml of component A, and then 750 ml of component B. Dispense into separate cups so the fluid can be returned to the supply tanks.

During each dispense the flow will stop once to stall the upstroke, once to stall the downstroke, and then it will finish the dispense. Do not close the sampling valve until the third flow stops and the blue pump light (DK) goes out.

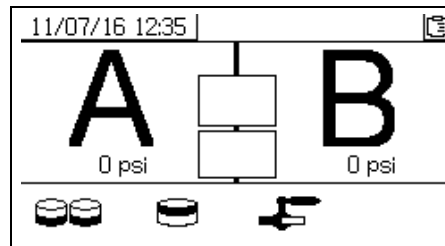

1. Enter the **Test Screens** (see page 87).

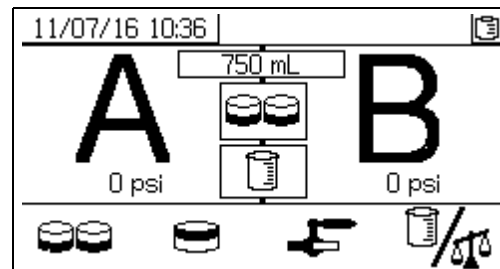

2. Select  to run pump test.



If the system ratio mode is by volume, either volumes or weights can be measured.

Press  to select this.  represents volume, which is standard on XM systems.

3. Set main pump air regulator (CD) pressure to zero. Open main pump and air valve (CA). Adjust main pump air regulator (CD) pressure to 50 psi (0.35 MPa, 3.5 bar).

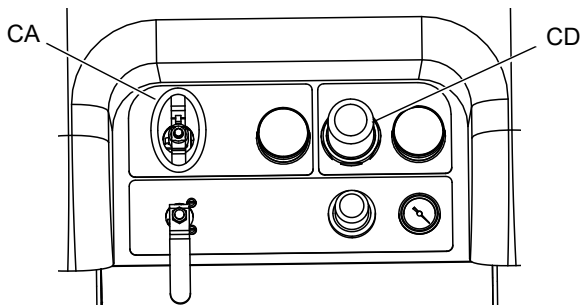

4. Dispense fluid A:
  - a. Close recirculation valves (AC, AD), mix manifold valves (AH, AJ), and both sampling valves (AE, AF).

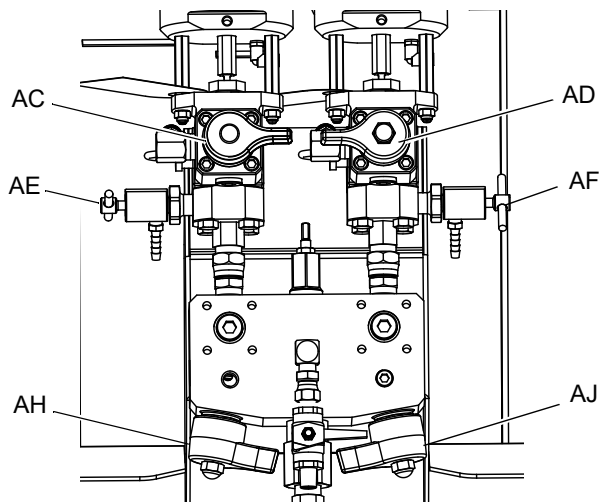

- b. Place a clean 1 quart (1000 cc) container under sampling valve A (AE).

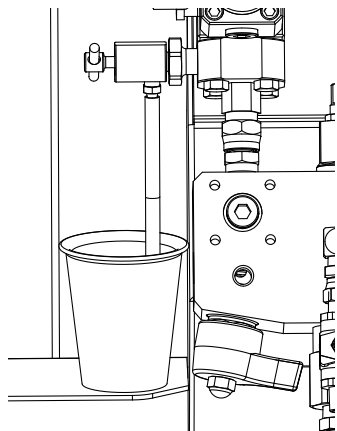

- c. Press . Pump A light (DK) comes on.

- d. Slowly open and adjust sampling valve A (AE) to achieve desired flow. Pump stops automatically; twice during test and again when dispense completes. Pump A light (DK) turns off, Pump B light (DK) turns on.

5. Close sampling valve A (AE).

6. Dispense fluid B as follows:

- a. Place a clean 1 quart (1000 cc) container under sampling valve B (AF).

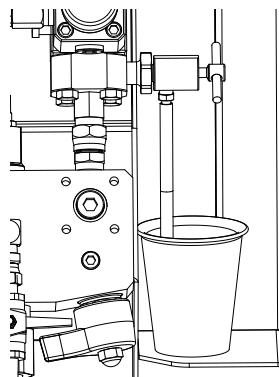

- b. Slowly open and adjust sampling valve B to achieve desired flow. Pump stops automatically; twice during test and again when dispense completes. Pump B light (DK) turns off.

- c. Close sampling valve B (AF).

7. Compare fluid amounts in containers; they should be equal at 750 ml (25.3 fl. oz.) each. Repeat test if fluids are not equal. If problem persists, see **Alarm Codes and Troubleshooting**, page 65

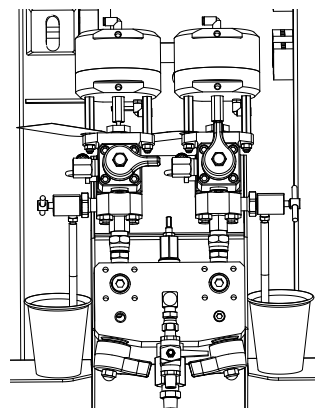

8. Return fluid used in test to corresponding fluid supply container.

### Confirm Pump and Metering Test

The Confirm Pump and Metering Test screen displays when the pump and metering test completes without error. Depending on the system ratio and test modes, the details of the screen can vary. See Appendix A, Test Screens (page 87) for these variations. The information here is for system ratio mode by volume and a test volume which is standard for XM systems. The screen displays the target volume of material dispensed into each beaker from each metering pump. To determine if the system is in ratio and have your test results entered in the downloadable USB log files, enter the two volumes.

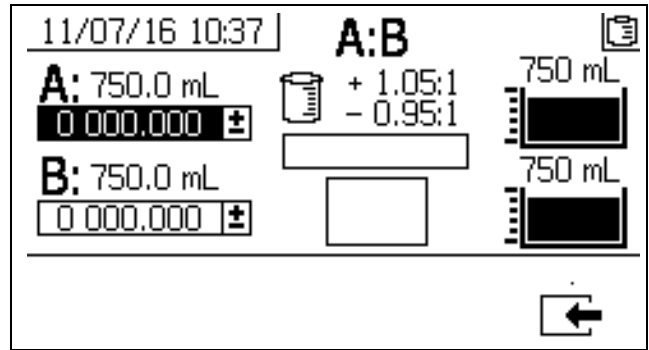

## Batch Dispense or Ratio Test

This test dispenses a calculated volume of each fluid based on ratio. The two fluids combined equal the batch size selected.

Follow this procedure to dispense a batch (into one container) for touch-up work or to verify a ratio setting (use separate containers for fluids A and B).



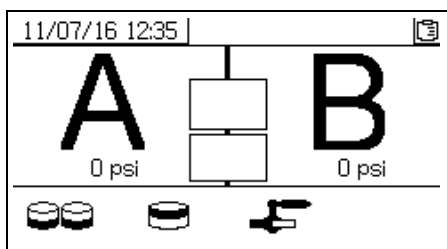

Dispense into a container with graduations no greater than 5% of each component. If the ratio is known by weight, use a scale for greatest accuracy.

1. Enter the **Test Screens** (page 87).

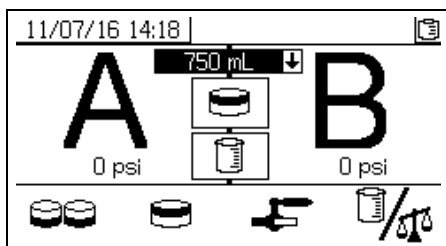

2. Select  to run batch dispense test.



3. Adjust dispense amounts from 500 ml to 2000 ml (in 250 ml increments) by pressing  to open the drop-down box. Then press  and  to select the desired value. Press  to select that value.
4. Set main pump air regulator (CD) pressure to zero. Open main pump and air valve (CA). Adjust main pump air regulator (CD) pressure to 50 psi (0.35 MPa, 3.5 bar).

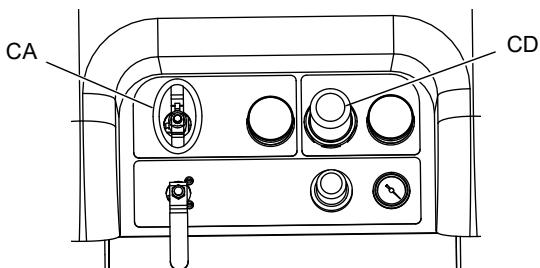

5. Close recirculation valves (AC, AD), mix manifold valves (AH, AJ), and sampling valves (AE, AF).

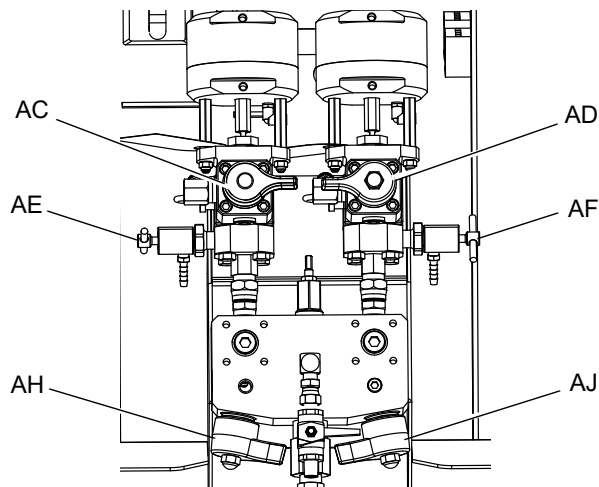

6. Place a clean container under sampling valve A (AE).

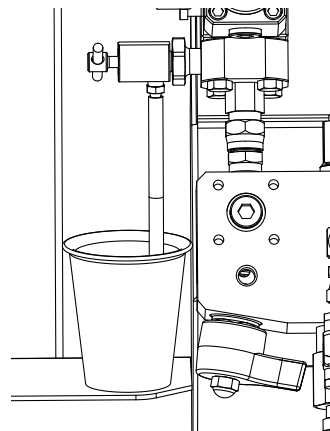

7. Press . Pump A light comes on.
8. Dispense fluid A. Slowly open and adjust sampling valve A (AE) to achieve desired flow. The pump stops automatically when dispense completes. Pump A light (DK) turns off, Pump B light (DK) turns on.
9. Close sampling valve A (AE).

10. Dispense fluid B as follows:

- a. *Batch dispense:* move container under sampling valve B (AF).

*Ratio check:* place clean container under sampling valve B (AF).

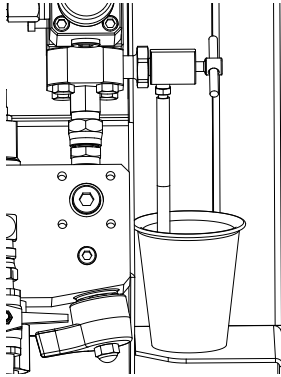

- b. Slowly open and adjust sampling valve B (AF) to achieve desired flow. The pump stops automatically when dispense completes. Pump B light (DK) turns off.
- c. Close sampling valve B (AF).

- 11. *Batch dispense:* stir material until mixed.  
*Ratio check:* compare A and B fluid dispensed.

**Confirm Batch Dispense Test**

The Confirm Batch Dispense Test screen displays when the batch dispense test completes without error. This screen displays the selected ratio between the metering pumps and the volume of material dispensed from each metering pump.

The gray at the bottom of the beaker represents the volume of material dispensed by metering pump A and the black at the top of the beaker represents the volume of material dispensed by pump B.

Enter the volume of each sample in the A and B input boxes. The system will calculate the ratio and display a

check in the box if it is within tolerance. The result of the test is also entered in the USB log.

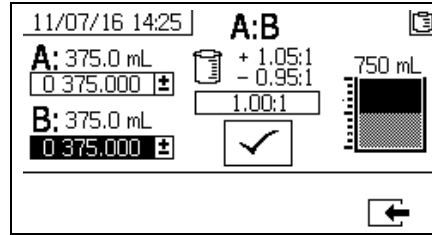

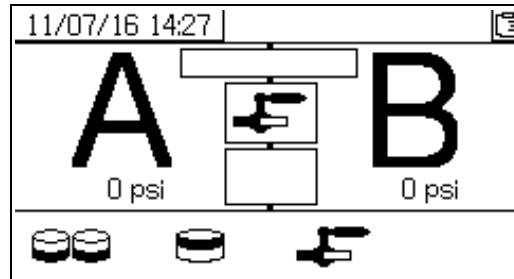

**Down Stream Valve Leak Test**

This test confirms or troubleshoots leaks in components located down stream of the dosing valves. Use this test to detect closed or worn valves, and to detect leaks in circulation valves installed at a remote mix manifold.



1. Close both mix manifold valves downstream of the dosing valves.
2. Close recirculation valves (AC, AD).
3. Enter Test mode in the run (fluid control) screen.

See **Test Screens** on page 87. Select  to run down stream valve leak test.

4. Select . Press . Ensure dosing valves (AA, AB) are open by verifying blue LEDs are illuminated for both dosing valves.
5. If test is successful, both pumps will stall against the down stream valves when the dosing valves (AA, AB) are open. If any movement is detected in the pumps after stalling, an alarm is issued indicating which side has a leak.



# Download Data from USB

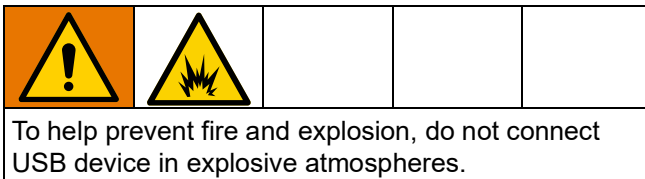

## USB Logs

By default, the ratio spray logs record data every 60 seconds. This 60 second interval will record about 32 days of data if spraying 8 hours per day, 7 days per week. To change the default, follow **Download Setup**, page 57. This log can hold up to 18000 lines of data.

### Ratio Log 1

(Default log for download.) The ratio log records date, time, machine number, job number, ratio target, ratio, batch volume, and ratio type (volume/weight) while the system is in Spray mode.

### Spray Log 2

The spray log records key data while the system is in spray mode. It records A and B temperature, A and B pressure, A and B flow, A and B batch totals, ratios, restrictor adjustments, alarm codes, and commands.

Once the ratio or spray log is full, new data automatically overwrites old data.

After data in the ratio or spray log is downloaded it remains in the USB module until it is overwritten.

### Event Log 3

The event log records all event codes generated over a two year period. This log should be used for troubleshooting purposes and cannot be deleted. This log can hold up to 39000 lines of data.







### Data Log 4

The data log records (every 120 seconds) all data that occurs during spray mode over a two year period. This log should be used for troubleshooting purposes and cannot be deleted. This log can hold up to 43000 lines of data.

The 120 second recording period cannot be adjusted.

To cancel download, press  while in process. Wait

## Download Setup

Navigate to the System Setup screen. Change the number of hours of recorded data to download (default is 768 hours), by pressing  and  to move to . Press  to make the field selectable. Press  to scroll through each digit. Press  to save the new digit. Follow the same procedure to change the time interval at which data will record (default is 60 seconds). Exit the System Setup screen.

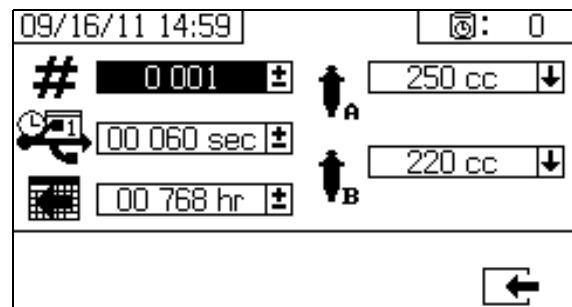

## Download Procedure

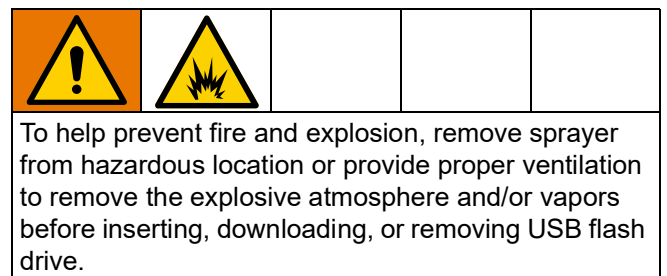

1. Insert USB flash drive into USB port (DR). Use only Graco-recommended USB flash drives; see **Recommended USB Flash Drive**, page 93.

Inserting the USB flash drive while the sprayer is running will stop sprayer operation.

2. The USB download screen automatically displays, and the selected log(s) automatically downloads. The USB symbol flashes to indicate download is in process.

for USB icon to stop flashing, and then remove USB flash drive.

## Download Data from USB

3. The USB icon stops flashing when download completes. The box below displays , which indicates the download was successful

4. Remove USB flash drive from USB port (DR).



To help prevent fire and explosion, never leave USB flash drive in USB port (DR).

5. Insert USB flash drive into USB port of computer.
6. The USB flash drive window automatically opens. If it does not, open USB flash drive from within Windows<sup>®</sup> Explorer.
7. Open Graco folder.

8. Open sprayer folder. If downloading data from more than one sprayer, there will be more than one sprayer folder. Each sprayer folder is labeled with the corresponding USB serial number.

9. Open DOWNLOAD folder.

10. Open folder labeled with the highest number. The highest number indicates the most recent data download.

11. Open log file. Log files open in Microsoft<sup>®</sup> Excel<sup>®</sup> by default. However, they can also be opened in any text editor or Microsoft<sup>®</sup> Word.

**NOTE:** All USB logs are saved in Unicode (UTF-16) format. If opening the log file in Microsoft Word, select Unicode encoding.

# Maintenance

## Filters

Once a week check, clean, and replace (if needed) the following filters. Be sure to follow the **Flush**, page 45, prior to performing filter maintenance.

- Both pump filters; see your pump manual for instructions.
- Main air inlet manifold filter; see your sprayer repair manual, Replace Air Filter Element section, for instructions.
- Air regulator filter (5 micron) on air control assembly; see your sprayer repair manual, Replace Air Filter Element section, for instructions.
- B side mix manifold strainer; see your mix manifold manual.

## Seals

Once a week, check and tighten throat seals on both pumps and dosing valves. Be sure to follow **Flush Mixed Manifold, Hose, and Spray Gun**, page 45, prior to tightening seals.

## Cleaning Procedure



1. Ensure all equipment is grounded. Follow , page 16.
2. Ensure the area where the sprayer will be cleaned is well ventilated; and remove all ignition sources.
3. Turn off all heaters and allow equipment to cool.
4. Flush mixed material. Follow **Flush Mixed Manifold, Hose, and Spray Gun** procedure on page 45.
5. Relieve pressure. Follow **Pressure Relief Procedure**, page 44.
6. Shutdown sprayer and turn off all power. Follow **Shutdown Entire System**, page 51.
7. Clean external surfaces only using a rag soaked in solvent that is compatible with the spray material and the surfaces being cleaned.
8. Allow enough time for solvent to dry before using sprayer.

# Hopper

## Clean Inlet Strainer Screen



The inlet strainers filter out particles that can plug the pump inlet check valves. Inspect the screens daily as part of the startup routine, and clean as required.

1. Ensure that all pumps are shut off and close the Y-strainer valve (ES).
2. Place a container under the strainer base to catch drain off when removing the strainer plug.
3. Remove the screen from the strainer manifold. Thoroughly flush the mesh screen (MS) with compatible solvent and shake it dry.

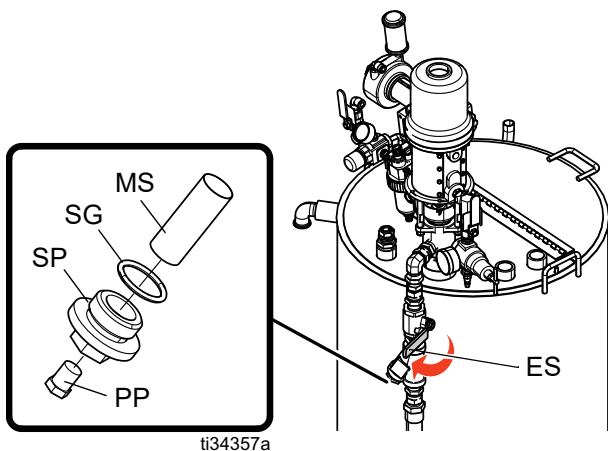

4. Inspect the screen. No more than 25% of the mesh should be restricted. If more than 25% of the mesh is blocked, replace the screen. Inspect the gasket and replace as needed. See your heated hopper manual for replacement components.
5. Ensure that the pipe plug (PP) is screwed into the strainer plug (SP). Install the strainer plug (SP) with the mesh screen (MS) and gasket (SG) in place and tighten. Do not over tighten the strainer plug--let the gasket make the seal.
6. Open the Y-strainer valve (ES). Ensure that there are no leaks and wipe the equipment clean.

## Check Heating Fluid Level

Gradual fluid evaporation can occur. Check the level of heating fluid monthly. Add fluid as needed.

**NOTICE**

Freezing temperatures can cause damage that may result in the heating fluid leaking into the terminal enclosure. To avoid damage, do not expose the unit to freezing conditions.

## Drain Heating Fluid

Replace heating fluid once a year to improve heating efficiency and increase heater element life. Keep the heating element above the sediment deposits. Sediment deposits will drain out from the heating fluid drain valve (EJ).

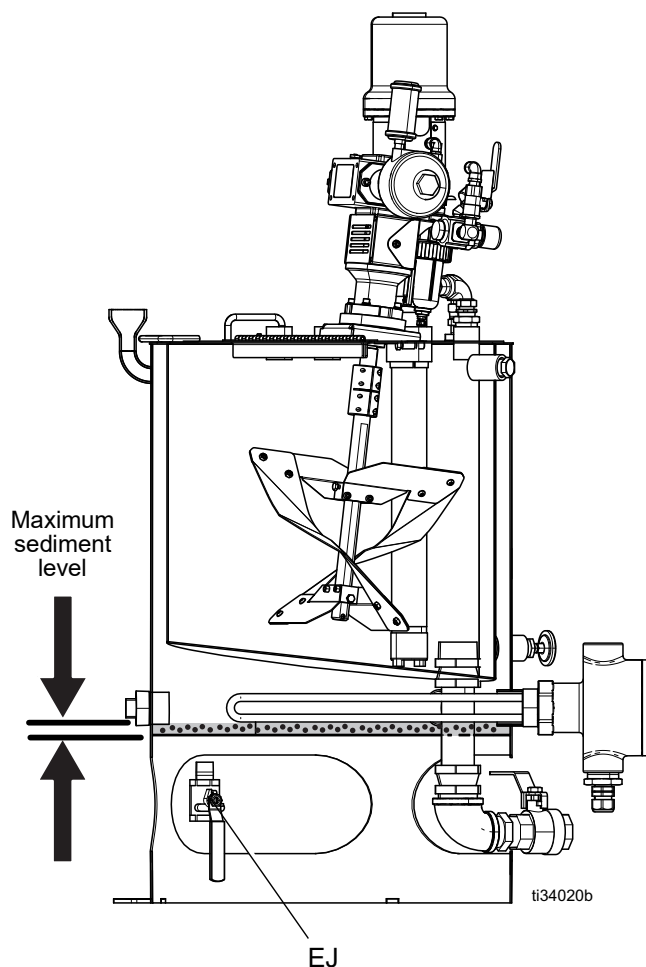

**NOTE:** The immersion heater will not operate in sediment deposits.

## Feed Pumps



- Keep the packing nut/wet-cup half filled with Graco Throat Seal Liquid (TSL™) or compatible solvent to help prolong packing life.

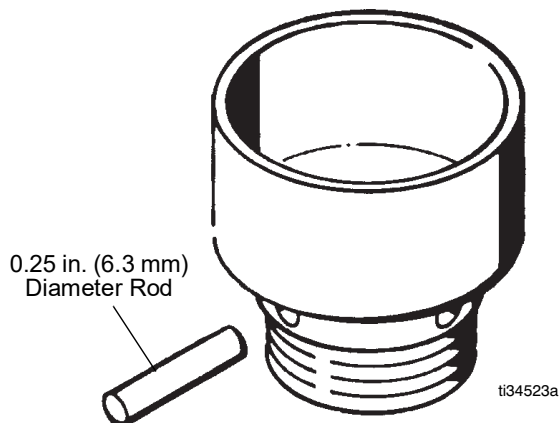

- Adjust the packing nut weekly so it is just tight enough to prevent leakage. Use a spanner wrench or a 0.25 in. (6.3 mm) diameter rod to tighten the nut. Do not over-tighten.

- Never leave the pump or hoses filled with water or air. To help prevent corrosion, flush the water and all air out of the system and leave it filled with mineral spirits or an oil-based solvent.

## Agitators

### NOTICE

To prevent air motor failure and possible damage to equipment, always keep the air motor properly lubricated using Air Motor Lubricant.

- After the first 100 hours, or two weeks of operation, change the gear reducer oil. After that, change the oil every 2500 hours, or six months (whichever comes first) of operation under normal conditions. More frequent oil changes are needed under severe operating conditions or in atmospheres containing excessive moisture or abrasives. See your agitator manual for the oil changing procedure.
- If the air motor is operating sluggish or inefficiently, flush the air motor (see your agitator manual).
- Every 2500 hours, or six months (whichever comes first) of operation, inspect the bearing block (see your agitator manual).

# XM Setup and Tips

Follow the **Initial System Setup** procedures starting on page 18 and **Basic Operation** procedures starting on page 33 to get the system ready to spray. Below are a few additional tips that will ensure your system keeps running smoothly

## Air Supply

- Ensure that the solenoid air filter/regulator behind the air panel is set to at least 80-85 psi. See **Alarm Codes and Troubleshooting** on page 65.
- Check that the air filter element in the solenoid air filter/regulator behind the air panel is clean.

## Calibration

- Adjust the B side fluid restrictor so that the calibration bar graph averages center to right middle. This means that the “B” dosing valve is open 25% to 75% of the time.
- Ensure dosing valve needle packing nuts are not adjusted too tight. They should be snug when there is no fluid pressure on the valve.

## Motor Icing

Air motors accumulate ice in the exhaust valving and muffler under hot and humid conditions or under cold ambient conditions. It can cause pressure loss or motor stalling.

- The ‘B’ fluid pressure should always be 15% to 30% higher than ‘A’ pressure.
- A larger pressure difference indicates ‘A’ motor icing.
- A smaller or negative pressure difference indicates ‘B’ motor icing.
- Ensure that the XL motor de-ice bleed valves are open to bleed warm air across the ice if icing becomes an issue.
- Ensure that the motor is left active when not spraying to keep the internal bleed air working. Leave the motor active in Spray mode or Manual mode to keep the bleed air on.

## Restrictions or Lost Pressure

- Always use filter screens in the XM pump lowers. Filter style pumps come with 60 mesh screens. Optional 30 mesh elements are also supplied.
- Always use a gun filter. 60 mesh is provided in the gun. Check that the static mixer is clean.
- Early mix manifolds (2009) had a 40 mesh screen on the B side. The screen could plug with materials that have filled ‘B’ side fluids.

## Remote Mix Manifold Applications

Ensure remote mix manifold outlet kit is installed. See XM Repair parts manual. The kit includes outlet check valves which isolate the pump pressure sensors from the outlet hoses, and includes a 'B' side restrictor valve for the machine outlet.

Early remote manifold machines didn't include the 'B' restrictor valve from the factory.

- Ensure that the 'A' and 'B' outlet hose sizes volume balanced close to the mix ratio. Unbalanced hose sizes can cause off ratio slugs at the mix manifold during pressure and/or flow transitions. See XM Mix Manifold Kits manual.

- If a minimum of integration and mix hose is used, ensure that "Fast Dosing" is selected in the setup screens

## Software Version

- Ensure all modules in the system use software from same token. Different software versions may not be compatible.
- The latest software version for each system can be found at Tech Support at [www.graco.com](http://www.graco.com).

## LED Diagnostic Information

The following LED signals, diagnosis, and solutions are the same for the display module, fluid control module, and USB module. LEDs are located next to the module power cable.

Module Status LED Signal	Diagnosis	Solution
Green on	System is powered up and power supply voltage is greater than 11 Vdc.	-
Yellow	Internal communication in progress	-
Red solid	Hardware failure	Replace display module, fluid control module, or USB module.
Red flashing fast	Uploading software	-
Red flashing slow	Token error	Remove token and upload software token again.

# Troubleshooting

**NOTE:** See your XM repair-parts manual for non-alarm based troubleshooting and repair instructions.

## Alarms

### View Alarms

When an alarm occurs the alarm information screen automatically displays. It shows the current alarm code along with a bell icon. It also shows the alarm location with top and side views of the sprayer.

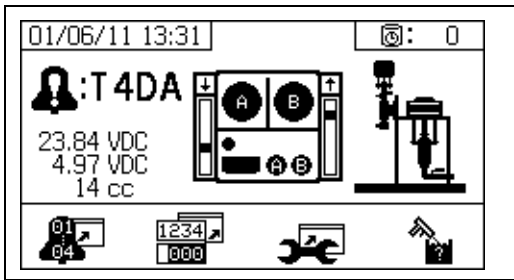

There are two levels of alarms: warnings and advisories. A bell icon indicates an alarm. A solid bell icon with an exclamation point and three audible alerts indicate a warning. And an outlined hollow bell icon and a single audible alert indicate an advisory.

Advisories are notifications that require attention but not immediately. Alarms require immediate correction; therefore, sprayer operation automatically stops.

This screen also shows diagnostic information. There are three lines of data on the left side. The top line shows the power supply. This should be:

- Non-Hazardous PFP: 23-25 Volts
- Hazardous PFP: 10-14 Volts

The middle line shows the voltage supplied to all sensors connected to the Advanced Fluid Control Module. This should be between 4.9-5.1 Volts.

The third line shows the A side pump dosing size. This value is displayed in volumes of cubic centimeters (cc)

and is the volume pumped on the A side when the B side dosing valve is off. Optimizing the restriction of the system will keep this value small and ensure the material is mixed well.

The center of the screen shows linear sensor vertical bar graphs and reed switch information. The A side information is on the left and the B side information is on the right. Linear sensor position is displayed on the bar graph that goes up and down when the pump moves. This bar graph should move from top to bottom to match each pump stroke.

The state of the two reed switches in each air motor are shown with the arrow above each vertical bar graph.

Icon	Function
	Moving up
	Moving down
	Top changeover
	Bottom changeover
	Both reed switches are active. Start of changeover or motor icing problem.
	Blank: No reed switch signal - error

### Diagnose Alarms

See **Alarm Codes and Troubleshooting** for causes and solutions to each alarm code.

### Clear Alarms

Press to clear alarms and advisories. From the

alarm information screen, press to return to the run (fluid control) screen.



## Alarm Codes and Troubleshooting

See XM Plural-Component Sprayers Repair-Parts manuals for non-alarm based troubleshooting.

Alarm Code	Alarm Problem	When Active	Cause	Solution
DAAX DABX	Pump runaway, above 80 cpm for 10 sec.	Always	No material in pump or lines; no fluid restriction.	Refill material in tank or hoses; install fluid tip.
DDAX DDBX	Pump cavitation; dives more than 1/2 of stroke.	Spray	No fluid or valve closed.	Refill supply and open inlet valve.
			Material is too cold or thick.	Increase material temperature to reduce viscosity. Follow <b>Heat Fluid</b> , page 41. Shear material with agitation to reduce viscosity.
			Pump inlet check valve not closing.	Clear debris from check valve. Or replace ball, seat, and seal.
			Feed pump not providing material.	Check feed pump (if used).
			Inlet strainer plugged (if used).	Check and clean strainer. See your proportioner repair manual.
F7AX F7BX	System Detects Unexpected Pump Movement (Fluid Flow).	Spray	Recirculation valve or dosing valve open or leaking for more than five seconds.	Close or repair recirculation valve, and run Pump Test. Follow <b>Pump and Metering Test</b> , page 52.
F8RX	No movement occurred in circulation mode	Circulation	Pump did not move for 5 seconds while in circulation. User may have attempted to spray in circulation mode.	Use spray mode for spraying.
P1AX P1BX	Pressure low.	Spray, Pump Test, Leak Test	Fluid pressure is below 1000 psi (7 MPa, 70 bar) for spray mode, or below 1500 psi (10.3 MPa, 103 bar) for test modes).	Increase main air regulator.
P4AX P4BX	Pressure high.	Always	Fluid pressure is above maximum.	Decrease main air regulator.
P4RE	Pressure high.	Recirculation	Pressure is above maximum advisory limit of 3000 psi (21 MPa, 210 bar) on A side.	Decrease pump air regulator pressure.
P5RE	Pressure high.	Recirculation	Pressure is above maximum warning limit of 5200 psi (35.9 MPa, 359 bar) on A side.	Decrease pump air regulator pressure.
P9AX	A pump pressure is abnormally low compared to B pump pressure.	Spray	A air motor is icing up causing restriction and lower fluid pressure.	Open the air motor de-ice bleed air controls. Allow ice to melt. Dry compressed air. Heat compressed air.
				Use a smaller tip.
			A pump is binding.	Repair lower. See manual your proportioner repair.
		A motor is hanging up.	Repair air motor. See your proportioner repair manual.	

Alarm Code	Alarm Problem	When Active	Cause	Solution
P9BX	B pump pressure is abnormally low compared to A pump pressure.	Spray	B air motor is icing up causing restriction and lower fluid pressure.	Open the air motor de-ice bleed air controls. Allow ice to melt. Dry compressed air. Heat compressed air.
				Use a smaller tip.
			B pump is binding.	Repair lower. See your proportioner repair manual.
QDAE	Dosing size A alarm	Spray	The fluid dosing size is greater than 45 cc when fast dosing is turned off.	Adjust the B side fluid restriction. Follow <b>Adjust B Machine Outlet Restriction</b> , page 43.
			The fluid dosing size is greater than 30 cc when fast dosing is turned on.	Decrease the air motor velocity with a smaller tip.
QTAE	Dosing size A advisory	Spray	The fluid dosing size is greater than 35 cc when fast dosing is turned off.	Adjust the B side fluid restriction. Follow <b>Adjust B Machine Outlet Restriction</b> , page 43.
			The fluid dosing size is greater than 20 cc when fast dosing is turned on.	Decrease the air motor velocity with a smaller tip.
R1BE	Ratio Low B (under dose B); system delivering not enough B component.	Spray	B dosing valve will not open.	Check for air signal to valve.
			B mix manifold valve closed.	Open green mix manifold valve.
			Pump filter plugged on B side.	Use alternate 30 mesh screen. See your pump manual for part number.
				Clean B pump outlet filter. See your pump manual.

Alarm Code	Alarm Problem	When Active	Cause	Solution
R4BE	Ratio High B (Overdose B), system delivering too much B component.	Spray	B Dosing valve not closing.	Perform Pump Test to test for leakage. Follow <b>Pump and Metering Test</b> , page 52.
			Loosen valve packing nut. See your proportioner repair manual.	
			Check air signal at valve top	
			Repair valve or air solenoid. See your proportioner repair manual.	
			No B restriction at mix manifold.	Increase B Restriction by turning B restrictor stem clockwise. Follow <b>Adjust B Machine Outlet Restriction</b> , page 43.
			Pump filter plugged on A side.	Clean filter. See manual 311762.
			Use alternate 30 mesh screen. See your pump manual for part number.	
			Inlet air dropping below 80 psi (0.55 MPa, 5.5 bar) while spraying. B dosing valve not closing correctly.	Check air filters. See manual 313289.
			Use larger air hose.	
			Use larger compressor.	
Use smaller gun tips or less guns to reduce flow rate.				
Solenoid air regulator set below 80 psi (0.55 MPa, 5.5 bar)	Adjust air regulator.			
R5BE	Dosing sizes are not optimized.	Spray	Dosing valve is operating near high or low timing limits.	Adjust mix manifold B restrictor stem clockwise or counter clockwise as indicated by bar graph on restrictor screen. Follow <b>Adjust B Machine Outlet Restriction</b> , page 43.
R5DX	Uncalibrated system in Weight Mode	Spray	System was not calibrated.	Run the <b>Pump and Metering Test</b> , page 52, and <b>Batch Dispense or Ratio Test</b> , page 55 to calibrate system for weight mode. Run system in volume mode.
Run system in volume mode.				
R9BE	System detected five R4BE (ratio high B) or five R1BE (ratio low B) alarms within five minutes. Sprayer shuts down for five minutes to resolve problem.	Spray	See R4BE or R1BE alarm causes.	See R4BE or R1BE alarm solutions. Flush mixed material if necessary, and purge off-ratio mixed material in hose.

Alarm Code	Alarm Problem	When Active	Cause	Solution
<b>Pump Test (Daily Check Recommended)</b>				
DEAX DEBX	Pump does not move in 10 minutes.	Park or Pump Test	Recirculation valves were not opened to allow flow.	Open recirculation valves.
DFAX DFBX	Pump did not stall against fluid pressure on up stroke only.	Pump Test	Pump piston check valve, piston packings, or dosing valve are not holding fluid pressure.	Flush pump. Follow <b>Empty and Flush Entire System (new sprayer or end of job)</b> , 49. Recheck. Remove, clean, and repair lower. See manual 313289.
DGAX DGBX	Pump did not stall against fluid pressure on down stroke only.	Pump Test	Pump inlet check or dose valve is fouled, or damaged.	Remove inlet housing & clean and inspect.  See your proportioner repair manual.
<b>General System Component Alarms</b>				
CACP	Display has no signal.	Always	No display communication signal.	Check cable connections. Replace display.  See your proportioner repair manual.
			Machine powered down in spray mode.	Press stop button before turning off power.
DJAX DJBX	Pump motor linear sensor has no signal.	Always	No linear sensor signal from motor.	Swap A and B sensors. Replace sensor if problem follows sensor. See your proportioner repair manual.
			Linear sensor plugged in while power is on.	Power sprayer off and back on. Do not plug in linear sensor while power is on.
			Bad connection inside fluid control module.	Replace fluid control module. See your proportioner repair manual.
	Pump motor linear sensor is out of range.	Always	Linear sensor is beyond range.	Replace sensor or sensor magnet. See your proportioner repair manual.
			Sprayer is not properly grounded.	See , page 16.
DKAX DKBX	Pump motor reed switch failure; missing signals from both switches.	Always	Bad motor cable connections, or bad reed switch.	Swap A and B motor cables. Replace cable if problem persists. Otherwise replace reed sensor assembly. See your proportioner repair manual.
			Reed switch cable is plugged in while power is on.	Power sprayer off and back on. Do not plug in reed switch cable while power is on.
			Bad connection inside fluid control module.	Replace fluid control module. See your proportioner repair manual.

<b>Alarm Code</b>	<b>Alarm Problem</b>	<b>When Active</b>	<b>Cause</b>	<b>Solution</b>
F6AK	A air motor reed switch signal missing advisory.	Always	Reed switch does not see the air motor magnet.	Replace air motor reed switch magnet.
			Reed switches are bad.	Replace air motor reed switch. Prevent air motor icing. See advisory P9A and P9B.
			Air motor is icing up.	
F6BK	B air motor reed switch signal missing advisory.	Always	Reed switch does not see the air motor magnet.	Replace air motor reed switch magnet.
			Reed switches are bad.	Replace air motor reed switch. Prevent air motor icing. See advisory P9A and P9B.
			Air motor is icing up.	
F6AJ	A air motor linear sensor jump advisory.	Always	System ran out of fluid.	Add fluid to the system.
			Linear sensor is bad.	Replace linear sensor.
F6BJ	B air motor linear sensor jump advisory.	Always	System ran out of fluid.	Add fluid to the system.
			Linear sensor is bad.	Replace linear sensor.
P6AX P6BX	Pressure sensor failure; no signal.	Always	Pressure sensor or cable is bad on the side indicated.	Replace sensor and cable assembly. See your proportioner repair manual.
V2MX	Voltage low control.	Always	Voltage dropping below 9 Vdc from power supply.	Change air filter in control filter regulator. See your proportioner repair manual.
				Check the pressure setting is 18 psi (0.13 MPa, 1.3 bar) on turbine air regulator.
				Check voltage on information screen.
			Turbine not spinning with air on.	Replace air turbine cartridge. See your proportioner repair manual.
<b>Optional User-Settable Maintenance Warnings</b>				
*MAAX *MABX	Maintain pump.	Always, if enabled	Pump usage exceeds user-set limit. Maintenance due.	Service pump. See your proportioner repair manual.
*MEAX *MEBX	Maintain dosing valve.	Always, if enabled	Dosing valve usage exceeds user-set limit. Maintenance due.	Service dosing valve. See your proportioner repair manual.
*MGPX	Maintain air filter.	Always, if enabled	Air filter exceeds user-set limit. Maintenance due.	Service main air filter and control filter regulator. See your proportioner repair manual.
*P5AX *P5BX	Pressure exceeded alarm limits.	Spray	Pressure exceeded high or low alarm limits for more than 15 seconds.	Adjust pump pressure regulator, change tips, or adjust target set point.

Alarm Code	Alarm Problem	When Active	Cause	Solution
<b>Optional User-Settable Spray Limits</b>				
*P2AX P2BX	Pressure exceeded advisory limits.	Spray	Pressure exceeded high or low advisory limits for more than 15 seconds.	Same as P5A or P5B above.
*QPDX	Pot life timer expired. Mixed fluid will cure in hoses, mixer, and gun.	Spray	Have not sprayed enough volume to keep fresh mixed fluid in the integration hose, mixer, whip hose, and spray gun.	Spray fluid, or flush. Resets when you leave spray mode. Follow <b>Spray</b> , page 42, or <b>Flush</b> , page 45.
*T2DA T2DB	Temperature exceeded advisory limits.	Spray	Fluid temperature exceeded high or low limits for more than four minutes.	Same as T5A or T5B above.
*T5DA T5DB	Temperature exceeded alarm limits.	Spray	Fluid temperature exceeded high or low alarm limits for more than four minutes.	If fluid temperature is too low, return to circulation mode to increase fluid temperature. Adjust heater set point if needed. Follow <b>Heat Fluid</b> , page 41.
				If fluid temperature is too high, lower heater set point, and return circulation mode to cool. Follow <b>Heat Fluid</b> , page 41.
				Adjust temperature target setpoint. Follow <b>Heat Fluid</b> , page 41.

### Possible Alarms by Mode

The following table outlines the alarms that you may receive while operating the system. The alarms are categorized according to each mode.

Mode	Control Logic	Alarms
Spray	Dosing valves close for startup test; green light blinks.	--
	If fluid pressure is under 1000 psi (7 MPa, 70 bar), STOP.	P1AX
	If pumps move (indicating internal leakage), STOP.	F7AX, F7BX
	If fluid pressure is more than 103% of allowed maximum, air motor shuts off until fluid pressure drops.	None
	If is pressure more than 110% of allowed maximum, STOP.	P4BX
	Dosing valve A opens, and dosing valve B cycles to maintain ratio.	--
	A and B blue lights illuminate when dosing valves are operating.	--
	If there is not enough B component to hold ratio, dosing valve A closes momentarily.	R5BE
	If A or B component is more than 5% off ratio setpoint, STOP.	R1BE, R4BE
	If A dose size is too large, STOP.	QDAE
	A and B dosing valves close momentarily at each pump changeover.	--
	Spray mode turned on with system in Weight Mode and uncalibrated.	R5DX
Park	Both dosing valves open; A and B blue lights turn on.	--
	User opens circulation valves or sprays gun. When pump reaches bottom stroke the blue light turns off.	--
	If park does not complete in 10 minutes, turn off air to both motors.	DEAX, DEBX
Circulation	A and/or B dosing valves close and motor air turns on.	--
	If fluid pressure exceeds 3000 psi (21.0 MPa, 210 bar) on the A pump, receive yellow light advisory.	P4AX
	If fluid pressure exceeds 5600 psi (39.2 MPa, 392 bar) on the A pump, STOP.	P4AX
	If no movement in 10 minutes, turn off air to both motors.	DEAX, DEBX
	Pump did not move for 5 seconds while in circulation mode.	F8RX
Pump Test	Both dosing valves close; green light blinks.	--
	If fluid pressure is under 1000 psi (7.0 MPa, 70 bar), STOP.	P1AX, P1BX
	If pumps move (indicating leakage) STOP.	F7AX, F7BX
	Turn on A blue light, open A dosing valve, user opens sampling valve.	--
	Close A dosing valve on upstroke; check for no movement.	DFAX
	Close A dose valve on down stroke; check for no movement.	DGAX
	Open A dose valve and dispense total of 750 ml material, close valve, turn off blue light.	--
	Repeat for B side.	DFBX, DGBX
	If both pumps pass pump test, display shows two beakers of 750ml each.	--

Mode	Control Logic	Alarms
Batch Dispense Test	User selects total volume desired.	--
	Open A dosing valve, turn on blue light, user opens sampling valve, turn off blue light when complete.	--
	Open B dosing valve, turn on blue light, user opens sampling valve, turn off blue light when complete.	--
	Display shows volume of A and B components at end of batch dispense test.	--
Valve Test	If fluid pressure is not 1000 psi (7 MPa, 70 bar), STOP.	P1AX, P1BX
	Check for no movement of pumps (stall within 10 seconds).	F7AX, F7BX



### Alarm And Advisory Code Key

Use the following table as a quick guide to determine alarm codes.

EVENT		MODE		LOCATION		ZONE			
A	Current	1	Low Alarm	A	Material A	1	Tank A		
F	Flow	2	Low Deviation	B	Material B	2	Tank B		
L	Tank Level	3	High Deviation	C	Controller	A	Heater A		
P	Pressure	4	High Alarm	D	Output Discharge	B	Heater B		
R	Ratio	5	Calibration	F	Input Feed	C	Level Sensor A		
T	Temperature	6	Sensor Failure	M	Pneumatic Supply	D	Level Sensor B		
V	Voltage	7	Unexpected Non-Zero Value	P	Pneumatic Supply	E	Hose		
		8	Unexpected Zero Value			R	Recirculation	H	Heater Hose
		9	Unstable			J	Linear Sensor		
C	Communication	A	Loss			K	Reed Switch		
D	Pump	A	Runaway			P	Display		
		D	Cavitation			X	System		
		E	Time-out						
		F	Stall Up						
		G	Stall Down						
		J	Linear Sensor						
		K	Reed Switch						
M	Maintenance	A	Pump						
		E	Valve						
		G	Filter						
Q	Proportioning	D	Overdose						
		P	Potlife						
		T	Dosing Time						

## Accessories and Kits

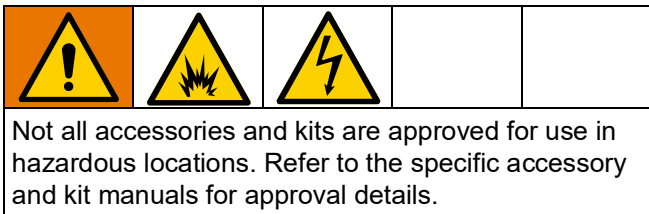

### 20-Gallon Hopper Kit, 255963

One complete double-wall 20-gallon hopper. See your hopper manual for more information.

### Hopper Heater Kit (240V), 256257

For heating fluid in a 20-gallon hopper. See your hopper manual for more information.

### Universal Hopper Fluid Inlet Kit, 256170

For connecting any of the four lower models included with XM sprayer to a 20-gallon hopper. See your hopper manual for more information.

### Universal Hopper Mounting Kit, 256259

For mounting a 20-gallon hopper to the side or back of an XM sprayer. See your hopper manual for more information.

### Twistork® Agitator Kit, 256274

For mixing viscous materials held within a 20-gallon hopper. See your feed pump and agitator manual for more information.

### T2 Feed Pump Kit, 256275

For supplying viscous material from a 20-gallon hopper to an XM sprayer. See your feed pump and agitator manual for more information.

### 5:1 Feed Pump Kit, 256276

For supplying viscous materials from a 20-gallon hopper to an XM sprayer. See your feed pump and agitator manual for more information.

### 7-Gallon Hopper and Bracket Kit, 256260 (Green) 24N011 (Blue)

One 7-gallon hopper and mounting brackets. Mounts to the side or back of an XM sprayer. See your hopper kit manual for more information.

### 2:1 Drum Feed Kit, 256232

One T2 pump feed kit and one Twistork agitator kit for mixing and supplying viscous materials from a with 55-gallon drum to an XM sprayer. See your feed pump and agitator manual for more information.

### 5:1 Drum Feed Kit, 256255

One 5:1 pump feed kit and one Twistork agitator kit for mixing and supplying viscous materials from a with 55-gallon drum to an XM sprayer. See your feed pump and agitator manual for more information.

### Hopper/Hose Heat Circulation Kit, 256273

For circulating heated water through 20-gallon hoppers, heated hose, and Viscon HP heater. See your hopper or hose heat circulation kit manual for more information.

### Desiccant Dryer Kit, 256512

For use with 20-gallon hoppers. See desiccant kit manual for more information.

### Caster Kit, 256262

For mounting casters on XM sprayer frame. See your caster kit manual for more information.

### Hose Rack Kit, 256263

For mounting to side, front, or back of XM sprayer frame. See your hose rack kit manual for more information.

### Lower Strainer and Valve Kit, 256653

For straining material from a feed pump to an XM sprayer fluid inlet. See lower strainer and valve kit manual for more information.

### **Electric Heated Hose Power Supply Kit, 256876**

For monitoring and controlling fluid temperature in low-voltage heated hoses. See your electric heated hose power supply kit manual for more information.

### **5000 psi Two-Component Main Heated Hose Set Kit**

Electric heated hose set for adding additional sections.

<b>Part</b>	<b>Description</b>
248907	Heated hose set; 1/4 in. ID x 3/8 in. ID; 50 ft.
248908	Heated hose set; 3/8 in. ID x 3/8 in. ID; 50 ft.

### **Xtreme Pump Wetcup Wrench, 15T258**

### **Xtreme Pump Filter Wrench, 16G819**

### **10:1 Drum Feed Kit, 256433**

For supplying highly viscous material from a 55-gallon drum to an XM sprayer. See your feed pump and agitator kit manual for more information.

### **Shutoff/Check Valve Kit, 255278**

For replacing shutoff valve or check valve. See your high flow severe duty shutoff check valve manual for more information.

### **Alternator Conversion Kit, 256991**

For converting an XM sprayer from wall power supply to intrinsically safe alternator power supply. See your alternator conversion kit manual for more information.

### **Mix Manifold Kit, 255684**

See your mix manifold kit manual for more information.

### **Remote Mix Manifold and Carriage Kit, 256980**

For converting to a remote mix manifold kit with a protective guard. See your mix manifold kit manual for more information.

### **Restrictor Valve Kit, 24F284**

For B dosing outlet on remote mix manifold machines. Use to convert early XM machines without the valve on the B outlet.

### **Restrictor Valve Wrench, 126786**

For adjusting restrictor valve. See page 43.

### **Remote Recirculation Mix Manifold Kit, 273185**

# Appendix A

## User Interface Display

The user interface display is divided into three main functions: Setup, Command, and Automatic.

### Setup Mode Screens (key to right)

The setup functions enable users to:

- change between volume and weight ratio
- set desired mix ratio by volume or weight
- set weight ratio and tolerance for ratio checks
- configure system settings
- set potlife parameters
- enable/disable functions, displays, and display components
- set which USB logs to download
- schedule maintenance parameters for alarms and advisories
- set pressure and temperature limits
- set tank “fill” and “full” levels

Some setup functions must be enabled from the Enable Setup screens before users can change or set configurations. Follow **Enable Setup Screens**, page 82, for instructions.

### Operator Command Mode Screens (key to left or removed)

Use these screens to:

- run pumps, including flush, circulate, and prime procedures
- park metering pumps so pump rods are down when not in use
- mix and spray
- view mix ratio
- run pump tests/calibrate weight mode
- run batch dispense ratio tests
- run valve leak checks
- view dispense totals
- view alarms
- diagnose alarms
- clear alarms

### Automatically Displayed Screens

These screens are shown when

- The potlife timer alarms to notify the user that material is about to cure in the system.
- download USB logs.

## Change a Setting

All settings are changed in the same manner:

1. Navigate to the desired screen. Follow **Operator Command Mode Screens**, or **Setup Mode Screens**.
2. Once in the desired screen, use the arrow keys to navigate to the item that you wish to change.
3. Press enter to enter editing mode.
4. Use the arrow keys to change the selection or value.
5. Press enter again to save the change or press  to cancel the change.

# Setup Mode Screens

Setup mode screens are divided into five major sections: home, limits, maintenance, enable, and system. The following figure demonstrates the flow of the Setup mode screens beginning with the Home screen.

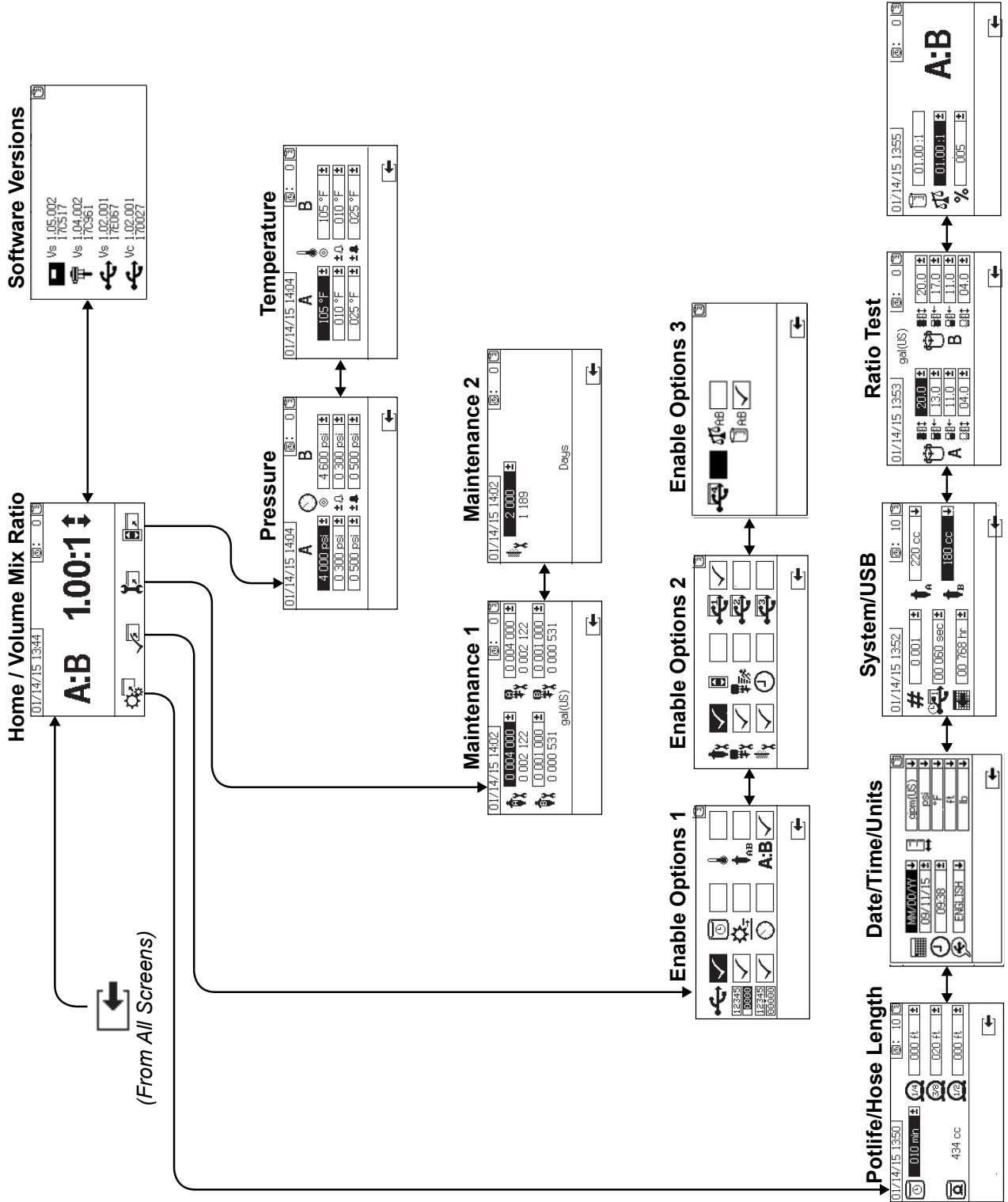

## Home Setup Screens (Key Switch On)

### Home

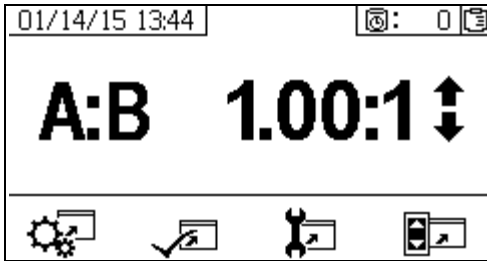

Home is the first screen that displays in Setup mode. It shows the current metering pump ratio and enables users to change the mix ratio and access the following screens: system setup, enable/disable functions, maintenance setup, and limits. Refer to the following table for more details.

Icon	Function
	Increase or decrease mix ratio. Press  and  to change the mix ratio.
	Navigate to jump to system setup screens.
	Navigate to enable/disable options screens.
	Navigate to maintenance setup screens.
	Navigate to pressure and temperature limits setup screens.

### .Software Versions

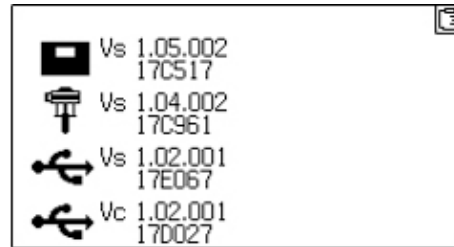















This screen displays the versions and part number of the system components. Refer to the following table for details. To access this screen, press from the Home Setup screen.

Icon	Function
	Display module version (Vs) and part number
	Advanced fluid control module version (Vs) and part number
	USB version (Vs) and part number USB Configuration (Vc) and part number

## System Setup Screens

System Setup enables users to configure system settings for fluid control and operator interaction. Refer to the following table for details.

Some system settings must be enabled from the Enable Setup screens before users can change or set configurations. Follow **Enable Setup Screens**, page 82, for instructions.

Icon	Function
	Set number of minutes before mixed material will set in hose. Resets after material volume set by user is passed through hose.
	Indicates total hose volume. Always displayed in cc units.
	Set length of hose after mix manifold. Used to indicated total hose volume.
	Set calendar date and format.
	Set time.
	Set USB language.
	Set units of measurement desired for display, such as fluid and temperature.
	Set sprayer number if using more than one sprayer.
	Set how often data will record to USB ratio and spray logs.
	Set number of hours of recorded data to download to USB flash drive.
	Set the A and B side metering pump sizes.
	Volume ratio reference
	Weight ratio reference
	Ratio Pass Tolerance

## Potlife/Hose Length

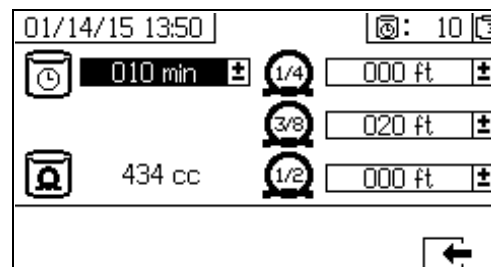

This screen enables users to set the potlife timer, and length of each mixed material hose specific to the system. The total mixed material volume is then calculated and displayed on the page. The potlife time displays in the upper right corner.

When the fluid flow stops the displayed potlife time counts down in one minute intervals. The timer automatically resets when the calculated mixed fluid volume is dispensed.

## Date/Time/Units

Use this screen to set day, time, and units that will be displayed on each screen. The selected language is used in each USB log. The following USB languages are supported: English, French, German, Spanish, Russian, Italian, Chinese, Japanese, Korean, Norwegian, and Polish.

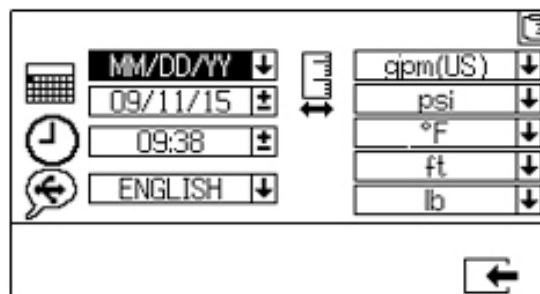

### System Number and USB Settings

This screen enables users to set the sprayer number if using more than one sprayer. It also enables users to configure the number of hours downloaded to external USB flash drive and how often the data will record. See **Set System Settings (Optional)**, page 34, for instructions.

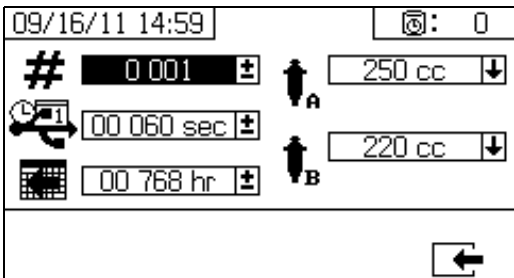

### Pump Configuration

Users can change the pump size that is specific to the system if the pump box is selected on **Enable Setup 1**, page 82.

**NOTICE**

Changing the pump size settings may cause the system to spray off ratio.

#### Set Pump Sizes

To change the pump size, press and to select the field. Press to open the drop down field.

Press and to select the preferred pump size.

Press again to save the change.

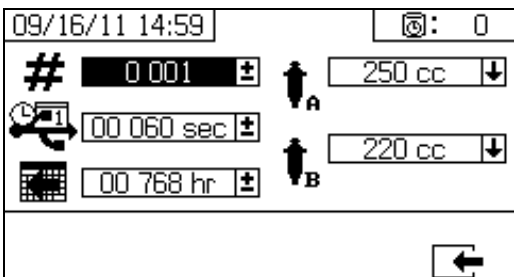

#### Set Custom Pump Sizes

Custom pump sizes can also be entered. In the pump size box describes above, select CUSTOM as the pump

size. A new pump volume entry field will appear as

shown below. Press and to select the volume entry field. Press to begin editing.

Enter the pump size in cubic centimeters (cc). To enter a number press and to change numbers. Press and to move between digits.

Press to exit the field.

The entered pump volume will be saved by the system, but it will only be used when CUSTOM is selected. Pump A and pump B volume are entered separately.

The standard pump sizes of 290 cc, 250 cc, and 220 cc have maximum pressure limits of 5600 psi (38.6 MPa, 386 bar), 5600 psi (38.6 MPa, 386 bar), and 6000 psi (41.4 MPa, 414 bar), respectively. Other pump sizes and the custom pump size (for any volume entered) have a maximum pressure limit of 7000 psi (48.3 MPa, 483 bar).

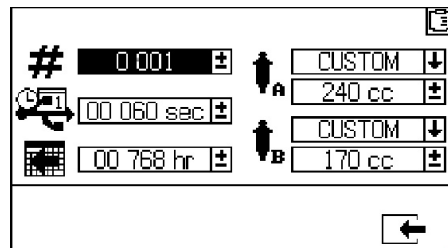

### Ratio Test

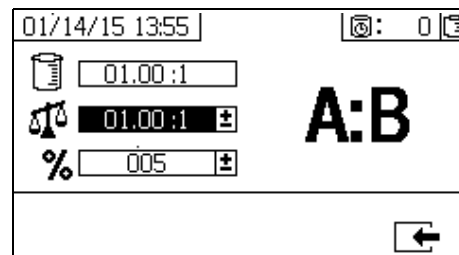

For Ratio by Volume Mode, use this screen to set the ratio by weight (middle number), and the ratio tolerance (bottom number). The values determine whether the ratio test passes. The ratio by volume (top number) is displayed but cannot be changed on this screen. Follow



**Home** screen, on page 78, to change the ratio by volume.

For Ratio by Weight Mode, use this screen to set the ratio by weight tolerance (bottom number). The ratio by weight (top number) is displayed but cannot be changed

on this screen. Follow **Home** screen, on page 78, to change the ratio by weight.

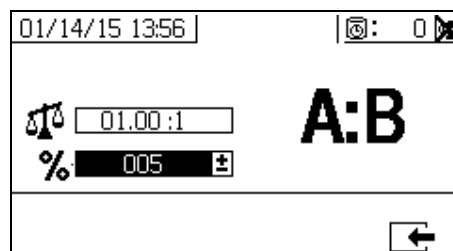







## Enable Setup Screens









Enable Setup allows users to enable and disable functionalities, screens, and USB download log files. Checked boxes indicate the function, screen, or log file is active. Refer to the following table for details.









To enable and disable functionalities, screen, and USB

log files, press  from the Home Setup screen.

Once in the Enable Setup screen, press  and  to scroll through each subscreen. Press  and  to scroll through each field within the subscreens, and press  to enable or disable each.

Press  to return to the Home Setup screen

Icon	Function
	USB data download function. Disable this function to prevent operators from changing USB settings. Even if this function is disabled, selected USB logs will still be downloaded.
	Enable or disable Totalizer screens.
	Enable or disable batch Totalizer clear function.
	Display potlife timer on all screens. Enable or disable potlife timer setup screen.
	Display flow rates on run screens
	Display A and B pressures on run screens.
	Display A and B temperatures on run screens.
	Enable or disable ability to change pump size in system setup screens.
<b>A:B</b>	Enable or disable ratio screen. If enabled, ratio screen will automatically display after sprayer runs for 10 seconds.
	Enable or disable pump maintenance setup screens.

Icon	Function
	Enable or disable dosing valve maintenance setup screen.
	Enable or disable incoming air filter maintenance setup screen.
	Enable or disable limits (pressure and temperature) screens.
	Fast dosing function. Enable function to minimize B side dose size and increase dosing rate. See table below.  Use this function with short integration hose. The system will attempt to hold the dosing sizes below the advisory level.
	Display time on all screens.
	Enable or disable USB log files (1-3) to download.
	Selects system ratio by volume  or ratio by weight  mode. Only one of these modes can be enabled at one time.

### Fast Dosing Function

Fast Dosing	Advisory QTAE	Alarm QDAE
on	20 cc	30 cc
off	35 cc	45 cc

### Enable Setup 1

(Shown with factory default settings.)

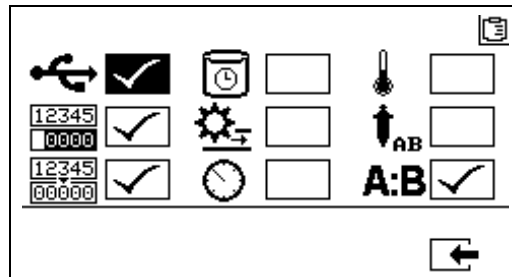

### Enable Setup 2

(Shown with factory default settings.)

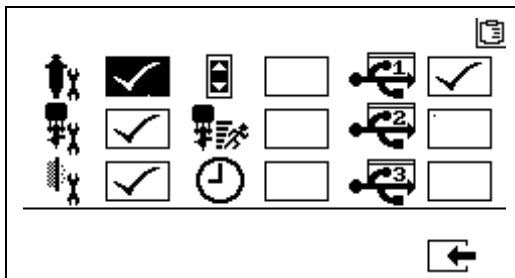

### Enable Setup Screen 3

(Shown with factory default settings.)

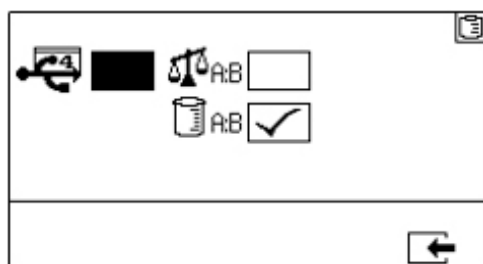

**NOTE:** The machine will be shipped in Volume Mode.

## Maintenance Setup Screens

The maintenance setup 1 screen enables users to set maintenance setpoint amounts for pumps and dosing valves. The maintenance setup 2 screen enables users to schedule the number of days between changing the main incoming air filter before a reminder advisory will sound.

The number displayed below each selectable field indicates the amount of material dispensed, counting up to the setpoint requiring maintenance.

Icon	Function
	Set amount of material moved through pump that will result in a maintenance warning.
	Set amount of material moved through dosing valve that will result in a maintenance warning.
	Set number of days between changing the main incoming air filter before a reminder advisory is issued.

### Maintenance Setup 1

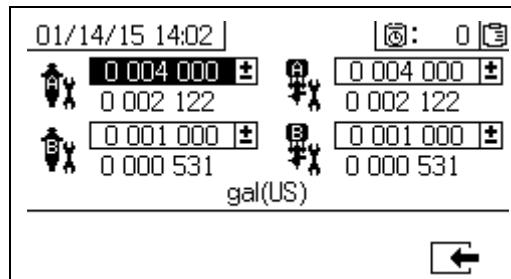

### Maintenance Setup 2

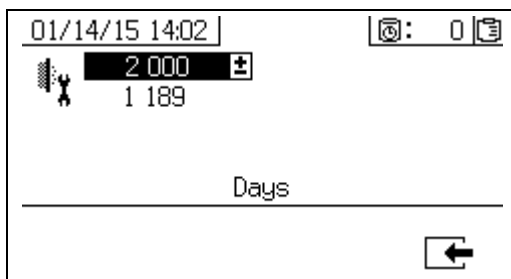





## User Limits Setup Screens

Use these screens to set and adjust pressure and temperature limits for both metering pumps, including limits that will issue advisories and alarms. Refer to the following table for details.

The allowable range for the temperature setpoint is 34° - 160°F (1° - 71°C). If the temperature or pressure setpoint is zero, pressure limits and alarms are disabled.

NOTE: The B metering pump pressure always runs 10-20% higher than the A metering pump pressure.

Icon	Function
	Set and adjust pressure limits for both metering pumps during spray mode.
	Set and adjust high and low temperature limits for both fluid heaters during spray mode.
	Set target pressure or temperature.
	Set and adjust limits above or below target value that if exceeded will issue an advisory. Used with pressure and temperature limits.
	Set and adjust limits above and below target value that if exceeded will issue a alarm. Used with pressure and temperature limits.

### Process Pressure Limits (for spray mode)

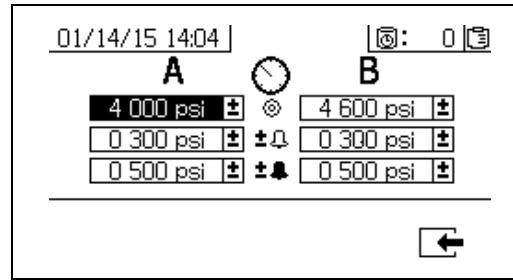

### Process Temperature Limits (for spray mode)

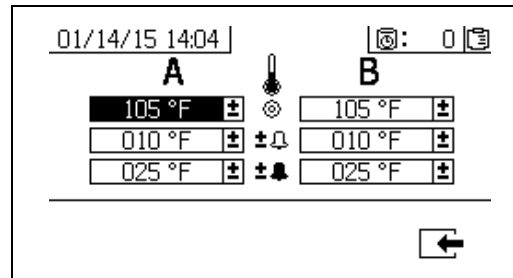

# Operator Command Mode Screens

Command mode screens are divided into three major sections: run (fluid control), test, and alarm control. The following figure demonstrates the flow of the Command mode screens beginning with the run (fluid control) screens.

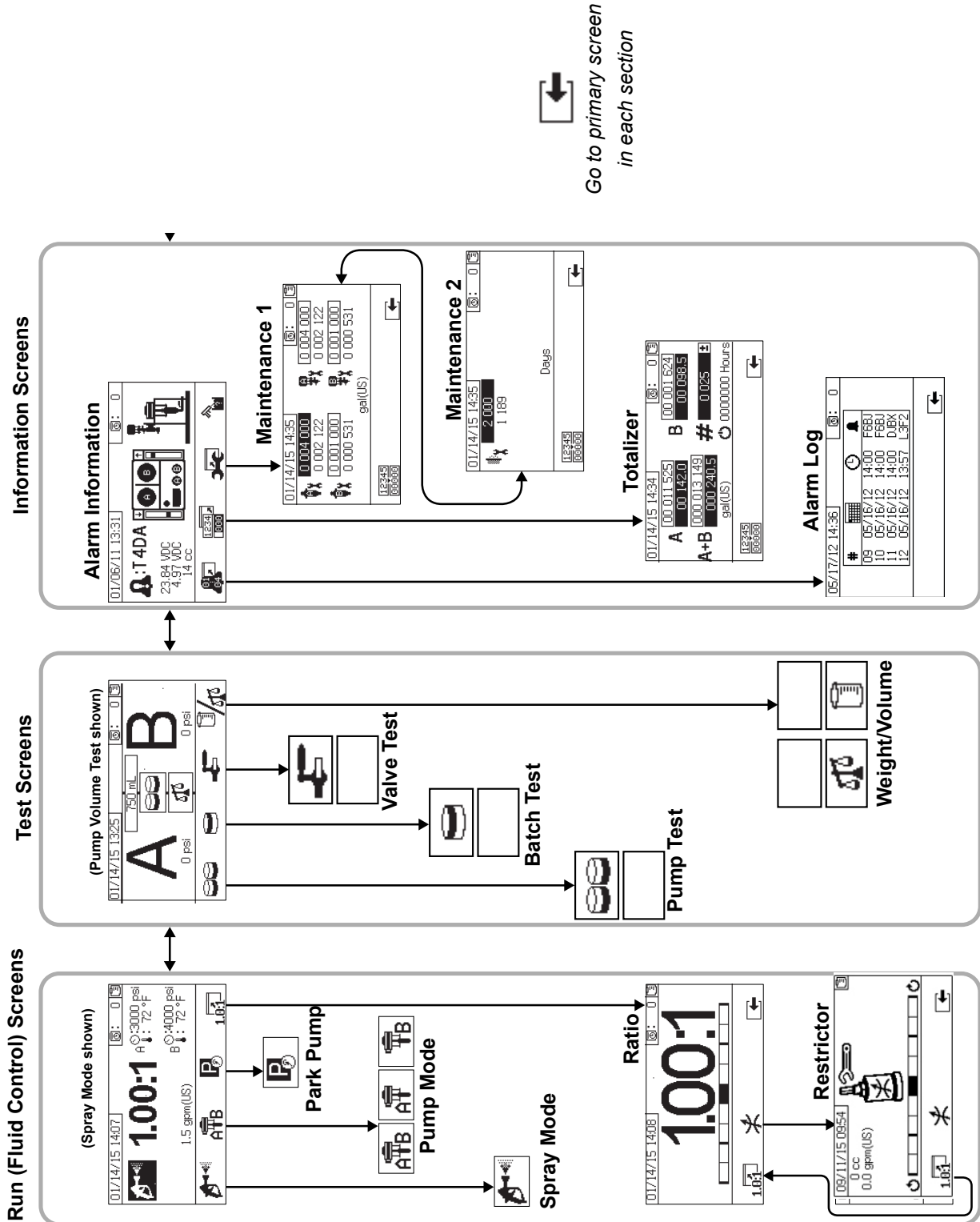







## Run (Fluid Control) Screens

Run (fluid control) is the first screen displayed at power on. It enables users to spray material, and operate and park pumps. Run consists of two screens: power on/enter and ratio mode.

The power on/enter screen cycles through power on mode, spray mode, and pump mode. It always displays the current ratio setpoint, and may also display: pressure, temperature and flow rate if these functions are selected.

The ratio screen displays the current ratio and monitors the B side restriction adjustment.

Icon	Function
	<i>Spray:</i> proportion and spray material.
	<i>Icon at bottom of screen:</i> Select which metering pumps are active. Press repeatedly to cycle through metering pump A, metering pump B, and both metering pumps. <i>Icon in rectangle:</i> Operate both metering pumps.
	Operate the A metering pump only (priming, flushing).
	Operate the B metering pump only (priming, flushing).
	<i>Park Metering Pumps:</i> run metering pumps to bottom of the stroke.
	<i>Ratio:</i> jump to ratio screen.

### Power On/Enter Mode

Power On/Enter Mode is the default screen when users enter Fluid Control.

This screen remains blank until a mode is selected.

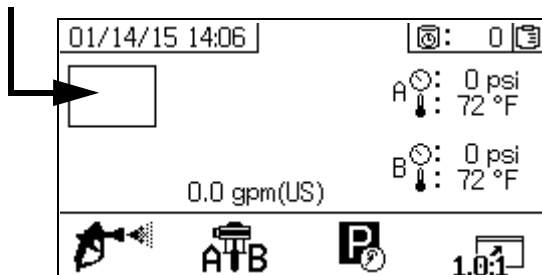

### Spray Mode

Users must be in this mode to spray or proportion material. Press the button below the spray icon to enter this mode.

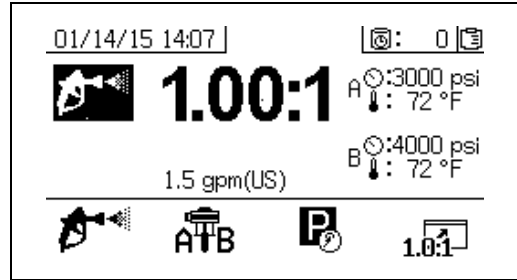

### Pump Mode

Users must be in this mode to operate pumps for priming or flushing. Press the button below the pump icon to enter this mode. Continue pressing the pump icon button to cycle through pump A, pump B, and both pumps.

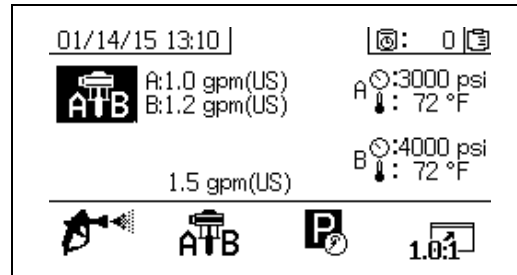

### Park Mode

Users must be in this mode to park fluid rod pumps at the bottom of the stroke. Press the button below the park icon to enter this mode.

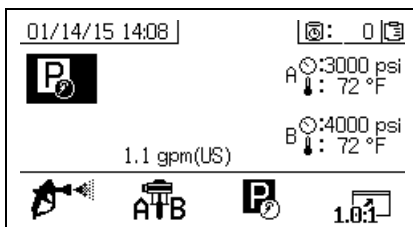

### Ratio Mode

Displays the current ratio or the restrictor screen. To access this screen, press . The bar graph indicates whether the B restriction adjustment should be turned clockwise or counter clockwise. See **Adjust B Machine Outlet Restriction**, page 43.

The ratio displayed is the weight ratio if the machine is in Ratio by Weight Mode. The ratio displayed is the volume ratio if the machine is in Ratio by Ratio Mode.

If the **A:B** field is enabled on the Enable Setup screen, the Spray Mode screen will be replaced by the bar graph screen after 10 seconds of spray time. Press to return to the Spray Mode screen.

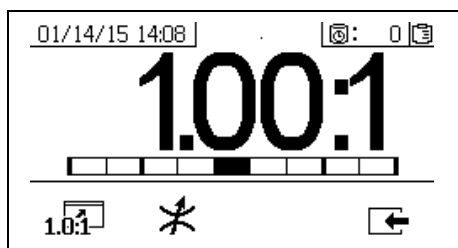

### Restrictor Screen

Icon	Function
	<i>Display Ratio:</i> show the accuracy of the fluid mix ratio.
	<i>Display Restrictor Adjust:</i> Adjust the restrictor to optimize the mix ratio. <ul style="list-style-type: none"> <li>• At the maximum fluid flow, the bar should be in the center.</li> <li>• At less than maximum flow, the bar should be on the right side.</li> </ul>

### Test Screens

Test screens enable users to run batch dispense tests, pump tests, and down stream valve leak tests.

Icon	Function
	<i>Pump Test:</i> dispenses 750cc of each A and B; verifies pump selection, operation, and metering. In system weight mode, this calibrates the system by entering weights.
	<i>Batch Dispense:</i> dispenses proportioned amounts of A and B with a selectable total.
	<i>Down Stream Valve Leak Test:</i> test if valves after the dosing valves hold pressure.
	<i>Test Mode Selection:</i> Switch between volume and weight test mode.

### Pump Test/Calibrate

This screen enables users to dispense a fixed 750 ml volume of material from each pump. When the pump is active it flashes in black on the screen. When the pump completes dispensing it displays gray on the screen.

If the system ratio mode is by volume, pressing will allow the test to be run either by measuring volumes or weights. If system ratio mode is by weight, then the displaced materials must be measured by weight.

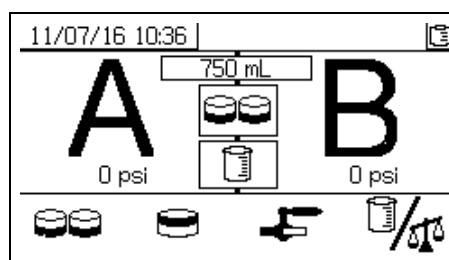

### Confirm Pump and Metering Test

This screen displays when the pump test completes without error. There are three variations that affect how the screen is used.

**Ratio by Volume Mode - Test by Volume**

Enter the volumes of each dispensed material in the respective input boxes on this screen. If the calculated ratio is within the ratio tolerance set on the Setup Ratio Test screen, a check will appear in the box. The results are entered into the USB logs.

The target ratio by volume for this test is set on the Setup Home screen on page 78. The tolerance is set on the Setup Ratio Test screen on page 80.

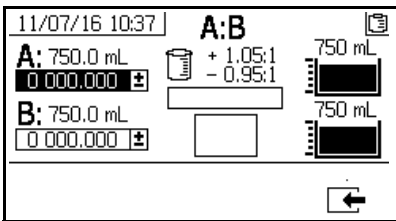

**System Ratio Mode by Volume - Test by Volume**

**Ratio by Volume Mode - Test by Weight**

Enter the net weights of each dispensed material in the respective input boxes on this screen. If they are within the ratio tolerance set on the Setup Mode Ratio Test screen, a check will appear in the box. The results are entered into the USB logs.

The target ratio by weight for this test and tolerance is set on the Setup Ratio Test screen on page 80.

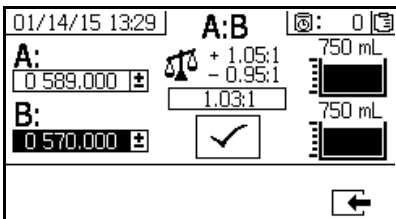

**System Ratio Mode by Volume - Test by Weight**

**Ratio by Weight Mode**

This screen displays two boxes where the A and B sample weights are entered to calibrate the machine to run in Ratio by Weight Mode. The weights must be entered in grams.

The target ratio by weight for this test is set on the Setup Home screen on page 78. The tolerance is set on the Setup Ratio Test screen on page 80.

Once entered, a check will appear in the box. There will still be an X through the scale in the upper right corner until a Ratio Test is performed successfully.

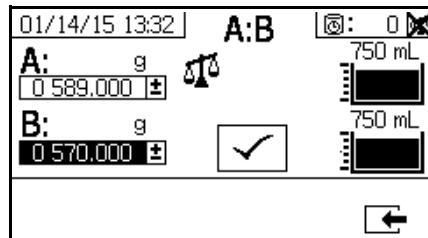

**System Ratio Mode by Weight**



### Batch Dispense or Ratio Test

This screen enables users to dispense a selected total volume of material on ratio. For example, 1000 ml at 4:1 = 800 ml of A + 200 ml of B. The total batch volume can be selected from the drop down menu.

When the pump is active it flashes in black on the screen. When the pump completes dispensing it displays in gray on the screen.

If the system ratio mode is by volume, pressing  will allow the test to be run either by measuring volumes or weights. If system ratio mode is by weight, then the displaced materials must be measured by weight.

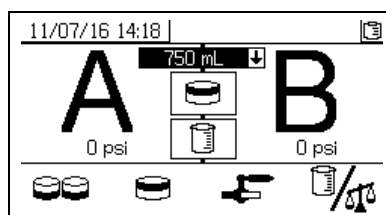

### Confirm Batch Dispense Test

This screen displays when the batch dispense test completes without error. This screen displays the selected ratio between the pumps and the volume of material dispensed from each pump. The gray at the bottom of the beaker represents the volume of material dispensed by pump A. The black at the top of the beaker represents the volume of material dispensed by pump B.

There are three variations that affect how the screen is used:

#### Ratio by Volume Mode - Test by Volume

Enter the volumes of each dispensed material in the respective input boxes on this screen. If the calculated ratio is within the ratio tolerance set on the Setup Ratio Test screen, a check will appear in the box. The results are entered into the USB logs.

The target ratio by volume for this test is set on the Setup Home screen on page 78. The tolerance is set on the Setup Ratio screen on page 80.

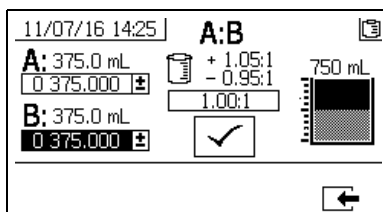

**System Ratio Mode by Volume - Test by Volume**

#### Ratio by Volume Mode - Test by Weight

Enter the weights of each dispensed material in the respective input boxes on this screen. If calculated ratio is within the ratio tolerance set on the Setup Ratio Test screen, a check will appear in the box. The results are entered into the USB logs.

The target ratio by weight for this test and tolerance is set on the Setup Ratio Test screen on page 80.

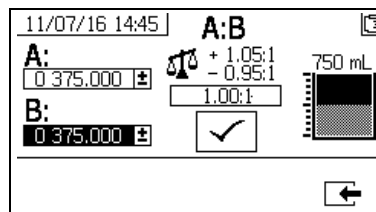

**System Ratio Mode by Volume - Test by Weight**

#### Ratio by Weight Mode

Enter the weights of each dispensed material in the respective input boxes on this screen. The weights must be entered in grams. If calculated ratio is within the ratio tolerance set on the Setup Ratio Test screen, a check will appear in the box. The results are entered into the USB logs.

The target ratio by weight for this test is set on the Setup Home screen on page 78. The tolerance is set on the Setup Ratio Test screen on page 80

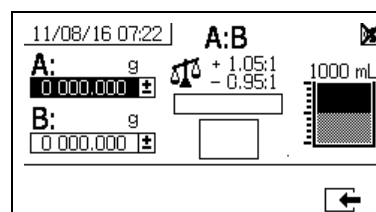

**System Ratio Mode by Weight**

### Down Stream Valve Leak Test

This screen enables users to test for closed or worn valves down stream of the A and B dosing control valves. It can be used to test the mix manifold shutoff/check valves or any remote circulation valves.

While running the test, if there is continuous pump movement on the A or B side, an error will be issued. The error indicates a leak in the valve.

There is no confirmation screen for this test. However, if the down stream valve leak test fails, an warning is issued to indicate the cause of the failure.

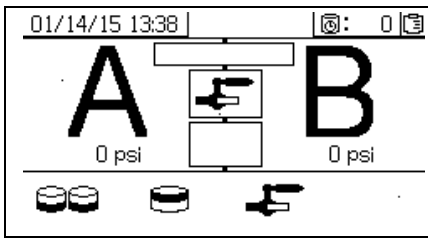

### Confirm Valve Leak Test

This screen displays when the valve leak test completes and indicates whether the test was successful.

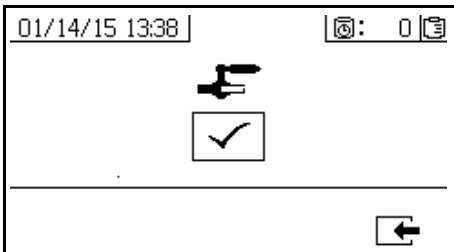

### Information Screens

Use this screen to view diagnostic information, alarm logs, and pump batch and grand totals. These screens also enable users to view maintenance information for pump and check valves, including the maintenance schedule.

If the potlife timer is enabled the Flush Confirm icon,



displays.

### Alarm

The Alarm screen displays the specific alarm code. There are two levels of error codes: alarms and advisories. A solid bell icon with an exclamation point and three audible alerts indicate a alarm. And an outlined hollow bell icon and a single audible alert indicate an advisory.

Additionally, this screen displays the location of the error with the top view and side view of the system. Refer to the following table and subsections for more details.

The first number below the alarm code is the main power supply voltage used by the electronic modules. The voltage should read between 23 VDC - 25 VDC for non-hazardous location systems, and 10-14 VDC for the hazardous location systems.

The second number below the alarm code is the power supply voltage used by the system sensors. This voltage should read between 4.9-5.1 VDC.

The third number below the alarm code is the A side pump dosing size. This value is displayed in volumes of cubic centimeters (cc) and is the volume pumped on the A side when the B side dosing valve is off. Optimizing the restriction of the system will keep this value small and ensure material is mixed well.

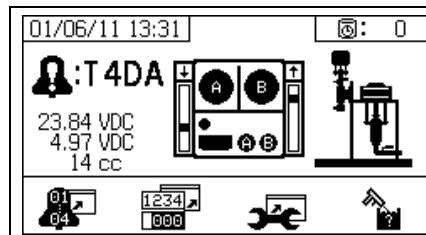

Icon	Function
	Go to Alarm log. Use up and down arrows to scroll through list of the past 16 errors.
	Go to Totalizer screen. Allows users to view the grand and batch totals for each pump and both pumps combined.
	Go to maintenance screen. Allows user to view maintenance information but not make changes. Follow <b>Maintenance Setup 2</b> , page 83.
	Flush confirm. Use when the potlife timer is enabled. Press button to confirm flush before a potlife advisory is issued.
	Amount of material moved through pump that will result in a maintenance warning.
	Amount of material moved through dosing valve that will result in a maintenance warning.
	Number of days between maintenance cycles that will result in a reminder advisory.
	Clear batch Totalizers or maintenance counters.

### Alarm Log

View details regarding alarms received, including the date, time, and alarm code for the last 16 alarms. Up to four pages of alarms are available.

Press to access the alarm log. The press and to scroll through each page of alarms.

05/17/12 14:36		🔊: 0	
#	📅	🕒	🔔
09	05/16/12	14:00	F6BJ
10	05/16/12	14:00	F6BJ
11	05/16/12	14:00	DJBX
12	05/16/12	13:57	L3F2

### Totalizers and Job Number

Use this screen to view the grand and batch totals for each pump and both pumps combined. The units of measurement are displayed on the bottom of the screen and displayed in the units of measurement selected during setup.

Grand total is the amount of material the system has dispensed during its lifetime. Batch total is the amount of material dispensed since the last user reset.

A job number can be entered at the beginning of each spray job. This helps to organize the USB spray log.

### Clear Batch Totalizer







To clear the batch Totalizer values for A, B, and A+B,

press to set all values to zero.

01/14/15 14:34		🔊: 0	
A	00 011 525	B	00 001 624
	00 142.0		00 098.5
A+B	000 013 149	#	0 025
	000 240.5		🕒 0000000 Hours
gal(US)			

Icon	Function
	Displays batch total and grand total for pump A. The grand total is displayed at the top, and the batch total is displayed at the bottom.
	Displays batch total and grand total for pump B. The grand total is displayed at the top, and the batch total is displayed at the bottom.
	Displays batch total and grand total for both pumps combined. The grand total is displayed at the top, and the batch total is displayed at the bottom.
	Displays job number for each spray period.
	Number of hours system has been running

### Change Job Number

1. Press  to highlight the first digit. Press  and  to change the number and  and  to move to the next digit. Press  to save the number or  to cancel.

### Maintenance 1 Screen

View setpoints for the amount of material that needs to move through both pumps and dosing valves that will result in a maintenance warning.

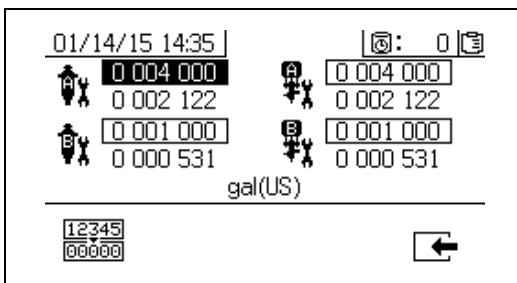



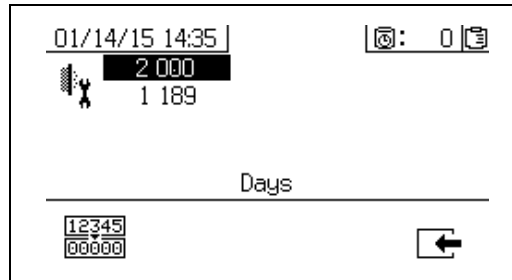

### Maintenance 2 Screen

View number of days between changing the main incoming air filter before a reminder advisory is issued.







### Reset Maintenance Counter

1. Press  and  to scroll through and select the maintenance field to reset.
2. Press   to reset the maintenance counter to zero.

## Automatically Displayed Screens

### Potlife Screen

The potlife screen automatically displays when a potlife advisory occurs. The screen automatically closes when the advisory end or the user presses the flush confirm button. Refer to the following table for more details.

Icon	Function
	Advisory has been issued.
	Potlife timer is enabled.
	Time after potlife expires. Starts at 0.00 and counts down in negative one minute intervals.
	Press to mute advisory buzzer.
	Press to confirm that mixed hose has been flushed. Resets potlife timer.









### USB Screen

The USB screen automatically displays and the selected log(s) automatically starts downloading when the USB flash drive is inserted into the USB port (DR).

Inserting the USB flash drive while the sprayer is running automatically stops sprayer operation. Removing the USB flash drive automatically closes the USB screen.

The log selected for current download is displayed in the single box next to the USB icon. The other available logs are displayed in the boxes on the right side of the screen. Refer to the following table for more details.

Icon	Function
	Flashes while data download is in process.
	Check mark appears after download completes. Indicates download was successful. If download was not successful,  appears.
	Displays total memory to download and remaining memory left to download.
	Displays time remaining for log download to complete.
	Press to cancel download. If download is canceled, remove USB flash drive.
	Indicates which log(s) is being downloaded.

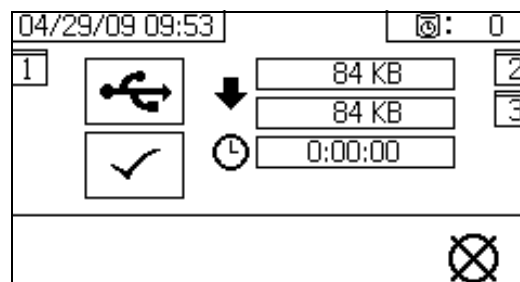

### Recommended USB Flash Drive

Use the USB flash drive (17L724) included with the XM sprayer for data download.

# Appendix B

## Metering Diagrams

### Metering Diagram without Remote Mix Manifold

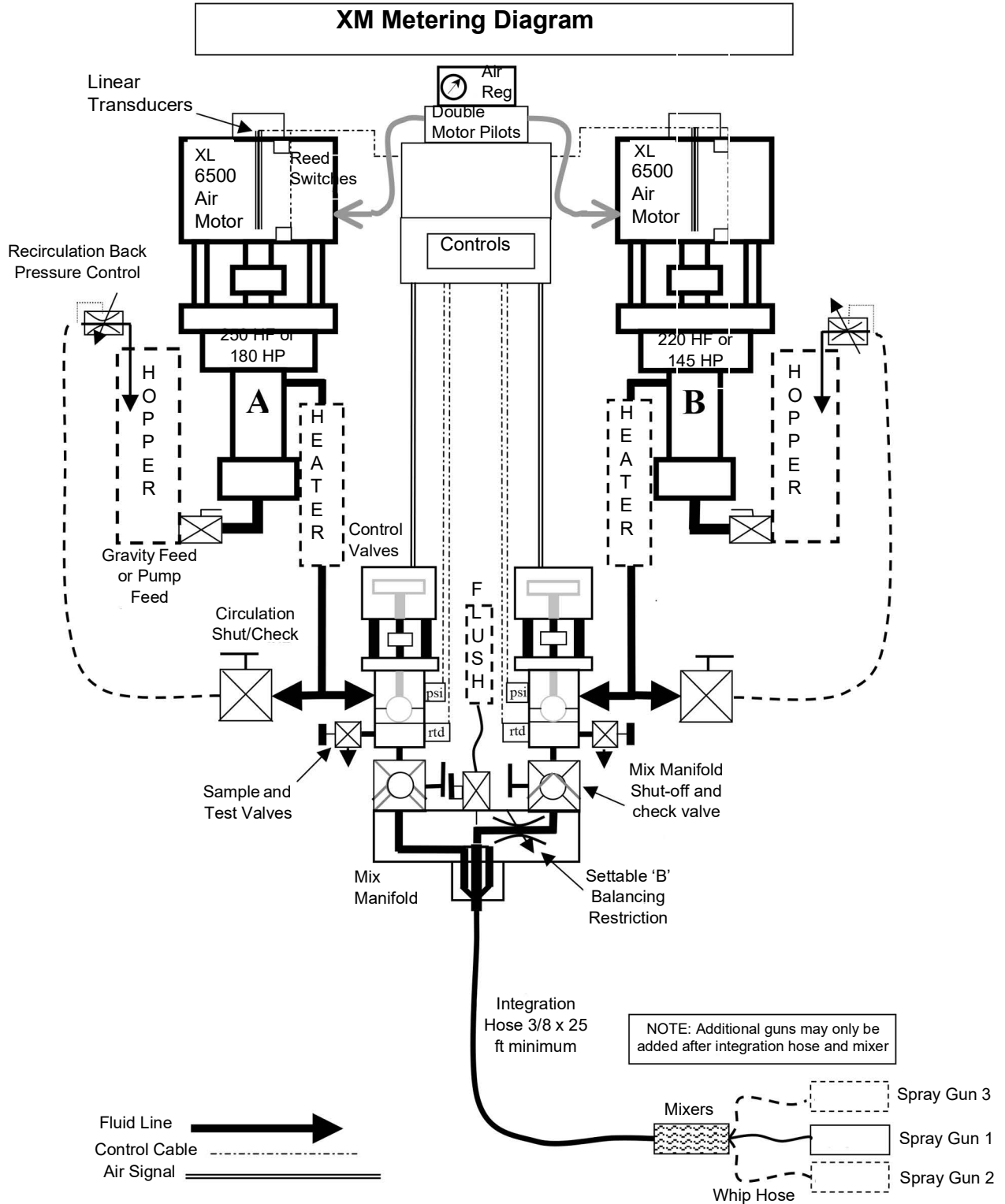

### Metering Diagram with Remote Mix Manifold

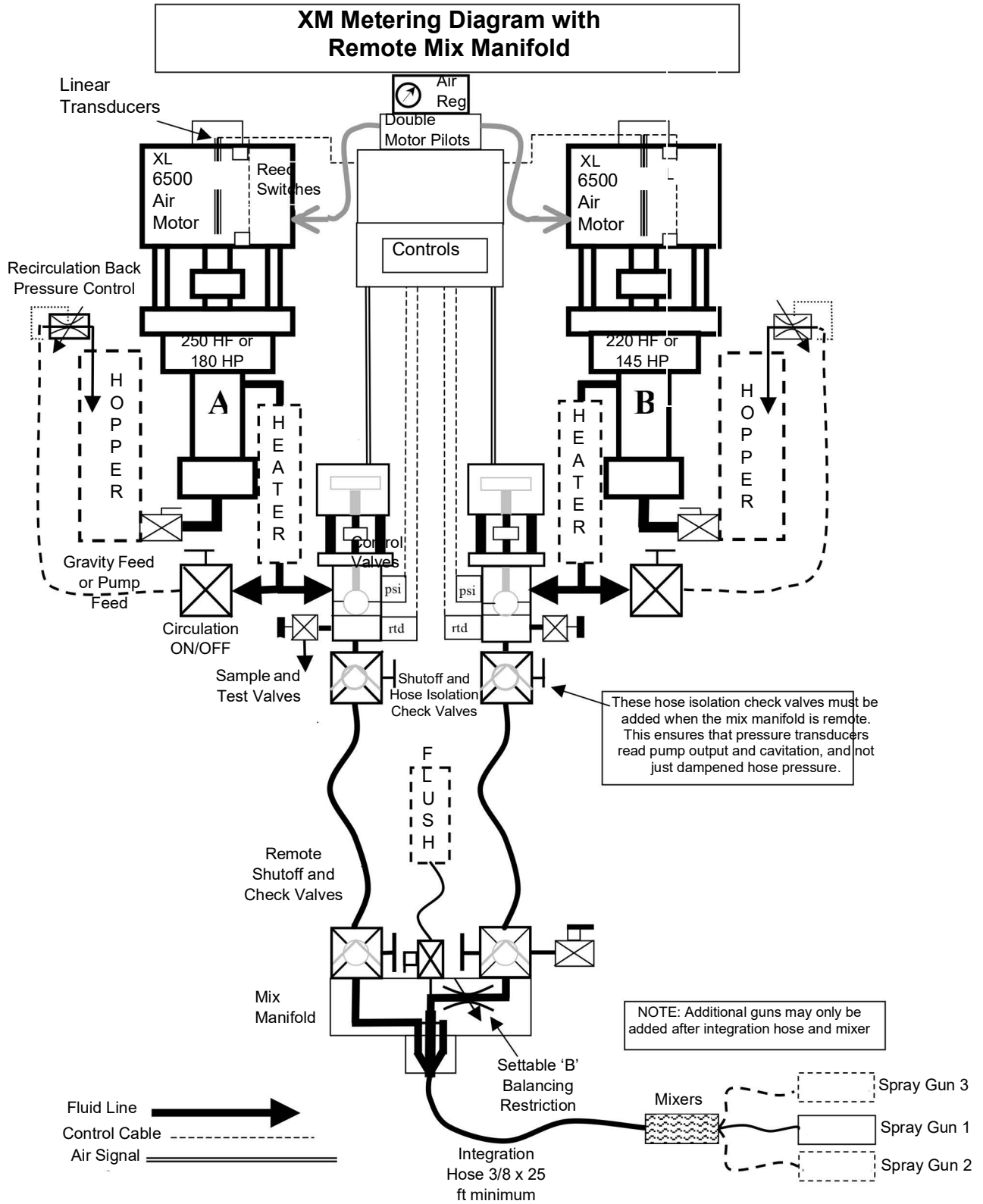

# Appendix C

## Power Cord Guidelines

Use the guidelines listed in the following table to determine the power cord needed for your specific system.

Table 6: Base System Maximum Current Draw		
	XM_L00	XM_N00
<b>Power Supply</b>	Wall	Alternator
<b>Configuration Options:</b>		
Controls	1 A, 90-240 Vac	N/A
* Full Load Peak Amperes at 240 V, 1 Phase	1 A	0 A (air only)
<b>Full Load Peak Amperes (A):</b>		
240 V, 1 Phase		0
240 V, 3 Phase		0
380 V, 3 Phase		0
480 V		0
100-240 V, 1 Phase	1	0

◆ *Wired by user if ordered. Cord size determined by user.*

\* *Full load amperes with all components operating at maximum capabilities. Fuse requirements for various flow rates and heater temperature settings may be less.*

Table 7: Models with 240 Volt Viscon HF Fluid Heater						
Junction Box	Full Load Peak Amperes (A)					
	XM__00	XM__0W	XM__0E	XM__20	XM__2W	XM__2E
240 V, 1 Phase	46	62	59	71	87	84
240 V, 3 Phase	40	55	52	62	76	73
380 V, 3 Phase	23	40	36	48	48	48
480 V						
100-240 V, 1 Phase						

◆ *Models XM\_P, XM\_J only*

Table 8: Models with 480 Volt Viscon HF Fluid Heater						
Junction Box	Full Load Peak Amperes (A)					
	XM__00	XM__0W	XM__0E	XM__20	XM__2W	XM__2E
240 V, 1 Phase						
240 V, 3 Phase						
380 V, 3 Phase						
480 V	20	20	20	26	28	27
100-240 V, 1 Phase						

◆ *Models XM\_K, XM\_F, only*



# Dimensions

## XM System Dimensions without Hoppers (Non-Hazardous Locations)

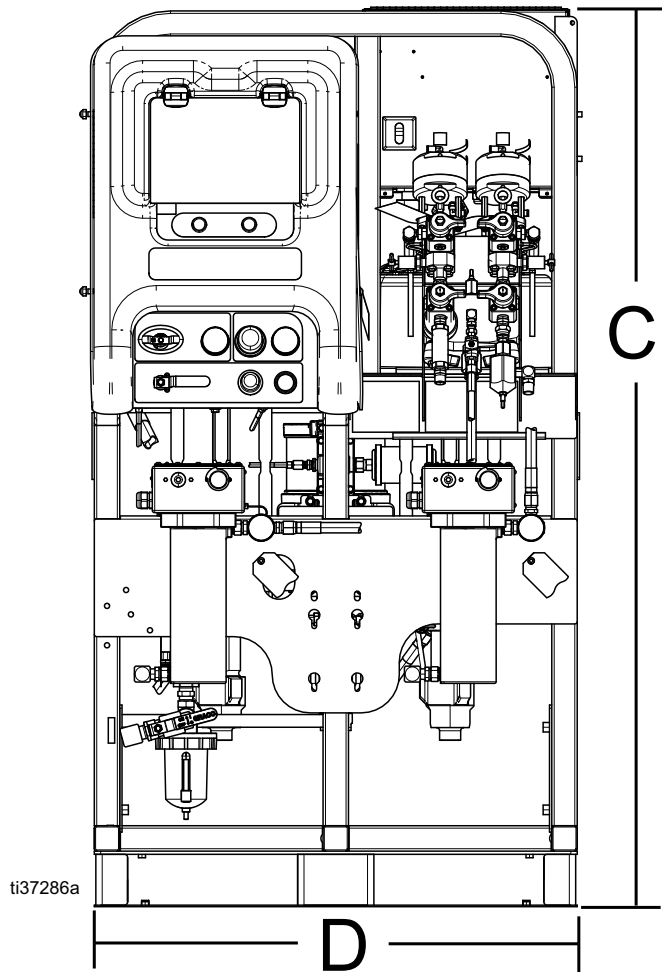
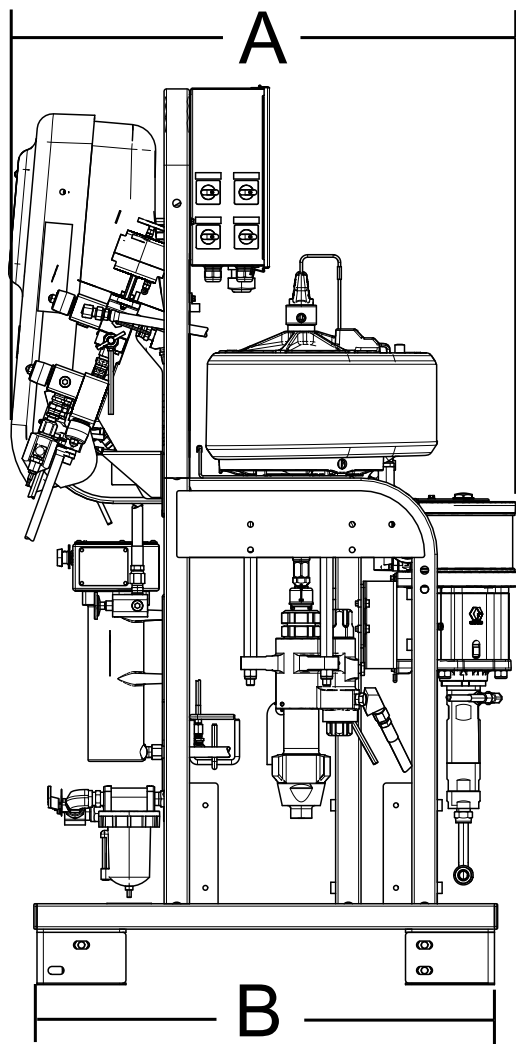

Ref.	Dimensions	
A	39.5 in.	100.3 cm
B	36.0 in.	91.4 cm
C	72.5 in.	184.1 cm
D	38.0 in.	96.5 cm

## XM System Dimensions without Hoppers (Hazardous Locations)

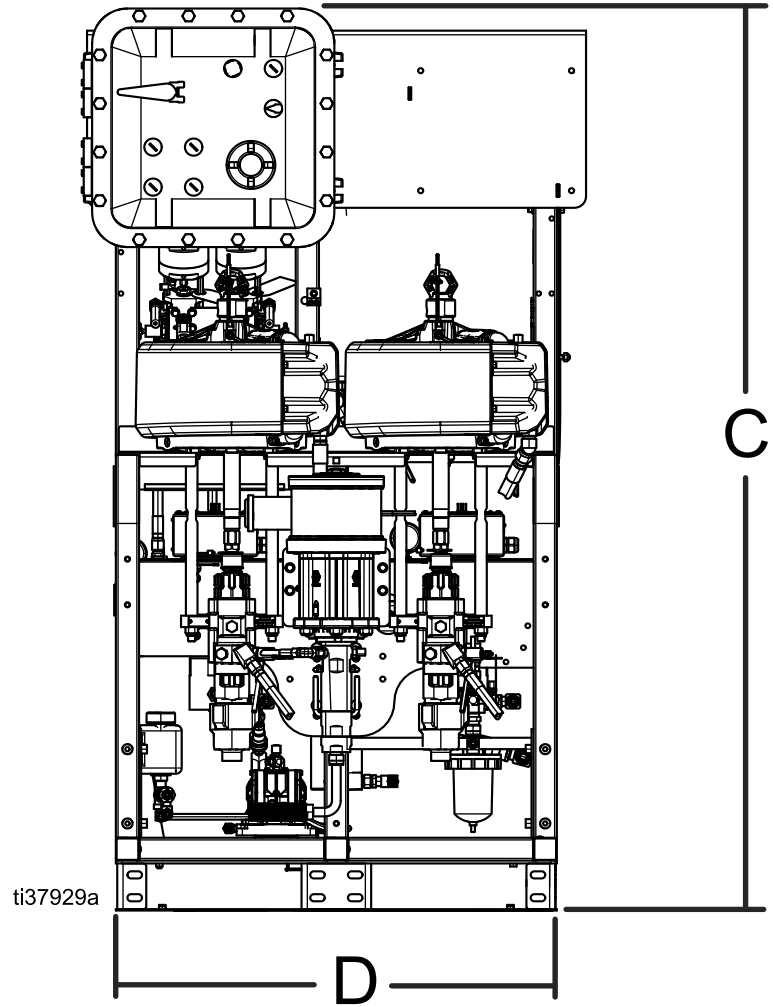
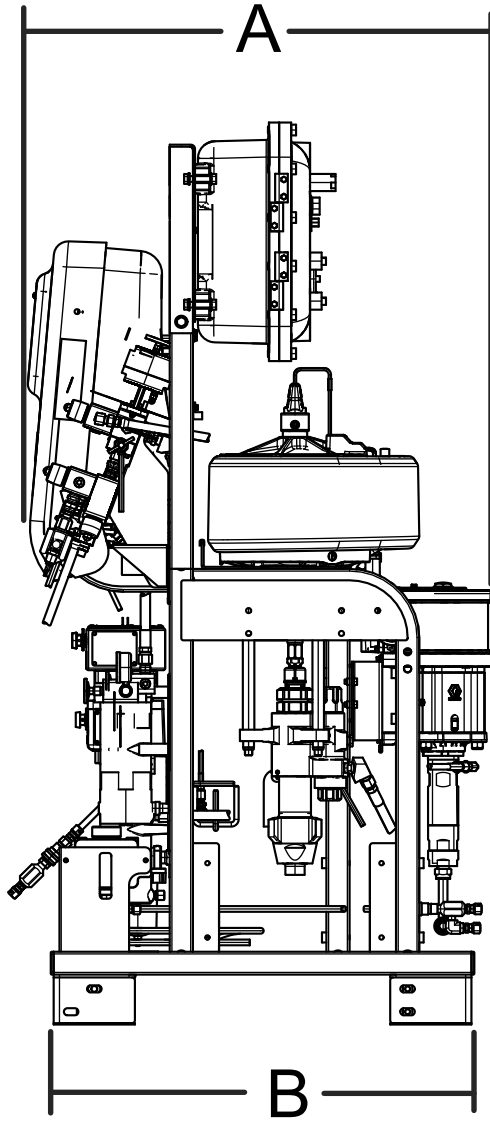

Ref.	Dimensions	
A	39.5 in.	100.3 cm
B	36.0 in.	91.4 cm
C	79.0 in.	200.6 cm
D	38.0 in.	96.5 cm

# 10-Gallon Rear Mount Steel Tank

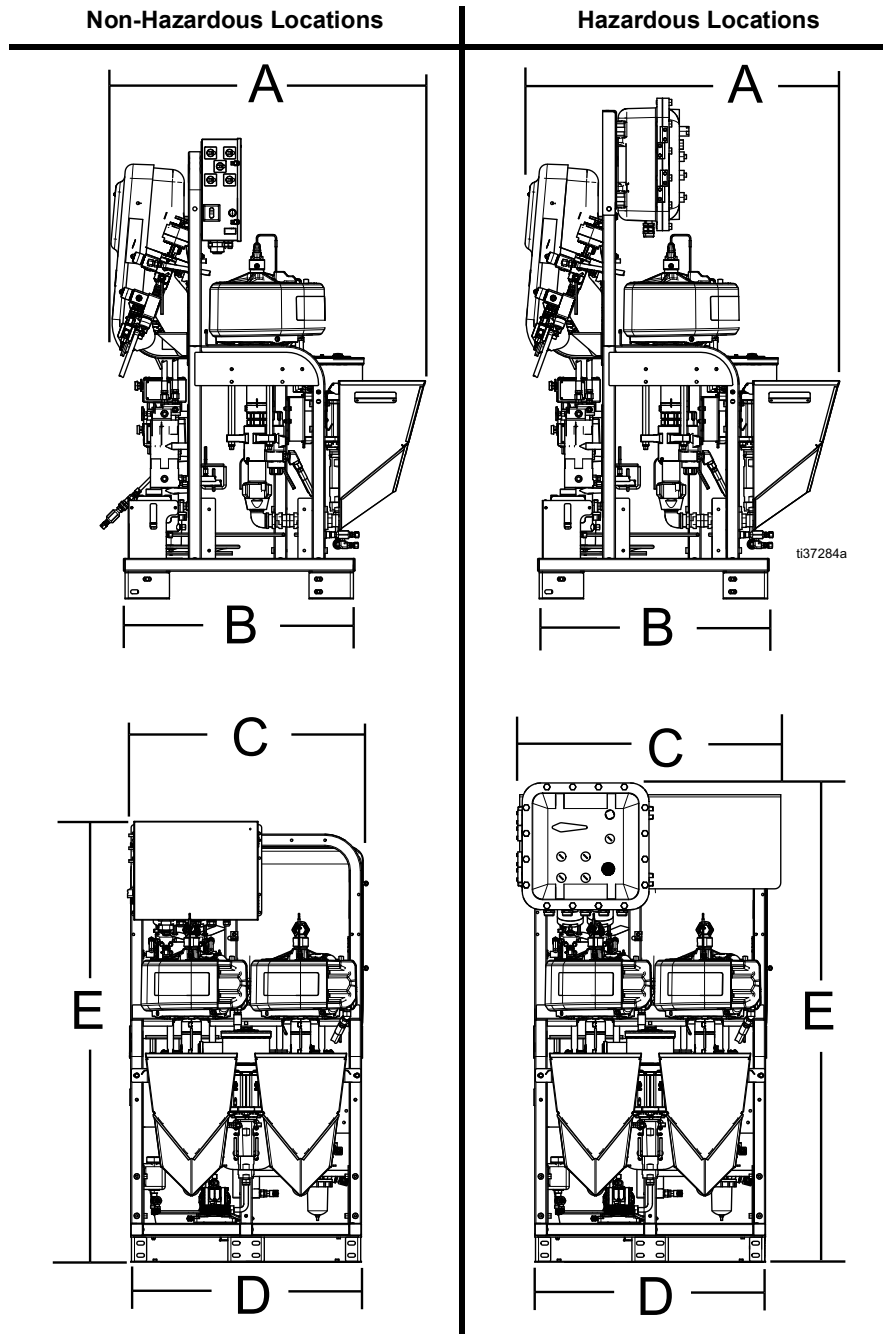

Ref.	Dimensions	
	Non-Hazardous Locations	Hazardous Locations
A	47.5 in. (120.6 cm)	47.5 in. (120.6 cm)
B	36.0 in. (91.4 cm)	36.0 in. (91.4 cm)
C	38.5 in. (97.7 cm)	43.5 in. (110.4 cm)
D	38.0 in. (96.5 cm)	38.0 in. (96.5 cm)
E	72.5 in. (184.1 cm)	79.0 in. (200.6 cm)

## 25-Gallon Rear Mount Steel Tank

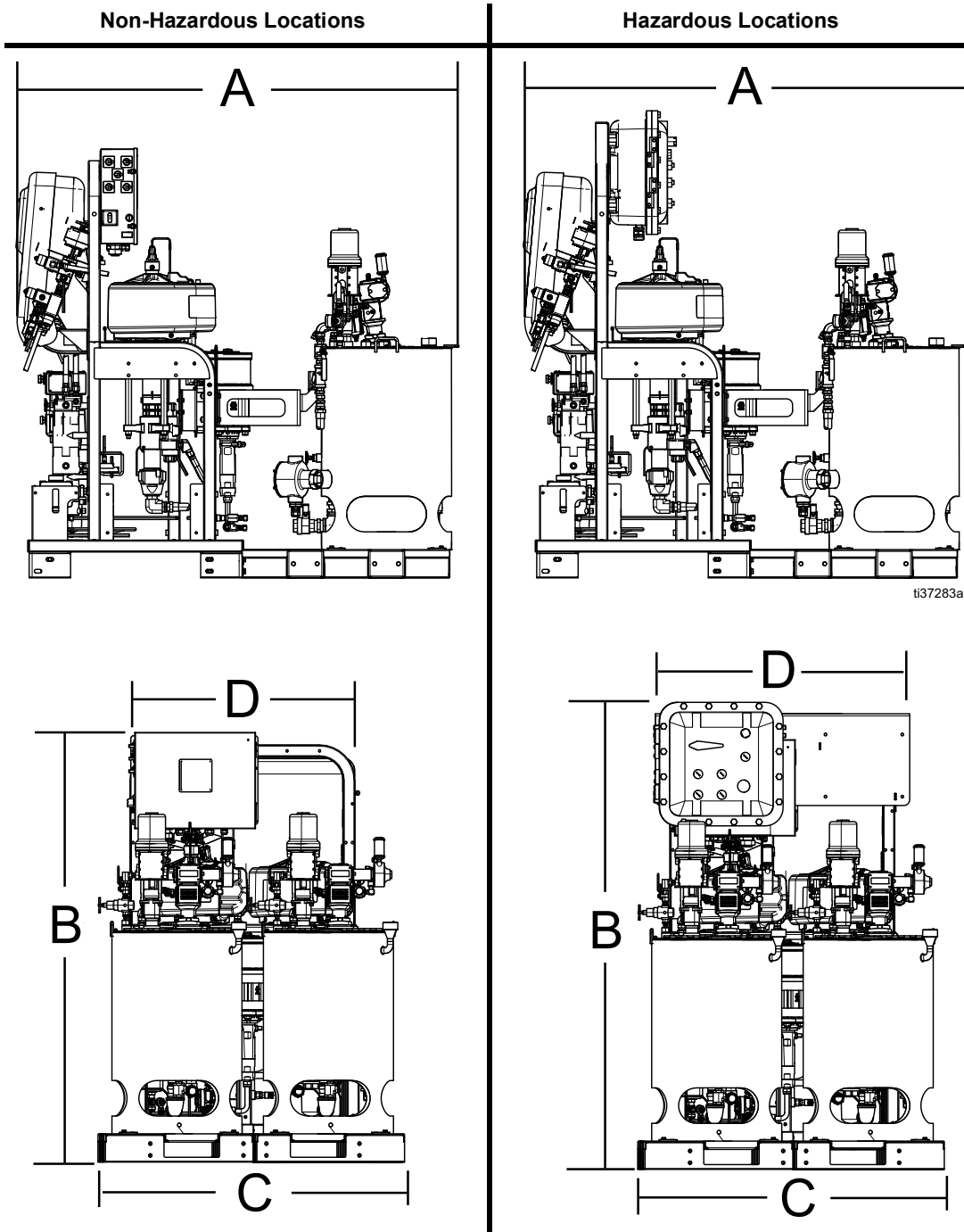

Ref.	Dimensions	
	Non-Hazardous Locations	Hazardous Locations
A	72.5 in. (184.1 cm)	72.5 in. (184.1 cm)
B	72.5 in. (184.1 cm)	79.0 in. (200.6 cm)
C	50.75 in. (128.9 cm)	50.75 in. (128.9 cm)
D	38.5 in. (97.7 cm)	43.5 in. (110.5 cm)

# System Dimensions with Hoppers

Two 20-Gallon Hoppers  
Side Mounted

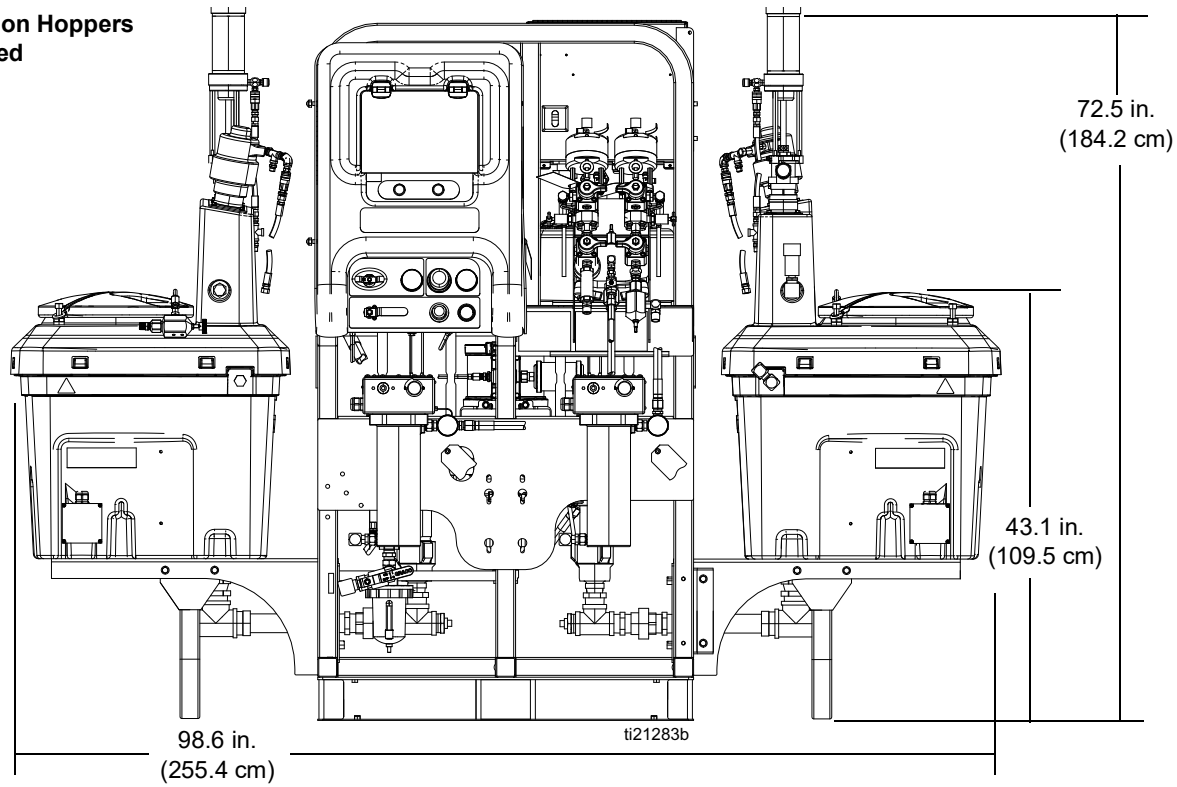

Two 20-Gallon Hoppers  
Rear Mounted  
(Top View)

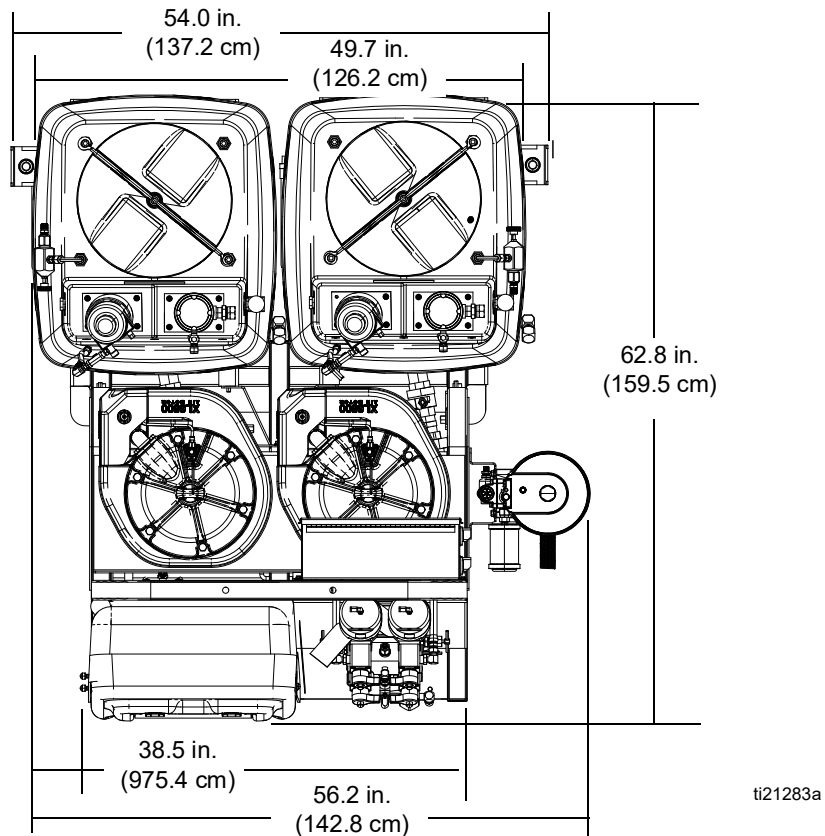

## System Dimensions with Hoppers

### One 20-Gallon Hopper and One 7-Gallon Hopper

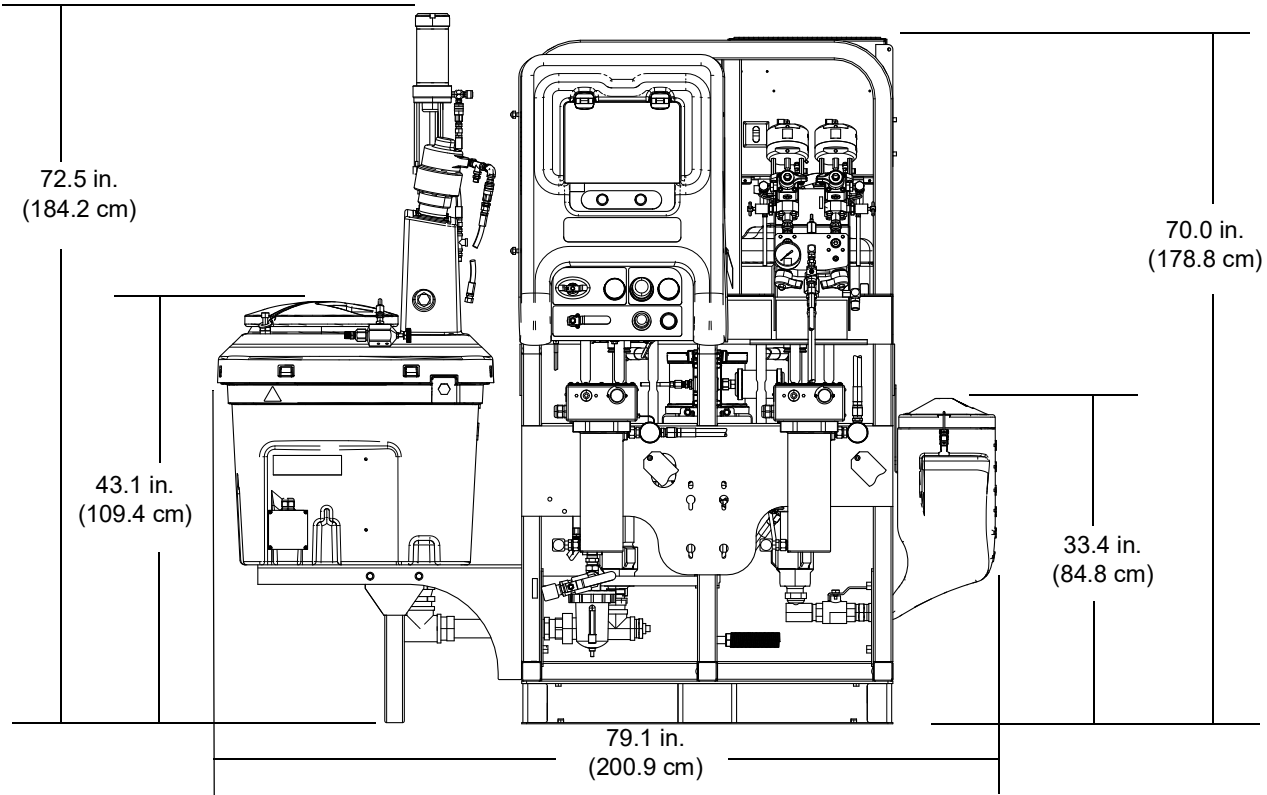

### Two 7-Gallon Hoppers

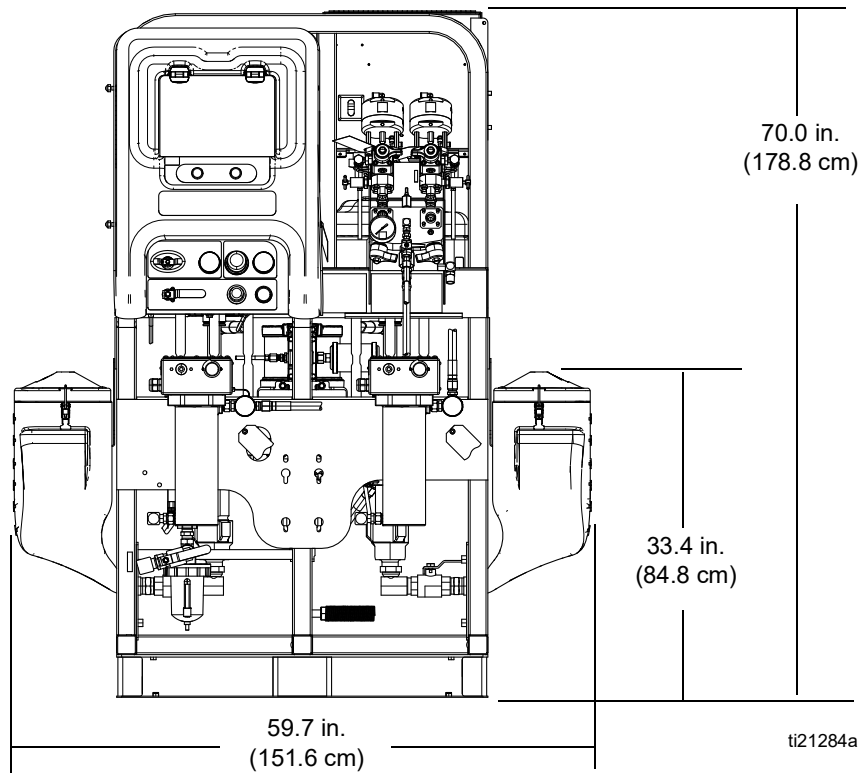

# Pump Performance Charts

## Calculate Fluid Outlet Pressure

To calculate fluid outlet pressure (MPa/bar/psi) at a specific fluid flow (lpm/gpm) and operating air pressure (MPa/bar/psi), use the following instructions and pump data charts.

1. Locate desired flow along bottom of chart.
2. Follow vertical line up to intersection with selected fluid outlet pressure curve. Follow left to scale to read fluid outlet pressure.

## Calculate Pump Air Consumption

To calculate pump air consumption (m<sup>3</sup>/min or scfm) at a specific fluid flow (lpm/gpm) and air pressure (MPa/bar/psi), use the following instructions and pump data charts.

1. Locate desired flow along bottom of chart.
2. Follow vertical line up to intersection with selected air consumption curve. Follow right to scale to read air consumption.

Ratio setpoint has no significant effect on curves in either performance chart.

Air consumption includes turbine alternator; it does not include feed pumps or agitators.

**XM50 Fluid Performance and Air Consumption**

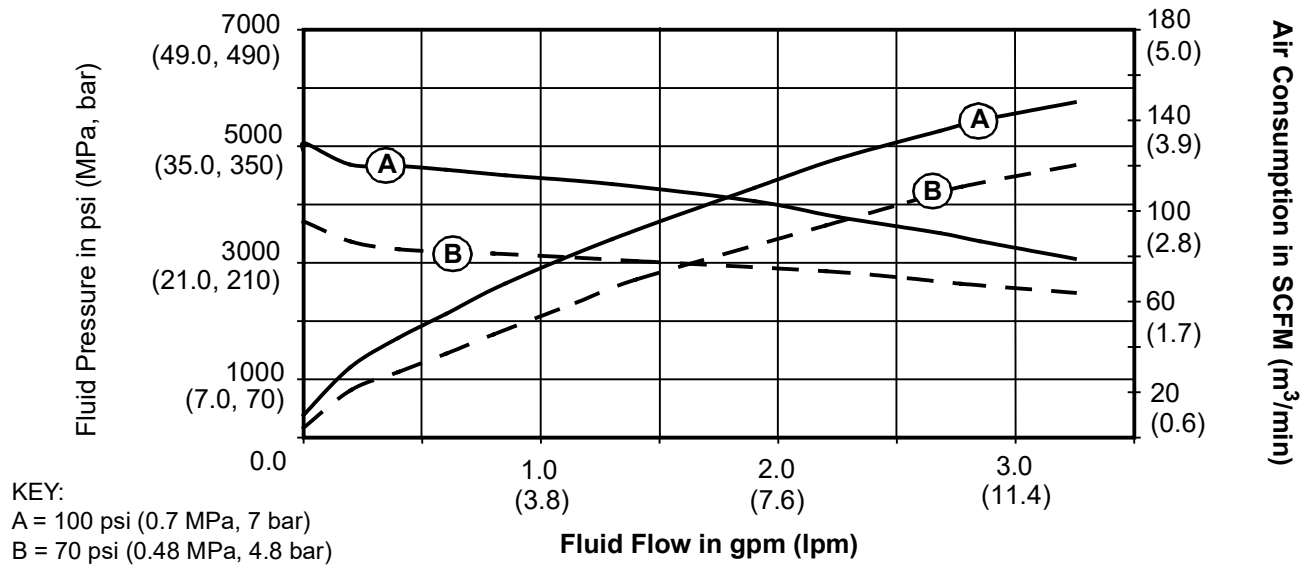

**XM70 Fluid Performance and Air Consumption**

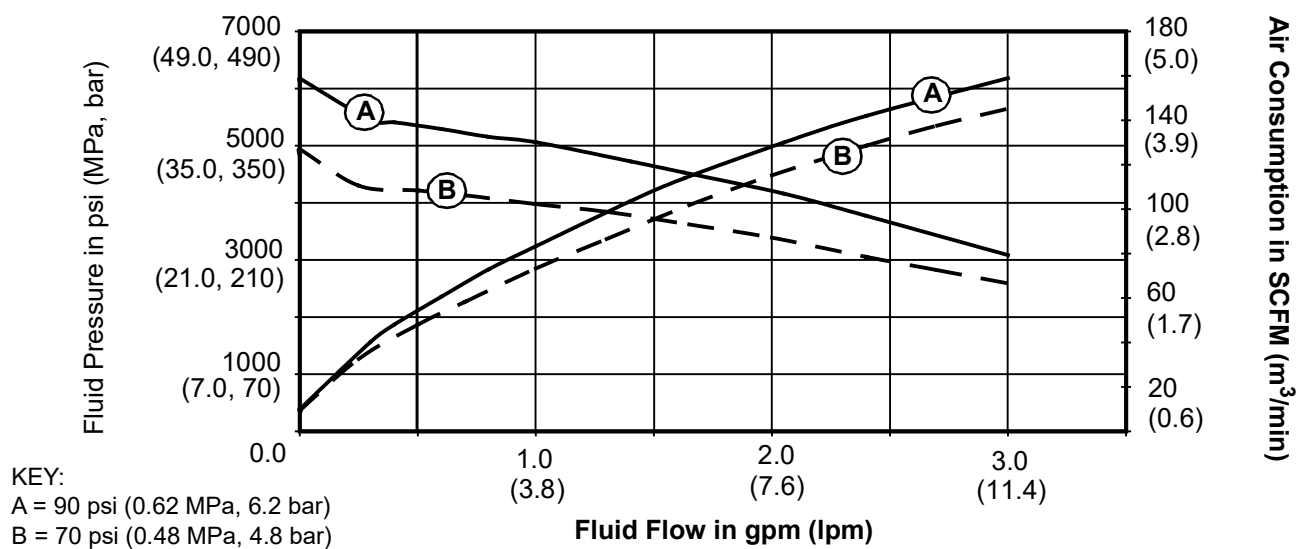

# Technical Specifications

<b>XM Plural-Component Sprayers</b>		
	<b>US</b>	<b>Metric</b>
Mixed Ratio Range	1:1-10:1 (in 0.1 increments)	
Ratio Tolerance Range (before alarm)	+/- 5%	
Fluid Viscosity Range†	200-20,000 cps (heavier viscosities can be mixed using heat, circulation, and/or pressure feeding)	
Fluid filtration, standard on pump outlets*	60 mesh	238 micron
Air Filtration	40 micron main filter, 5 micron control air filter; see <b>Pump Performance Charts</b> , page 103	
<b>Weight</b>		
Weight: Base sprayer (XM1L00, XM1N00 models) Add component weights to base sprayer weight for your specific model weight.	742 lb	336.87 kg
<b>Dimensions</b>		
See <b>Dimensions</b> , page 97		
<b>Inlet/Outlet Sizes</b>		
Air inlet size	3/4 in. npt(f)	
Fluid inlet size, without feed kits	1 1/4 npt(m)	
<b>Ambient temperature range</b>		
Operating	32-130 °F	0-54 °C
Storage	30-160 °F	-1-71 °C
<b>Maximum fluid working pressure of mixed material</b>		
50:1	5200 psi	35.8 MPa, 358 bar
70:1	6300 psi	43.5 MPa, 435 bar
Maximum Pump Inlet Fluid Feed Pressure	250 psi	1.7 MPa, 17 bar
Maximum Fluid Temperature	160 °F	71 °C
<b>Maximum pump air set pressure</b>		
50:1	100 psi	0.68 MPa, 6.8 bar
70:1	90 psi	0.62 MPa, 6.2 bar
Air Supply Pressure Range	50-150 psi	0.35-1.0 MPa, 3.5-10.3 bar
Maximum Air Consumption at 100 psi (0.7 MPa, 7.0 bar) in scfm (m <sup>3</sup> /min.)	70 scfm per gpm (1.96 m <sup>3</sup> /min. per lpm)	
<b>Flow Rates</b>		
Minimum* *	1 quart per minute	0.95 liters per minute
Maximum	3 gallons per minute	11.4 liters per minute
<b>Notes</b>		
† Heavier viscosities can be mixed using heat, circulation, and pressure feeding.		
* Filter assembly is not included on some models.		
* * Minimum flow rate is dependent on material being sprayed and mixing capability. Test your material specific to flow rate.		
<b>Environmental conditions rating</b>		
Indoor/outdoor use		
Altitude	Up to 4000 m	
Maximum relative humidity	To 99% up to 130°F	To 99% up to 54°C



<b>XM Plural-Component Sprayers</b>		
	<b>US</b>	<b>Metric</b>
Pollution degree		11
Installation category		2
<b>Noise dB(A)</b>		
Operating Pressure 70 psi (0.48 MPa, 4.8 bar)		
Sound pressure		84.8 dB(A)
Sound power measured per ISO 3744		95.1 dB(A)
Operating Pressure 100 psi (0.7 MPa, 7 bar)		
Sound pressure		91.7 dB(A)
Sound power measured per ISO 3744		102.0 dB(A)
<b>Notes</b>		
All trademarks or registered trademarks are the property of their respective owners.		
<b>Storage</b>		
Maximum storage time	5 years	
Storage maintenance	To maintain original performance, replace soft seals after 5 years of inactivity.	
Ambient storage temperature range	30 to 160°F	(1) to 71°C
Lifetime	Lifetime varies with use, materials sprayed, storage methods, and maintenance. Life minimum is 25 years.	
Lifetime service maintenance	Replace leather packings every five years or less based on use.	
End of life disposal	If the sprayer is in a condition that it can no longer operate, the sprayer should be taken out of service and dismantled. Individual parts should be sorted by material and disposed of properly. Electronic components are RoHS compliant and should be disposed of properly.	
<b>Graco Four Character Date Code</b>		
Example: A18B	Month (first character) A=January, Year (second and third character) 18=2018, Series (fourth character) B=serial control number.	
<b>Materials</b>		
Wetted Parts	Aluminum, acetal, ductile iron, leather, nylon, plated carbon steel, PTFE, stainless steel, tungsten carbide, UHMWPE	

## California Proposition 65

### CALIFORNIA RESIDENTS

 **WARNING:** Cancer and reproductive harm – [www.P65warnings.ca.gov](http://www.P65warnings.ca.gov).

# Graco Standard Warranty

Graco warrants all equipment referenced in this document which is manufactured by Graco and bearing its name to be free from defects in material and workmanship on the date of sale to the original purchaser for use. With the exception of any special, extended, or limited warranty published by Graco, Graco will, for a period of twelve months from the date of sale, repair or replace any part of the equipment determined by Graco to be defective. This warranty applies only when the equipment is installed, operated and maintained in accordance with Graco's written recommendations.

This warranty does not cover, and Graco shall not be liable for general wear and tear, or any malfunction, damage or wear caused by faulty installation, misapplication, abrasion, corrosion, inadequate or improper maintenance, negligence, accident, tampering, or substitution of non-Graco component parts. Nor shall Graco be liable for malfunction, damage or wear caused by the incompatibility of Graco equipment with structures, accessories, equipment or materials not supplied by Graco, or the improper design, manufacture, installation, operation or maintenance of structures, accessories, equipment or materials not supplied by Graco.

This warranty is conditioned upon the prepaid return of the equipment claimed to be defective to an authorized Graco distributor for verification of the claimed defect. If the claimed defect is verified, Graco will repair or replace free of charge any defective parts. The equipment will be returned to the original purchaser transportation prepaid. If inspection of the equipment does not disclose any defect in material or workmanship, repairs will be made at a reasonable charge, which charges may include the costs of parts, labor, and transportation.

**THIS WARRANTY IS EXCLUSIVE, AND IS IN LIEU OF ANY OTHER WARRANTIES, EXPRESS OR IMPLIED, INCLUDING BUT NOT LIMITED TO WARRANTY OF MERCHANTABILITY OR WARRANTY OF FITNESS FOR A PARTICULAR PURPOSE.**

Graco's sole obligation and buyer's sole remedy for any breach of warranty shall be as set forth above. The buyer agrees that no other remedy (including, but not limited to, incidental or consequential damages for lost profits, lost sales, injury to person or property, or any other incidental or consequential loss) shall be available. Any action for breach of warranty must be brought within two (2) years of the date of sale.

**GRACO MAKES NO WARRANTY, AND DISCLAIMS ALL IMPLIED WARRANTIES OF MERCHANTABILITY AND FITNESS FOR A PARTICULAR PURPOSE, IN CONNECTION WITH ACCESSORIES, EQUIPMENT, MATERIALS OR COMPONENTS SOLD BUT NOT MANUFACTURED BY GRACO.** These items sold, but not manufactured by Graco (such as electric motors, switches, hose, etc.), are subject to the warranty, if any, of their manufacturer. Graco will provide purchaser with reasonable assistance in making any claim for breach of these warranties.

In no event will Graco be liable for indirect, incidental, special or consequential damages resulting from Graco supplying equipment hereunder, or the furnishing, performance, or use of any products or other goods sold hereto, whether due to a breach of contract, breach of warranty, the negligence of Graco, or otherwise.

## **FOR GRACO CANADA CUSTOMERS**

The Parties acknowledge that they have required that the present document, as well as all documents, notices and legal proceedings entered into, given or instituted pursuant hereto or relating directly or indirectly hereto, be drawn up in English. Les parties reconnaissent avoir convenu que la rédaction du présente document sera en Anglais, ainsi que tous documents, avis et procédures judiciaires exécutés, donnés ou intentés, à la suite de ou en rapport, directement ou indirectement, avec les procédures concernées.

# Graco Information

For the latest information about Graco products, visit [www.graco.com](http://www.graco.com).

For patent information, see [www.graco.com/patents](http://www.graco.com/patents).

**TO PLACE AN ORDER, contact your Graco distributor or call to identify the nearest distributor.**

**Phone: 612-623-6921 or Toll Free: 1-800-328-0211 Fax: 612-378-3505**

*All written and visual data contained in this document reflects the latest product information available at the time of publication. Graco reserves the right to make changes at any time without notice.*

Original instructions. This manual contains English. MM 312359

**Graco Headquarters:** Minneapolis

**International Offices:** Belgium, China, Japan, Korea

**GRACO INC. AND SUBSIDIARIES • P.O. BOX 1441 • MINNEAPOLIS MN 55440-1441 • USA**  
**Copyright 2021, Graco Inc. All Graco manufacturing locations are registered to ISO 9001.**

[www.graco.com](http://www.graco.com)  
Revision U, February 2024