



The manual provided with this sprayer contains English and Español.



Visit our website;  
<http://MAGNUM.Graco.com>

## Project Painter 5 Airless Sprayer

# 312079A

***For portable spray applications of architectural paints and coatings***

### Model: 261800

Maximum Working Pressure: 2800 psi (19 MPa, 193 bar)

Dispense Rate: 0.24 gpm (0.91 lpm)

### Includes:

Gun: SG10

Hose: 1/4 inch x 25-ft. (6.4 mm x 7.5 m)

9 inch Pressure Roller Attachment



### IMPORTANT SAFETY INSTRUCTIONS.

Read all warnings and instructions in this manual. Save these instructions.

--	--	--	--	--	--	--

Use water-based or mineral spirit-type materials only. Do not use materials having flash points lower than 70°F (21°C). For more information about your material request MSDS from distributor or retailer.

### Specifications



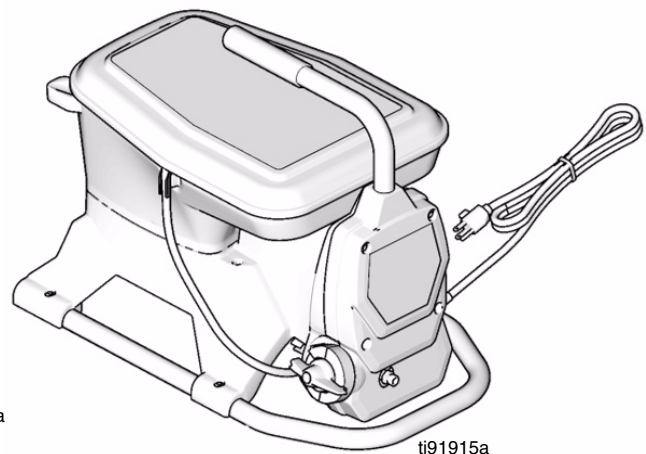
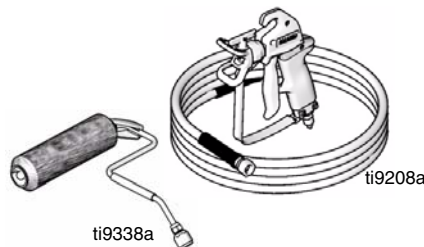

*This equipment is not intended for use with flammable or combustible materials used in places such as cabinet shops or other "factory" or fixed locations. If you intend to use this equipment in this type of application, you must comply with NFPA33 and OSHA requirements for the use of flammable and combustible materials.*



PROVEN QUALITY. LEADING TECHNOLOGY.

## Warnings

The following warnings are for the setup, use, grounding, maintenance, and repair of this equipment. The exclamation point symbol alerts you to a general warning and the hazard symbols refer to procedure-specific risks. Refer back to these warnings. Additional, product specific warnings may be found throughout the body of this manual where applicable.

 <b>WARNING</b>	
	<p><b>FIRE AND EXPLOSION HAZARD</b></p> <p>Flammable fumes, such as solvent and paint fumes, in work area can ignite or explode. To help prevent fire and explosion:</p> <ul style="list-style-type: none"> <li>• Use equipment only in well ventilated area.</li> <li>• Eliminate all ignition sources; such as pilot lights, cigarettes, portable electric lamps, and plastic drop cloths (potential static arc).</li> <li>• Sprayer generates sparks. When flammable liquid is used in or near the sprayer or for flushing or cleaning, keep sprayer at least 20 feet (6 m) away from explosive vapors.</li> <li>• Keep work area free of debris, including solvent, rags and gasoline.</li> <li>• Do not plug or unplug power cords or turn lights on or off when flammable fumes are present.</li> <li>• Ground equipment and conductive objects in work area. Read <b>Grounding</b> instructions.</li> <li>• If there is static sparking or you feel a shock, <b>stop operation immediately</b>. Do not use equipment until you identify and correct the problem.</li> <li>• Keep a fire extinguisher in the work area.</li> </ul>
	<p><b>ELECTRIC SHOCK HAZARD</b></p> <p>Improper grounding, setup, or usage of the system can cause electric shock.</p> <ul style="list-style-type: none"> <li>• Turn off and disconnect power cord before servicing equipment.</li> <li>• Use only grounded electrical outlets.</li> <li>• Use only 3-wire extension cords.</li> <li>• Ensure ground prongs are intact on sprayer and extension cords.</li> <li>• Do not expose to rain. Store indoors.</li> </ul>
	<p><b>SKIN INJECTION HAZARD</b></p> <p>High-pressure fluid from gun, hose leaks, or ruptured components will pierce skin. This may look like just a cut, but it is a serious injury that can result in amputation. <b>Get immediate surgical treatment.</b></p> <ul style="list-style-type: none"> <li>• Do not point gun at anyone or at any part of the body.</li> <li>• Do not put your hand over the spray tip.</li> <li>• Do not stop or deflect leaks with your hand, body, glove, or rag.</li> <li>• Engage trigger lock when not spraying.</li> <li>• Follow <b>Pressure Relief Procedure</b> in this manual, when you stop spraying and before cleaning, checking, or servicing equipment.</li> </ul>

 **WARNING**
**EQUIPMENT MISUSE HAZARD**

Misuse can cause death or serious injury.

- Do not exceed the maximum working pressure or temperature rating of the lowest rated system component. Read **Technical Data** in all equipment manuals.
- Use fluids and solvents that are compatible with equipment wetted parts. Read **Technical Data** in all equipment manuals. Read fluid and solvent manufacturer's warnings. For complete information about your material, request MSDS from distributor or retailer.
- Check equipment daily. Repair or replace worn or damaged parts immediately with genuine Graco replacement parts only.
- Do not alter or modify equipment.
- Use equipment only for its intended purpose. Call your Graco distributor for information.
- Route hoses and cables away from traffic areas, sharp edges, moving parts, and hot surfaces.
- Do not kink or overbend hoses or use hoses to pull equipment.
- Comply with all applicable safety regulations.
- Keep children and animals away from work area.
- Do not operate the unity when fatigued or under the influence of drugs or alcohol.

**PRESSURIZED ALUMINUM PARTS HAZARD**

Do not use 1,1,1-trichloroethane, methylene chloride, other halogenated hydrocarbon solvents or fluids containing such solvents in pressurized aluminum equipment. Such use can cause serious chemical reaction and equipment rupture, and result in death, serious injury, and property damage.

**TOXIC FLUID OR FUMES HAZARD**

Toxic fluids or fumes can cause serious injury or death if splashed in the eyes or on skin, inhaled, or swallowed.

- Read MSDS's to know the specific hazards of the fluids you are using.
- Store hazardous fluid in approved containers, and dispose of it according to applicable guidelines.

**PERSONAL PROTECTIVE EQUIPMENT**

You must wear appropriate protective equipment when operating, servicing, or when in the operating area of the equipment to help protect you from serious injury, including eye injury, inhalation of toxic fumes, burns, and hearing loss. This equipment includes but is not limited to:

- Protective eye wear
- Clothing and respirator as recommended by the fluid and solvent manufacturer
- Gloves
- Hearing protection

# Installation

## Grounding and Electric Requirements

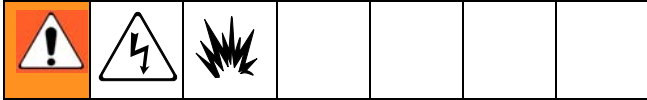

**Sprayer** must be grounded. Grounding reduces the risk of static and electric shock by providing an escape wire for electrical current due to static build up or in the event of a short circuit.

- The 120 Vac sprayers require a 120 Vac, 60 Hz, 15A circuit with a grounding receptacle.

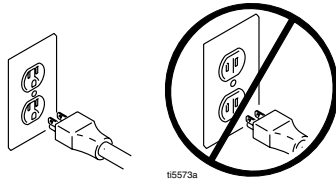

- Never use an outlet that is not grounded or an adapter.

- Do not use the sprayer if the electrical cord has a damaged ground prong.

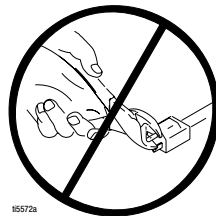

- Only use an extension cord with an undamaged 3-prong plug.

Recommended extension cords for use with this sprayer:

- 50 ft (15.0 m) 16 AWG (1.0 mm<sup>2</sup>)
- 100 ft (30.0 m) 14 AWG (1.5 mm<sup>2</sup>)

 Smaller gauge or longer extension cords may reduce sprayer performance.

**Spray gun:** ground through connection to a properly grounded fluid hose and pump.

**Fluid supply container:** follow local code.

**Solvent pails used when flushing:** follow local code. Use only conductive metal pails, placed on a grounded surface such as concrete. Do not place the pail on a nonconductive surface, such as paper or cardboard, which interrupts grounding continuity.

**Grounding the metal pail:** connect a ground wire to the pail by clamping one end to pail and other end to ground such as a water pipe.

**Maintaining grounding continuity when flushing or relieving pressure:** hold metal part of the spray gun firmly to the side of a grounded metal pail, then trigger the gun.



## Thermal Overload

Motor has a thermal overload switch to shut itself down if overheated. If unit overheats, allow approximately 45 minutes for unit to cool. Once cool, switch will close and unit will restart.

						
To reduce the risk of injury from motor starting unexpectedly when it cools, always turn power switch OFF if motor shuts down.						

# Component Identification

## Project Painter 5

A	AllControl™	<ul style="list-style-type: none"> <li>• STORAGE: for long term or overnight shutdown and storage.</li> <li>• OFF: turns motor off for short term shutdown and relieves system pressure.</li> <li>• PRIME/CLEAN PUMP: turns on motor and directs fluid to prime tube.</li> <li>• ROLL: directs low pressure fluid to roller (when used)</li> <li>• PRIME/CLEAN GUN &amp; HOSE: directs fluid to gun and hose.</li> <li>• LOW SPRAY to HIGH SPRAY: directs fluid to spray gun.</li> </ul>
B	Pump fluid outlet fitting	Threaded connection for paint hose.
C	Suction tube	Draws fluid from paint pail or hopper into pump.
D	Prime tube (with diffuser)	Drains fluid in system during priming and pressure relief.
E	Inlet screen	Prevents debris from entering pump.
E1	Inlet screen handle	Aids in the installation and removal of the inlet screen.
F	Hopper cover	Prevents debris from entering hopper.
G	Pour spouts	Directs paint out of hopper and back into paint container.
H	Hopper	2.5 gal. (9.5 L) capacity hopper that holds paint.
J	Tip holder	Storage for 2 spray tips.
K	Hopper handle	Press and turn handle to allow access to hopper and paint tray.
L	Paint tray	Built in paint tray to rest roller attachment when not in use.
M	Disposable hopper liner	Fits directly in hopper and is disposable for simple cleanup.
N	Practice Spray Board	Instructs user on how to perform basic spraying techniques and provides surface to practice techniques prior to spraying surfaces.
P	Power Flush™ attachment	Connects garden hose to suction tube for power flushing water-base fluids.
R	Paint hose	Transports high-pressure fluid from pump to spray gun.
S	Airless spray gun	Dispenses fluid.
T	Tip guard	Reduces risk of fluid injection injury.
U	Reversible spray tip	<ul style="list-style-type: none"> <li>• Atomizes fluid being sprayed, forms spray pattern and controls fluid flow according to hole size.</li> <li>• When reversed, unclogs plugged tips without disassembly.</li> </ul>
V	Gun fluid filter	Filters fluid entering spray gun to reduce tip clogs.
W	Roller attachment	Attaches to spray gun for pressure rolling directly on surfaces.
X	Gun trigger safety lever (page 7)	Prevents accidental triggering of spray gun.

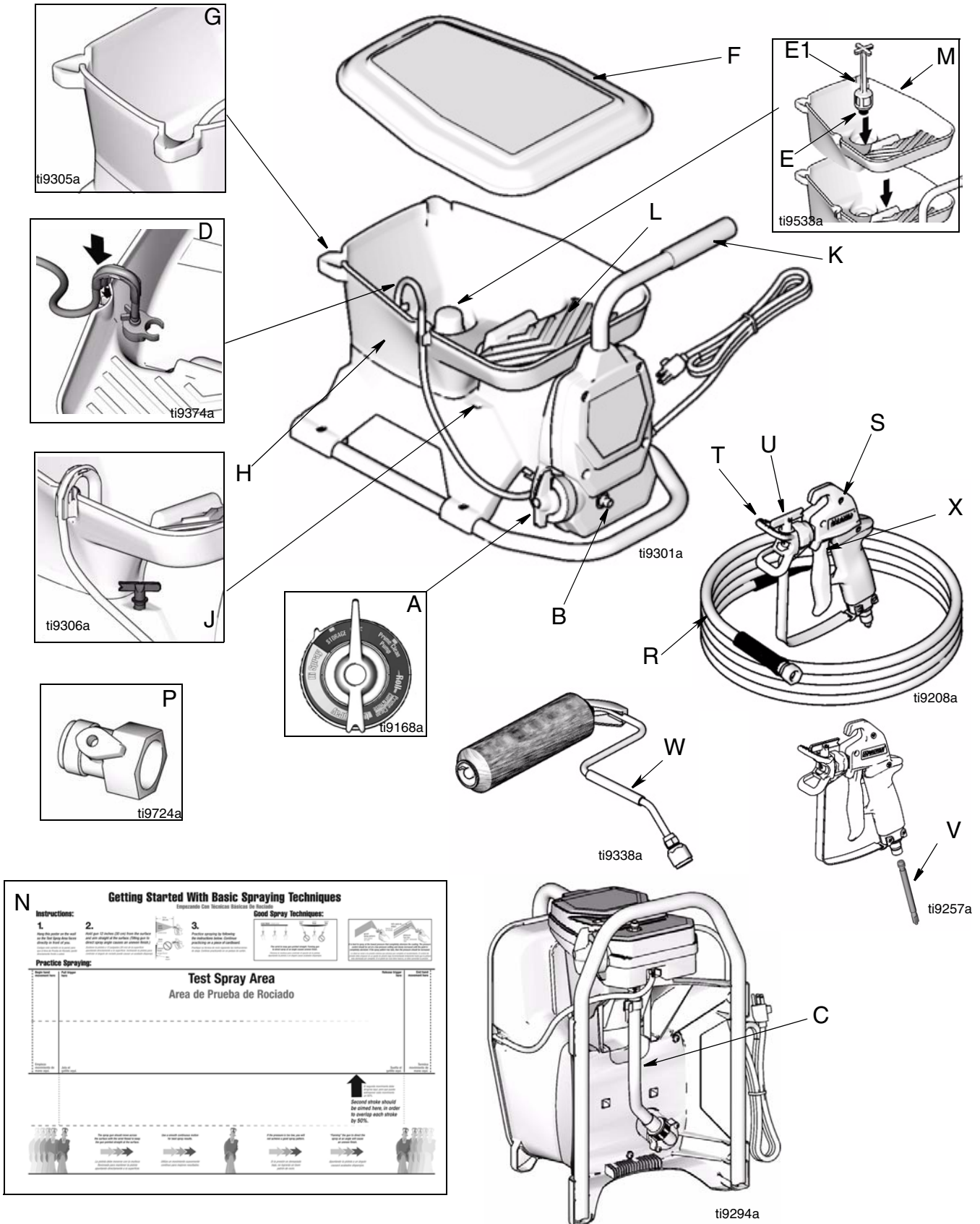

Bottom view and position for direct immersion mode



# Getting Started

## Pressure Relief Procedure

Follow this Pressure Relief Procedure when you stop spraying and before cleaning, checking, servicing, or transporting equipment.

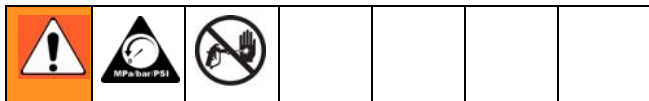

1. Set AllControl to OFF.  
Unplug sprayer.



2. Hold gun firmly to the side of a pail. Trigger the gun to relieve pressure.
3. Engage trigger lock. See Trigger Lock, page 7.

*If you suspect the spray tip or hose is clogged or that pressure has not been fully relieved after following the previous steps, VERY SLOWLY loosen tip guard retaining nut or hose end coupling to relieve pressure gradually, then loosen completely. Clear hose or tip obstruction. Read Unclogging Spray Tip, page 14.*

## Trigger Lock

Always engage the trigger lock when you stop spraying to prevent the gun from being triggered accidentally by hand or if dropped or bumped.

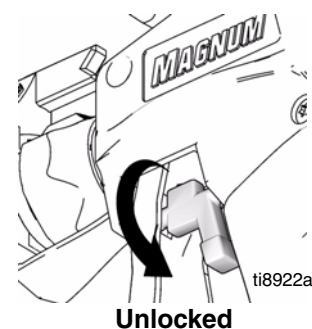
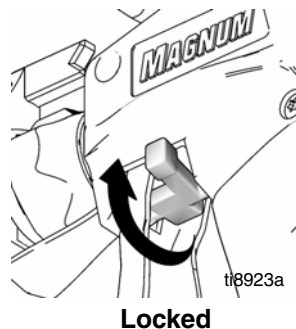

# AllControl™ Settings

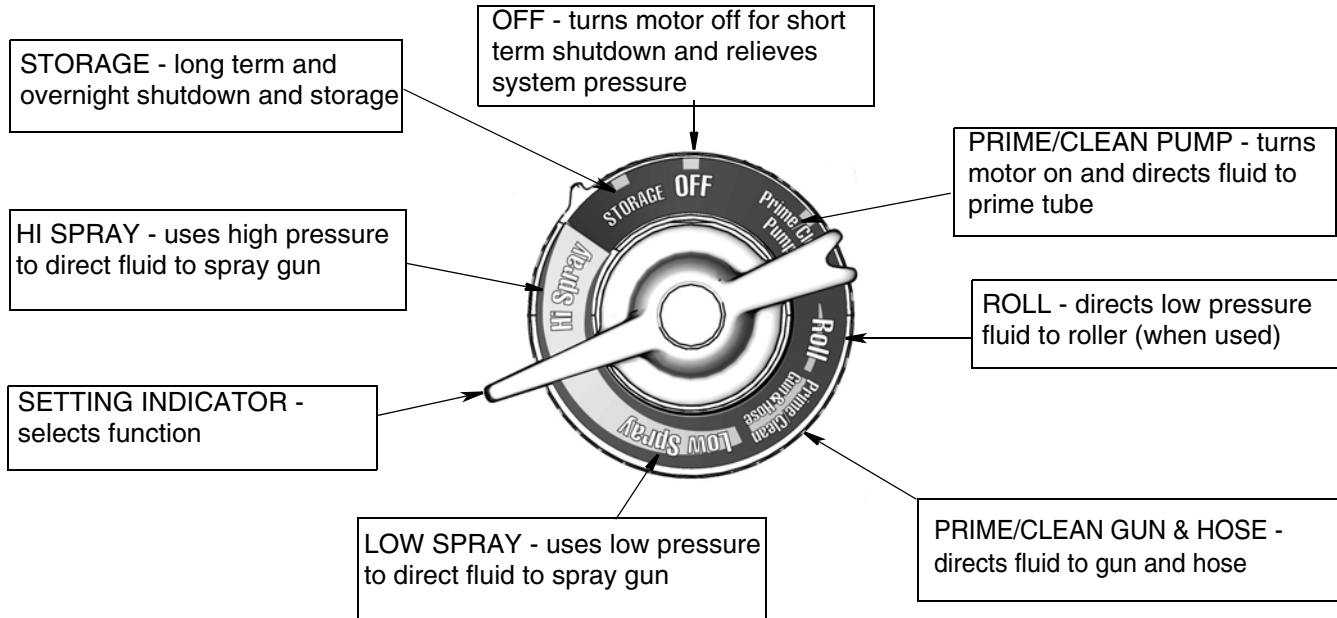

## Setup

Project Painter 5 can be used as either a hopper or direct immersion sprayer.

### Hopper Method (Primary Spray Method)

- Stand sprayer upright to verify the suction tube is securely and properly connected to fitting (a) and hopper elbow (b). If they are not, connect suction tube and tighten securely.

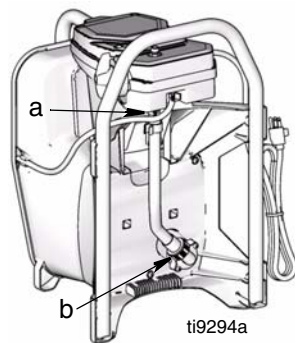

- Return sprayer to horizontal position.

- Set AllControl to OFF. Engage gun trigger lock.



- Unscrew tip and guard assembly from gun.



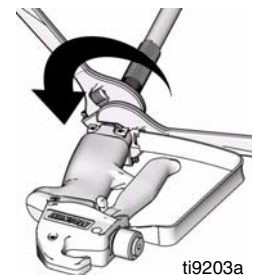

- Uncoil hose and connect one end to gun. Use two wrenches to tighten securely.



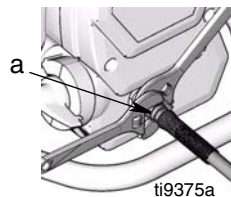

- Connect other end of hose to sprayer (a). Use two wrenches to tighten securely.



 If hose is already connected, make sure connections are tight.

- Push down on bend of handle and pivot 90°. Remove cover.



- Unclip drain tube from side of hopper and place in waste pail.

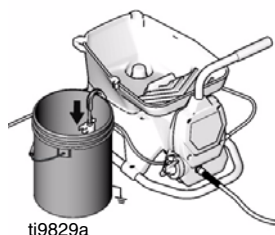

- Install liner (c) in hopper (optional).

- Use inlet screen handle (d) to install inlet screen into opening in bottom of hopper.

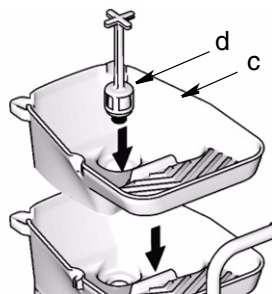

**NOTE:** If using a liner, be sure liner is in place before you install inlet screen. The inlet screen will hold the liner in place and help prevent paint from seeping between the liner and the hopper for easier cleanup.

## Priming and Flushing Storage Fluid (Hopper Method)

Before you use your sprayer for the first time or begin a new spraying project, you need to prime the sprayer and flush the storage fluid out of the sprayer.

### Oil- or Water-based Materials

-  When spraying **water-based** materials, flush the system thoroughly with water.
- When spraying **oil-based** materials, flush the system thoroughly with mineral spirits or compatible, oil-based flushing solvent.
- To spray **water-based** materials **after spraying oil-based** materials, flush the system thoroughly with water first. The water flowing out of prime tube should be clear and solvent-free **before** you begin spraying the water-based material.
- To spray **oil-based** materials **after spraying water-based** materials, flush the system thoroughly with mineral spirits or a compatible oil-based flushing solvent first. The solvent flowing out of the prime tube should not contain any water.
- When flushing with solvents, ground gun. Read Grounding and Electric Requirements, page 4.
- To avoid fluid splashing back on your skin or into your eyes, always aim gun at inside wall of pail.

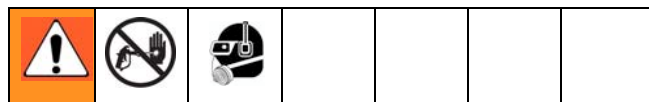

- Make sure AllControl is set to OFF and sprayer is unplugged.



2. Fill hopper with water or compatible flushing solvent.



3. Plug sprayer in a grounded outlet.

4. Turn AllControl to PRIME/CLEAN PUMP.



5. When sprayer starts pumping, water or flushing solvent and air bubbles will be purged from the system. Allow fluid to drain out of prime tube, into waste pail, until all fluid has drained out of hopper. Pour out any remaining fluid.

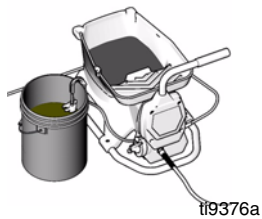

6. Turn AllControl to OFF.



7. Fill hopper with paint.



8. Turn AllControl to PRIME/CLEAN PUMP.



9. When paint comes out of drain tube, turn AllControl to OFF.



10. Clip drain tube to side of hopper.

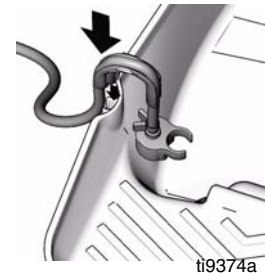

11. Point gun into waste pail.

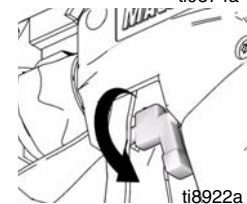

12. Unlock gun trigger lock.

13. Pull and hold gun trigger.

14. Set AllControl to PRIME/CLEAN GUN & HOSE.

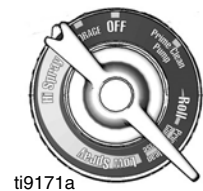

15. Continue to trigger into waste pail until you see only paint coming out of gun.

16. Release trigger. Engage trigger lock.

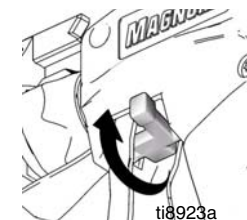

17. If spraying, install tip and guard on gun, page 13 and see Spraying Techniques, page 14.

If rolling, roller setup and Rolling Techniques, begin on page 18.

## Direct Immersion Setup (Alternate Spray Method)

1. Set AllControl to OFF.



2. Push down on bend of handle and pivot 90°. Remove cover.



3. Use inlet screen handle to unscrew and remove inlet screen from hopper.



4. Unclip drain tube from side of hopper.

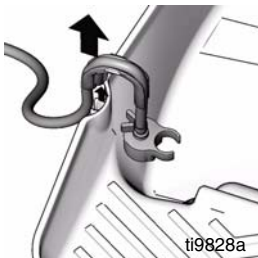

5. Replace hopper cover and return handle to locked position.

6. Stand sprayer upright in immersion spray position.



7. Unscrew suction tube fitting from hopper elbow (b).

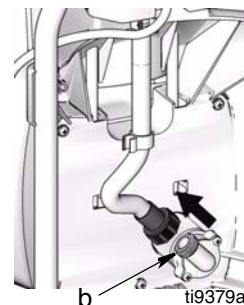

8. Install inlet screen into end of suction tube.



9. Engage gun trigger lock.

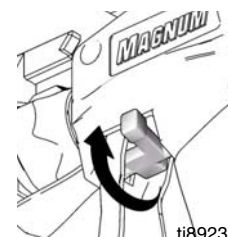

10. Unscrew tip and guard assembly from gun.



11. Uncoil hose and connect one end to gun. Use two wrenches to tighten securely.



12. Connect other end of hose to sprayer. Use two wrenches to tighten securely.



 If hose is already connected, make sure connections are tight.

## Priming and Flushing Storage Fluid (Direct Immersion Method)

Before you use your sprayer for the first time or begin a new spraying project, you need to prime the sprayer and flush the storage fluid out of the sprayer.

### Oil- or Water-based Materials

- When spraying **water-based** materials, flush the system thoroughly with water.
- When spraying **oil-based** materials, flush the system thoroughly with mineral spirits or compatible, oil-based flushing solvent.
- To spray **water-based** materials **after spraying oil-based** materials, flush the system thoroughly with water first. The water flowing out of prime tube should be clear and solvent-free **before** you begin spraying the water-based material.
- To spray **oil-based** materials **after spraying water-based** materials, flush the system thoroughly with mineral spirits or a compatible oil-based flushing solvent first. The solvent flowing out of the prime tube should not contain any water.
- When flushing with solvents, ground gun. Read Grounding and Electric Requirements, page 4.
- To avoid fluid splashing back on your skin or into your eyes, always aim gun at inside wall of pail.

1. Verify AllControl is set to OFF and sprayer is unplugged.



2. Place prime tube in waste pail.



3. Submerge suction tube in flushing solvent.

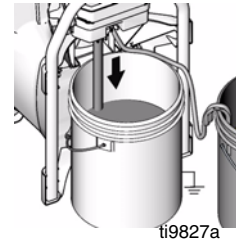

4. Plug sprayer in grounded outlet.

5. Set AllControl™ to PRIME/CLEAN PUMP.



6. When sprayer starts pumping, flushing solvent and air bubbles will be purged from system. Allow fluid to pump out of prime tube, into waste pail, for 30 to 60 seconds.

7. Turn AllControl to OFF.



8. Transfer suction tube to paint pail and submerge in paint.

9. Turn AllControl to PRIME/CLEAN PUMP.



10. When paint is pumping out of prime tube:

- a. point gun into waste pail.
- b. unlock gun trigger lock.
- c. pull and hold gun trigger.

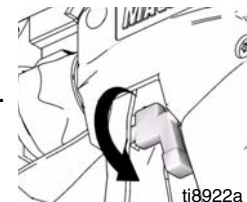

- d. set AllControl to PRIME/CLEAN GUN & HOSE.



11. Continue to trigger into waste pail until you see only paint coming out of gun.

12. Release trigger. Engage trigger lock.

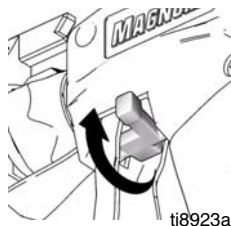

13. Transfer drain tube to paint pail and clip prime tube to suction tube.



- Motor stopping indicates pump and hose are primed with paint.
- If motor continues to run the sprayer is not properly primed. To reprime repeat step 6.

14. If spraying, install tip and guard on gun, page 13 and see Spraying Techniques, page 14.

If rolling, roller setup and Rolling Techniques, begin on page 18.

## Install Tip and Guard

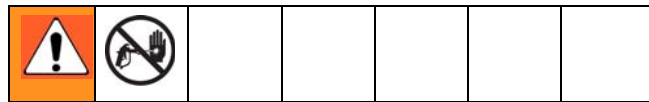

1. Engage trigger lock.

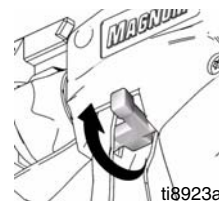

2. Verify tip and guard parts are assembled in order as shown below.

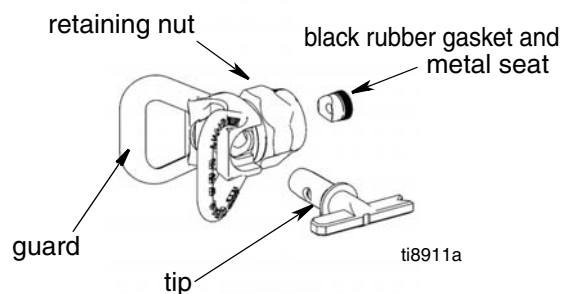

Use tip to align seat in guard.

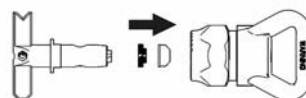

Tip must be pushed all the way into guard

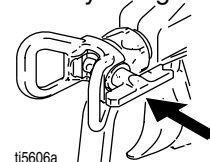

3. Screw tip and guard assembly on gun. Tighten retaining nut.

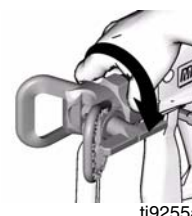



## Spraying Techniques

### Preventing Excessive Tip Wear

- Spray should be atomized (evenly distributed, no gaps at edges). Start at low pressure setting, increase pressure a little at a time until you see a good spray pattern, without tails.
- Spray at lowest pressure that atomizes paint.
- If maximum sprayer pressure is not enough for a good spray pattern, tip is too worn. See Reversible Spray Tip Selection Chart, page 16.

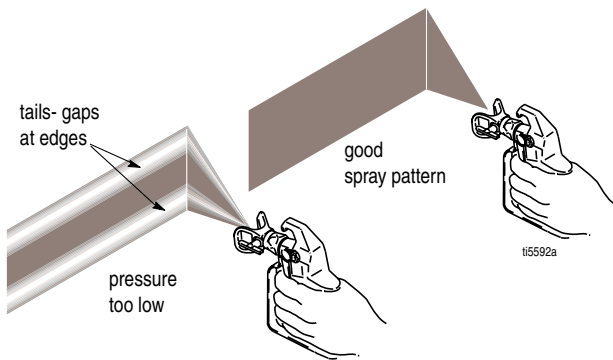

If tails persist when spraying at the highest pressure, a smaller tip is needed or the material may need to be thinned.

## Adjusting Pressure

Align setting indicator on AllControl with function, page 8.

- LOW SPRAY provides the lowest pressure for spraying.
- HIGH SPRAY increases pressure.

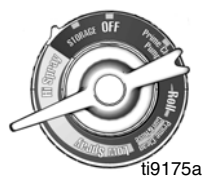

## Unclogging Spray Tip

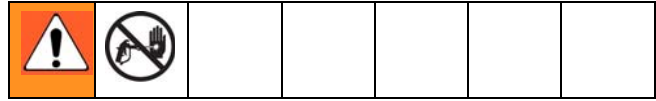

To avoid fluid splashback:

- Tip must be pushed all the way into guard.
- Never pull gun trigger when arrow-shaped handle is between SPRAY and UNCLOG positions.

1. To UNCLOG tip obstruction, engage trigger lock.



2. Point arrow-shaped handle backward to UNCLOG position.

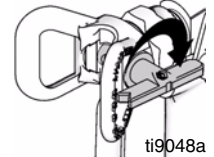

3. Aim gun at piece of scrap or cardboard.

4. Unlock trigger lock. Pull trigger to clear clog.



5. When obstruction is cleared, lock trigger lock and rotate arrow-shaped handle back to SPRAY position.

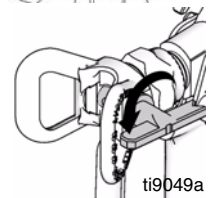

Point the arrow-shaped handle on the spray tip forward to SPRAY and backward to UNCLOG obstructions.



## Choosing the Correct Tip for the Job

Consider coating and surface to be sprayed. Make sure you use best tip hole size for that coating and best fan width for that surface.

### Tip Selection

#### Selecting Tip Hole Size

- Tip hole size controls flow rate - the amount of paint that comes out of the gun.
  - Tips come in a variety of hole sizes for spraying a range of fluids. Your sprayer includes an 0.015 in (0.38 mm) tip for use in most spraying applications. Use the following table to determine the range of recommended tip hole sizes for each fluid type. If you need a tip other than the one supplied, see the Reversible Tip Selection Chart on page 16.
- HINTS:**
- Use larger tip hole sizes with thicker coatings and smaller tip hole sizes with thinner coatings.
  - Maximum tip hole sizes supported by sprayer is 0.015 in. (0.38 mm).
- HINTS:**
- As you spray, the tip wears and enlarges. Starting with a tip hole size smaller than the maximum will allow you to spray within the rated flow capacity of the sprayer.
  - Maximum tip hole sizes supported by sprayer is 0.015 in. (0.38 mm).

Tip Hole Size	Coatings				
	<i>Stains</i>	<i>Enamels</i>	<i>Primers</i>	<i>Interior paints</i>	<i>Exterior paints</i>
0.011 in. (0.28 mm)	✓				
0.013 in. (0.33 mm)	✓	✓	✓	✓	
0.015 in. (0.38 mm)		✓	✓	✓	✓

#### Fan Width

Fan width is the size of the spray pattern, which determines the area covered with each stroke. Narrower fans deliver a thicker coat, and wider fans deliver a thinner coat.

**HINTS:**

- Select a fan width best suited to the surface being sprayed.
- Wider fans allow provide better coverage on broad, open surfaces.
- Narrower fans provide better control on small, confined surfaces.

## Understanding Tip Number

The last three digits of tip number (i.e.: 221413) contain information about hole size and fan width on surface when gun is held 12 in. (30.5 cm) from surface being sprayed.

First digit when doubled  
= approximate  
fan width

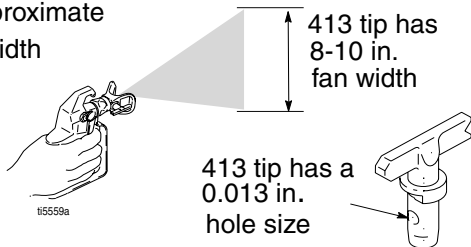

Last two digits = tip hole size in thousands of an inch

## Reversible Tip Selection Chart

Tip Part No.	Fan Width 12 in. (305 mm) from surface	Hole Size
221311	6 - 8 in. (152 - 203 mm)	0.011 in. (0.28 mm)
221411	8 - 10 in. (203 - 254 mm)	0.011 in. (0.28 mm)
221313	6 - 8 in. (152 - 203 mm)	0.013 in. (0.33 mm)
221413	8 - 10 in. (203 - 254 mm)	0.013 in. (0.33 mm)
221415	8 - 10 in. (203 - 254 mm)	0.015 in. (0.38 mm)
221515	10 - 12 in. (254 - 305 mm)	0.015 in. (0.38 mm)

**Example:** For an 8 to 10 in. (203 to 254 mm) fan width and 0.013 (0.33 mm) hole size, order Part No. 221413.

# Getting Started With Basic Techniques

Use the Practice Spray Board to practice these basic spraying techniques before you begin spraying the surface.

- Hold gun 12 in. (30 cm) from surface and aim straight at surface. Tilting gun to direct spray angle causes an uneven finish.

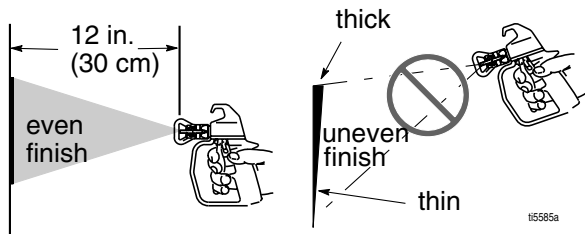

- Flex wrist to keep gun pointed straight. Fanning gun to direct spray at angle causes uneven finish.

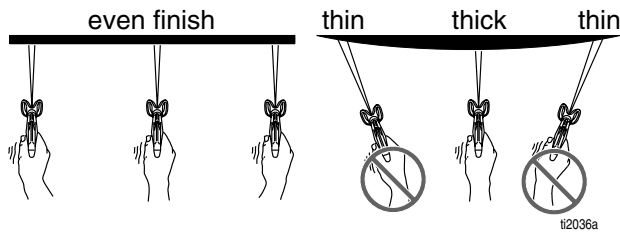

## Triggering Gun

Pull trigger after starting stroke. Release trigger before end of stroke. Gun must be moving when trigger is pulled and released.

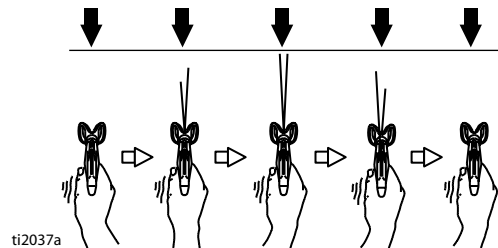

## Aiming Gun

Aim tip of gun at bottom edge of previous stroke, overlapping each stroke by half.

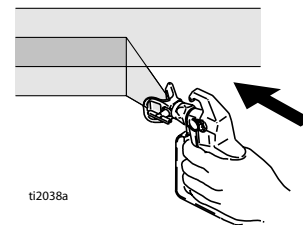

# Rolling

## Setup

- Before assembling roller, follow Priming instructions, beginning on page 9 for Hopper Method or page 12 for Immersion Method.
- After priming, only paint should come out of spray gun. Water in hose line will cause paint to run.

1. Set AllControl to lowest ROLL setting.

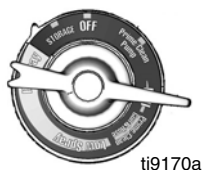

2. If installed, remove tip and guard assembly from gun.

3. Make sure gasket is in place in bottom of roller frame.

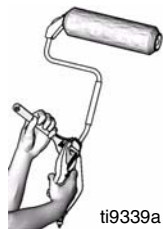

4. Rest roller on flat surface and align gun with roller. Tighten nut with wrench while keeping gun and roller aligned.

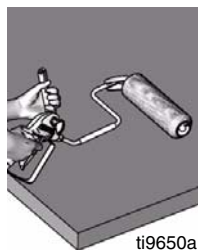

5. Unlock gun trigger safety. Trigger gun. Roll surface until paint is fully dispersed on roller. This may take a minute.



- Trigger gun briefly only when you need more paint.
- For best operating pressure set AllControl to the lowest ROLLER setting which provides an even paint supply to the roller.

6. Increase pressure only if triggering gun does not supply enough paint for your rolling speed.

7. Whenever you stop painting, **relieve pressure**, page 7 and elevate roller end of extension tube to prevent paint from draining out.

8. Flush the pump, gun and pressure roller immediately after each use to prevent paint from drying in the pressure roller and damaging it. See Shutdown and Cleaning, beginning on page 20.

## Rolling Techniques

1. Rolling vertically, roll out the letter "M".

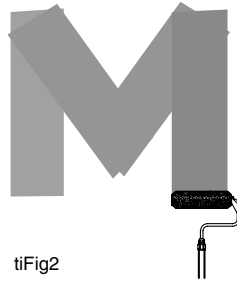

2. Cross roll, horizontally, to spread paint.

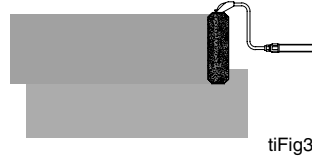

3. Finish with light, vertical strokes until the entire area has been covered evenly.

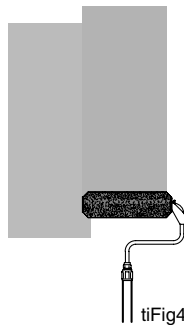

## Ceilings, Walls and Woodwork

1. **Ceilings:** Using a paint brush, apply a starting row of paint approximately the width of your paint brush where the walls and ceiling meet.

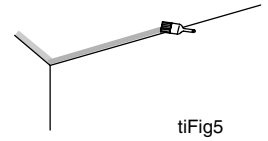

2. With the roller apply paint to the ceiling, working the short way of the room and applying as wide a strip as possible.

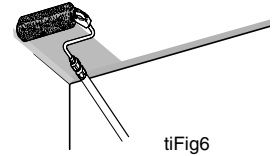

1. **Walls and Woodwork:** Using a brush, paint woodwork first. Apply a starting row of paint approximately the width of the paint brush around the woodwork and where the walls meet the ceiling.

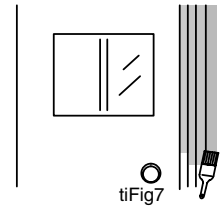

2. With the roller, apply paint to the walls, following the Rolling Techniques on page 19.

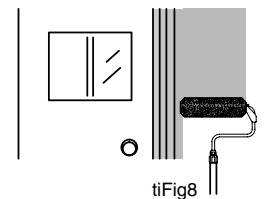

# Shutdown & Cleaning - After Hopper Method Applications

- For short term shutdown periods (overnight to one week) refer to Short Term Storage, page 29.
- For flushing after spraying oil-based coatings, use compatible oil-based flushing fluid or mineral spirits.
- For flushing after spraying water-based coatings, use water.
- If you are using water-based materials, you have the option of following the cleanup procedure described below, or for faster cleanup, Power Flush, starting on page 22.

1. **Relieve pressure**, page 7.
2. If you used a spray gun, remove tip and guard assembly from gun and place in flushing fluid.

If you used a roller, leave roller assembly attached to gun.

3. Pour unused paint out of hopper and back into original container.

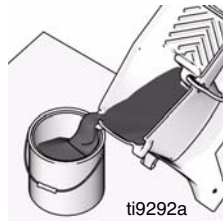

4. Place drain tube in waste pail.

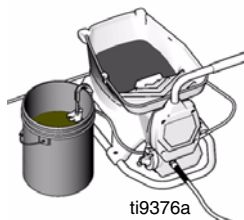

5. Use inlet screen handle to remove inlet screen from hopper. Place it in a bucket of clean water or cleaning solvent.

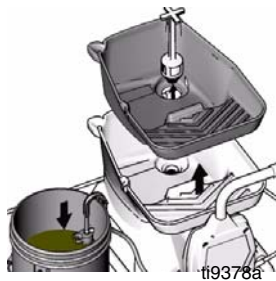

6. Turn AllControl to PRIME/CLEAN PUMP to remove excess paint in hopper.



7. If you used a liner, carefully remove liner from hopper and dispose of it in a proper trash container.

8. Fill a bucket with water or cleaning solvent and pour it into hopper.

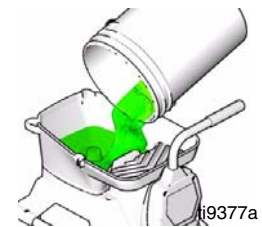

9. Plug sprayer in grounded outlet.

10. Set AllControl to PRIME/CLEAN PUMP. Circulate fluid for at least a minute.



11. Turn AllControl to OFF.

12.
  - a. If you used a spray gun only, continue with Step 11.



- b. If you used a roller follow Cleaning Roller instructions beginning on page 28.

 Step 13 is for returning paint in hose back to paint pail. One 25-ft (7.5 m) hose holds approximately 1-pint (1.5-liter) of paint.



13. To preserve paint in hose:

- a. Add enough water or cleaning solvent to refill hopper. Point gun into paint pail.

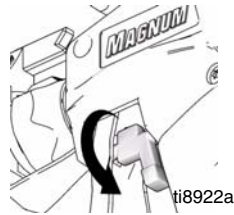

- b. Unlock gun trigger lock.
- c. Pull and hold gun trigger.



- d. Turn AllControl to PRIME/CLEAN GUN & HOSE.

Continue to hold gun trigger until you see paint diluted with flushing fluid starting to come out of gun.

14. While continuing to trigger gun, quickly move gun to redirect spray into waste pail. Continue triggering gun into waste pail until flushing fluid dispensed from gun is relatively clear and all the flushing fluid has drained from hopper.



15. Stop triggering gun. Engage trigger lock.



16. Turn AllControl to OFF.



17. Follow Long Term Storage instructions, page 29.

18. Clip drain tube to hopper.

19. Use a soft brush to clean paint and debris off strainer. Install strainer in hopper.

20. Clean gun fluid filter (d) with water or flushing solvent and a brush every time you flush the system. Replace gun filter if damaged.

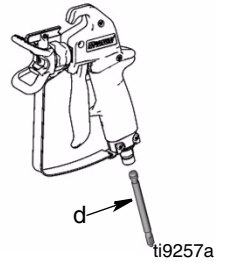

21. Clean tip and guard with water or flushing solvent. A soft brush can be used to loosen and remove dried material if needed.



22. Use a soft cloth to wipe off hopper, cover, and hose. Install hopper cover.

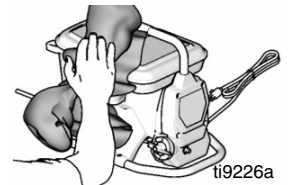

**CAUTION**

Do not immerse hopper. Water or cleaning solvents will damage the internal sprayer components.

## Power Flush

Power flushing is a faster method of flushing. It can only be used after spraying water-based coatings.

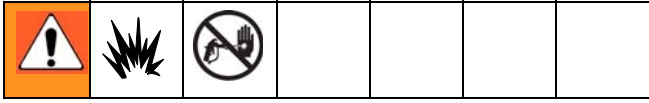

1. **Relieve pressure**, page 7.
2. If you used a spray gun, remove tip and guard assembly from gun and place in flushing fluid.

If you used a roller, leave roller assembly attached to gun.

3. Pour unused paint out of hopper and back into original container.

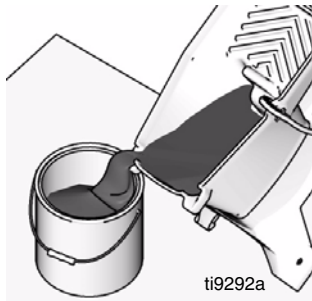

4. Place drain tube in waste pail.

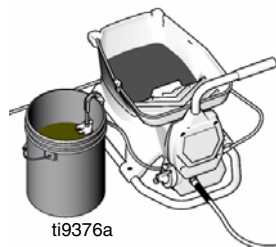

5. Use inlet screen handle to remove inlet screen from hopper. Place in bucket of clean water or cleaning solvent.



6. Turn AllControl to **PRIME/CLEAN PUMP** to remove excess paint in hopper.



7. If you used a liner, carefully remove liner from hopper and dispose of liner in a proper trash container.

8. Screw power flush attachment to garden hose.



9. Thread hose extender into hopper inlet.

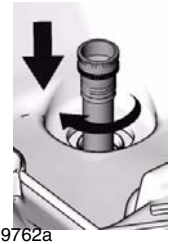

10. Connect Power Flush attachment to hose extender.

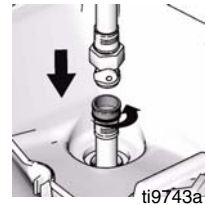

11. Turn water on and open valve.

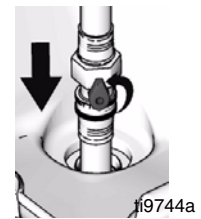

12. Turn AllControl to **PRIME/CLEAN PUMP**. Let water flow out of drain tube, into waste pail for 30 seconds.



13. Turn AllControl to **OFF**.

- 14.

- a. If you used a spray gun only, continue with Step 14.



- b. If you used a roller follow Cleaning Roller instructions beginning on page 28.

 Step 15 is for returning paint in hose back to paint pail. One 25-ft (7.5-m) hose holds approximately 1-pint (0.5-liter) of paint.

15. To preserve paint in hose:
  - a. Point gun into paint pail.
  - b. Unlock gun trigger lock.



- c. Pull and hold gun trigger.

- d. Turn AllControl to PRIME/CLEAN GUN AND HOSE.



- e. Continue to hold gun trigger until you see paint, diluted with water starting to come out of gun.

16. While continuing to trigger gun, quickly move gun to redirect spray into waste pail. Continue triggering gun into waste pail until water coming out of gun is relatively clear, approximately 1-2 minutes.



17. Stop triggering gun. Engage trigger lock.



18. Set AllControl™ to OFF.



19. Close Power Flush attachment.

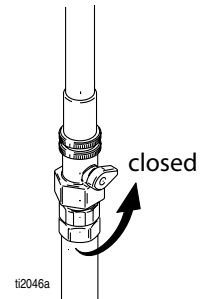

20. Remove hose extender and Power Flush attachment from hopper.

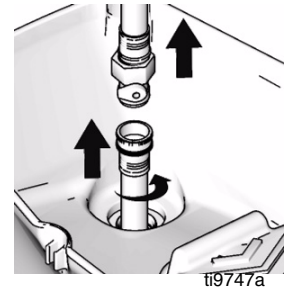

21. Follow Long Term Storage instructions, page 29.

22. Clip drain tube to hopper.

23. Use a soft brush to clean paint and debris off strainer and install strainer in hopper.

24. Clean gun fluid filter (d) with water or flushing solvent and a brush every time you flush the system. Replace gun filter if damaged.

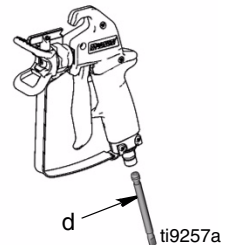

25. Clean tip and guard with water or flushing solvent. A soft brush can be used to loosen and remove dried on material if needed.



26. Wipe paint off outside of gun using a soft cloth moistened with water or flushing solvent.

27. Use a soft cloth to wipe off hopper, cover, and hose. Install hopper cover.

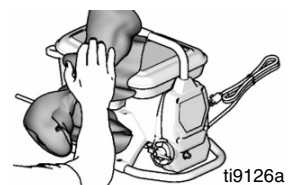

# Shutdown & Cleaning - After Direct Immersion Method Applications

## Pail Flushing

-  For short term shutdown periods (overnight to one week) refer to Short Term Storage, page 29.
- For flushing after spraying oil-based coatings, use compatible oil-based flushing fluid or mineral spirits.
- For flushing after spraying water-based coatings, use water.
- If you are using water-based materials, you have the option of following the cleanup procedure described below, or for faster cleanup, Power Flush, starting on page 26.

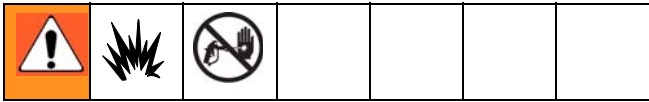

1. **Relieve pressure**, page 7.
2. If you used a spray gun, remove tip and guard assembly from gun and place in flushing fluid.

If you used a roller, leave roller assembly attached to gun.

3. Lift suction tube and prime tube from paint pail. Let them drain into paint for a while.

4. Separate prime tube (smaller) from suction tube (larger).

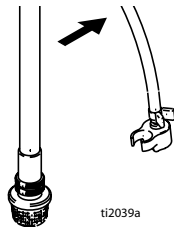

ti2039a

5. Place waste and paint pail side by side.



ti9726a

6. Submerge suction tube in water or flushing solvent.

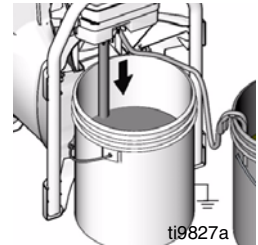

ti9827a

7. Place prime tube in waste pail.

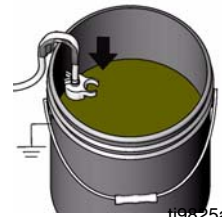

ti9825a

8. Set AllControl to PRIME/CLEAN PUMP.



ti9169a

9. Flush until approximately 1/3 of the flushing fluid is emptied from the pail.

10. Turn AllControl to OFF.



ti9168a

11.
  - a. If you used a spray gun only, continue Pail Flushing, Step 12.
  - b. If you used a roller follow Cleaning Roller instructions beginning on page 28.

Step 12 is for returning paint in hose back to paint pail. One 25-ft (7.5 m) hose holds approximately 1-pint (0.5-liter) of paint.

12. To preserve paint in hose:

a. Point gun into paint pail.

b. Unlock gun trigger lock.

c. Pull and hold gun trigger.

d. Turn AllControl to PRIME/CLEAN GUN & HOSE.

Continue to hold gun trigger until you see paint diluted with flushing fluid starting to come out of gun.

13. While continuing to trigger gun, quickly move gun to redirect spray into waste pail. Continue triggering gun into waste pail until flushing fluid dispensed from gun is relatively clear.

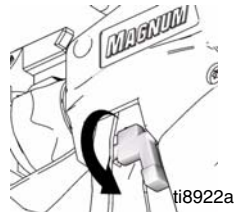

ti8922a



ti9171a



ti9745a

14. Stop triggering gun. Engage trigger lock.



ti8923a

15. Turn AllControl to OFF.



ti9168a

16. Follow Long Term Storage instructions, page 29.

17. Clip drain tube to hopper.

18. Use a soft brush to clean paint and debris off strainer. Install strainer in hopper.

19. Clean gun fluid filter (d) with water or flushing solvent and a brush every time you flush the system. Replace gun filter if damaged.

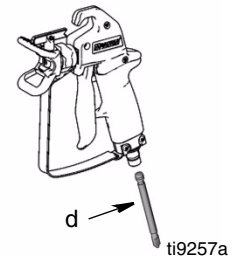

ti9257a

20. Clean tip and guard with water or flushing solvent. A soft brush can be used to loosen and remove dried on material if needed.



ti9671a

21. Wipe paint off outside of gun using a soft cloth moistened with water or flushing solvent.

22. Use a soft cloth to wipe off hopper, cover, and hose.



## Power Flush

Power flushing is a faster method of flushing. It can only be used after spraying water-based coatings.

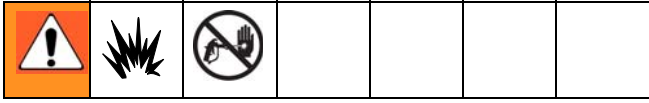

1. **Relieve pressure**, page 7.
2. If you used a spray gun, remove tip and guard assembly from gun and place in flushing fluid.

If you used a roller, leave roller assembly attached to gun.

3. Place waste and paint pails side by side.



4. Lift suction tube and prime tube from paint pail. Let them drain into paint for a while.
5. Place suction and prime tubes in waste pail.

6. Screw power flush attachment to garden hose. Close valve.

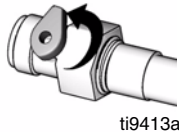

7. Turn on water. Open valve. Rinse paint off suction tube, prime tube and inlet screen.



8. Turn lever to close power flush attachment.

9. Unscrew inlet screen from suction tube. Place inlet screen in waste pail.

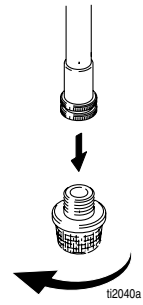

10. Connect suction tube to Power Flush attachment. Leave prime tube in waste pail.

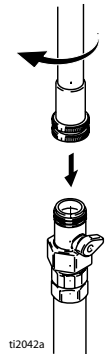

11. Open lever on Power Flush attachment.

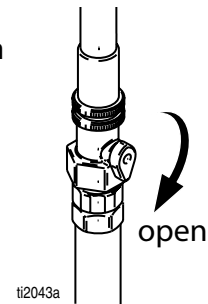

12. Turn AllControl to PRIME/CLEAN PUMP.



13. Circulate water through sprayer, into waste pail for 20 seconds.

14. Turn AllControl to OFF.





 Step 15 is for returning paint in hose back to paint pail. One 25-ft (7.5-m) hose holds approximately 1-pint (0.5-liter) of paint.

15. To preserve paint in hose:

a. Point gun into paint pail.

b. Unlock gun trigger lock.



c. Pull and hold gun trigger.

d. Turn AllControl to PRIME/CLEAN GUN & HOSE.



e. Continue to hold gun trigger until you see paint diluted with water starting to come out of gun.

16. While continuing to trigger gun, quickly move gun to redirect spray into waste pail. Continue triggering gun into waste pail until water coming out of gun is relatively clear.



17. Stop triggering gun. Engage trigger lock.



18. Turn AllControl to OFF.



19. Turn off garden hose. Close Power Flush attachment.

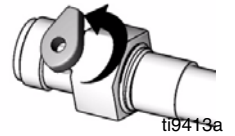

20. Unscrew Power Flush attachment from suction tube.

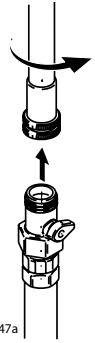

21. Use a soft brush to clean paint and debris off strainer and install strainer in hopper.

22. Follow Long Term Storage instructions, page 29.

23. Clean gun fluid filter (d) with water or flushing solvent and a brush every time you flush the system. Replace gun filter if damaged.

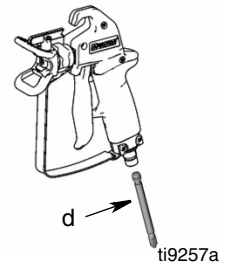

24. Clean tip and guard with water or flushing solvent. A soft brush can be used to loosen and remove dried on material if needed.



25. Wipe paint off outside of gun using a soft cloth moistened with water or flushing solvent.

26. Use a soft cloth to wipe off hopper, cover and hose.

## Cleaning Roller



1. **Relieve Pressure**, page 7.
2. Remove roller cover (a) and core (b) from roller frame (c) as follows:
  - a. Using your thumb, press clip (d) to release roller.
  - b. Remove cap (e) from core (b). It may be necessary to use a screwdriver to remove cap from core.
  - c. Remove roller cover (a) from core (b).
3. Clean roller cover, cap and core with water or for oil-based materials, a compatible cleaning solvent.

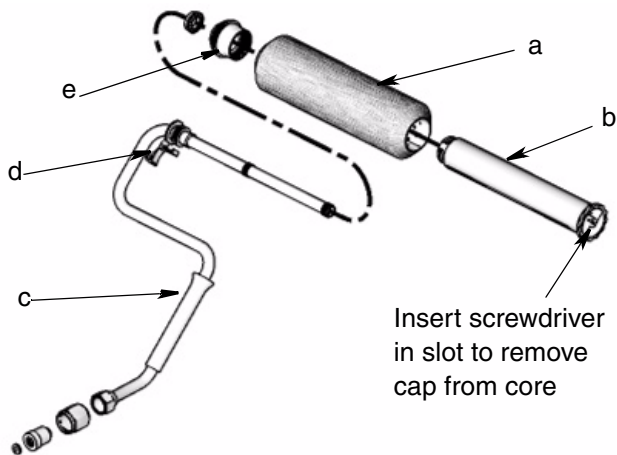

4. Place roller frame in paint pail. Be sure holes in roller frame are facing inside paint pail.

 Step 5 is for returning paint in hose back to paint pail.

5.
  - a. Turn AllControl to the LOW Spray range on the dial to begin pumping paint in hose back into paint pail.
  - b. When water or cleaning solvent comes out of roller frame, release trigger.
6. Move roller frame to waste pail. Trigger gun to flush hose, roller frame and gun into waste pail.
7. Continue until remaining flushing fluid is gone from hopper. If necessary, add additional water or flushing solvent to hopper to sufficiently clean hose, roller frame and gun.
8. Stop triggering gun. Engage trigger lock.



9. Follow Long Term Storage instructions, page 29.

10. Clean gun fluid filter (d) with water or flushing solvent and a brush every time you flush the system. Replace gun filter if damaged.

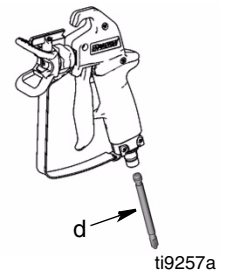

11. Wipe paint off outside of gun and roller frame using a soft cloth moistened with water or flushing solvent.

# Storage

## Short Term Storage

(up to 2 days)

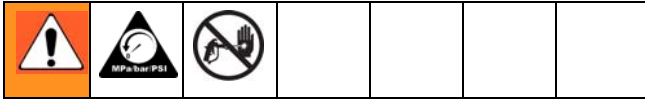

1. Turn AllControl to OFF. Pause 2-3 seconds to allow pressure to be relieved, then turn to STORAGE.



Pause  
2-3 Seconds



2. Engage trigger lock.

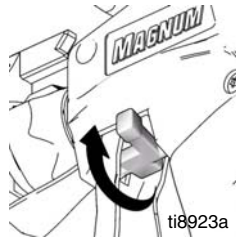

3. Leave gun attached to hose.

4. Remove tip and guard and clean with water or flushing solvent. A soft brush can be used to loosen and remove dried on material if needed.



5. Wipe paint off outside of gun using a soft cloth moistened with water or flushing solvent.

## Long Term Storage

(more than 2 days)

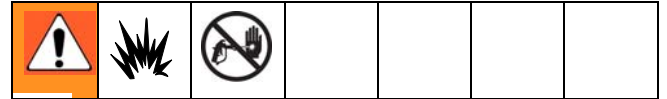

- Always circulate Pump Armor storage fluid through system after cleaning. Water left in sprayer will corrode and ruin pump.
- Follow Shutdown and Cleaning instructions starting on page 20 or 23.

1. **HOPPER METHOD:** Place prime tube in waste pail. Pour 8 oz. of Pump Armor into hopper.

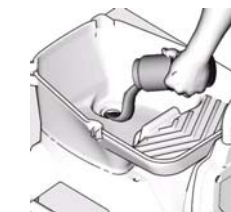

Hopper Method

OR

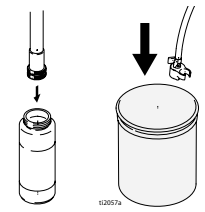

Immersion Method

2. Set AllControl to PRIME/CLEAN PUMP.



3. When storage fluid comes out of prime tube (5-10 seconds) turn AllControl to OFF.



4. Wait 2-3 seconds to allow pressure to be relieved, then turn AllControl to STORAGE.



# Stowing Sprayer

-  Be sure to turn AllControl to OFF and pause 2 - 3 seconds before turning to STORAGE to relieve pressure in the system.

## CAUTION

- Before storing sprayer make sure all water is drained out of sprayer and hoses.
- Do not allow water to freeze in sprayer or hose.
- Do not store sprayer under pressure.

1. Use inlet screen handle to install inlet screen into hopper.



2. Coil hose and leave it connected to sprayer.

3. If not already secured to hopper, clip prime tube to side of hopper.

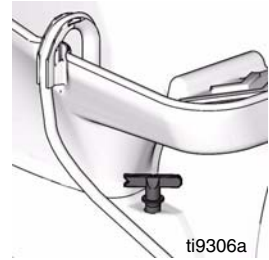

4. Replace cover on hopper and return handle to normal position.

NOTE: Handle does not lock cover down.

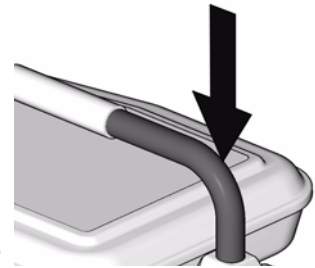

5. Store sprayer indoors.

# Troubleshooting

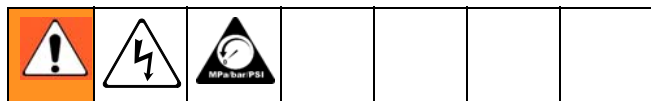

Check everything in this Troubleshooting Table before you bring the sprayer to a Graco/MAGNUM authorized service center.

Problem	Cause	Solution
Power is on and sprayer is plugged in, but motor does not run, and pump does not cycle.	AllControl is set at zero pressure.	Turn AllControl clockwise to increase pressure setting.
	Motor or control is damaged.	Take sprayer to Graco/MAGNUM authorized service center.
	Electric outlet is not providing power.	<ul style="list-style-type: none"> <li>Try a different outlet or plug in something that you know is working to test outlet.</li> <li>Reset building circuit breaker or replace fuse.</li> </ul>
	Extension cord is damaged.	Replace extension cord. Read Grounding and Electric Requirements, page 4.
	Sprayer electric cord is damaged.	Check for broken insulation or wires. Replace electric cord if damaged.
	Paint is frozen or hardened in pump.	<p>Unplug sprayer from outlet. If frozen do NOT try to start sprayer until it is completely thawed or you may damage the motor, control board and/or drivetrain.</p> <p>Make sure AllControl is OFF. Place sprayer in a warm area for several hours. Then plug in and turn AllControl to Prime/Clean to see if motor will start.</p> <p>If paint is hardened in sprayer, pump packings, valves, drivetrain or pressure switch may need to be replaced. Take sprayer to Graco/MAGNUM authorized service center.</p>
	System is already pressurized.	Turn AllControl to OFF, pause 2-3 seconds and then turn AllControl to STORAGE to relieve pressure.
Pump does not prime.	AllControl not set to correct function.	Turn AllControl to PRIME/CLEAN PRIME position.
	Inlet screen is clogged.	Clean debris off inlet screen.
	Pump valve check balls or seat are dirty.	Remove fittings. Clean or replace ball and seat.

<b>Problem</b>	<b>Cause</b>	<b>Solution</b>
Pump does not prime.	In Immersion Mode suction tube is not immersed	Make sure suction tube is immersed in paint.
	Suction tube is leaking.	Tighten suction tube connection. Inspect for cracks or vacuum leaks.
	Pump does not prime with fluid.	Remove suction tube from paint. Prime pump with water or solvent-based flushing fluid.
Spray gun stopped spraying.	Spray tip is clogged.	Unclog spray tip, page 14.
Pump cycles but does not build up pressure.	Pump is not primed.	Prime pump.
	Inlet screen is clogged.	Clean debris off inlet screen.
	In Immersion Mode suction tube is not immersed in paint.	Make sure suction tube is immersed in paint.
	Hopper or paint pail is empty.	Refill hopper or paint pail. Reprime sprayer.
	Suction tube is leaking.	Tighten suction tube connection. Inspect for cracks or vacuum leaks. If cracked or damaged, replace suction tube.
Pump cycles, but paint only dribbles or spurts when spray gun is triggered.	Pressure is set too low.	Slowly turn AllControl to Hi Spray to increase pressure setting.
	Spray tip is clogged.	Unclog spray tip, page 14.
	Spray gun fluid filter is clogged.	Clean or replace gun fluid filter.
	Spray tip is too large or worn.	Replace tip.
Spray pattern is inconsistent or is leaving stripes.	Pressure is set too low.	Slowly turn AllControl to HI SPRAY to increase pressure setting.
	Spray tip is worn beyond capability of sprayer.	Replace spray tip.
	Paint is too thick.	Thin paint slightly with compatible solvent or water.
Pressure is set at maximum but cannot achieve a good spray pattern.	Spray tip is too large for sprayer.	Select smaller spray tip.
	Spray tip is worn beyond capability of sprayer.	Replace spray tip.
	Extension cord is too long or not heavy enough gauge.	Replace extension cord. Grounding and Electrical Requirements, page 4.
	Spray gun fluid filter is clogged.	Clean or replace spray gun fluid filter.
	Inlet screen is clogged.	Clean debris off inlet screen.
When paint is sprayed, it runs down the wall or sags.	Coat is going on too thick.	Move gun faster.
		Choose a tip with smaller hole size.
		Choose tip with wider fan.
		Make sure gun is far enough from surface.
When paint is sprayed, coat is not covering.	Coat is going on too thin.	Move gun slower.
		Choose tip with larger hole size.
		Choose tip with narrower fan.



Problem	Cause	Solution
When paint is sprayed, coat is not covering.	Coat is going on too thin.	Make sure gun is close enough to surface.
Motor is hot and runs intermittently. This is NOT a thermal overload condition. Motor automatically shuts off due to excessive heat. Damage can occur if cause is not corrected. <b>Thermal Overload</b> , page 4.	Vent holes in enclosure are plugged or sprayer is covered.	Keep vent holes clear of obstructions and overspray and keep sprayer open to air.
	Extension cord is too long or not a heavy enough gauge.	Replace extension cord. Read Grounding and Electrical Requirements, page 4.
	Unregulated electrical generator being used has excessive voltage.	Use electrical generator with a proper voltage regulator. Sprayer requires 120VAC, 60 Hz, 1500-Watt generator.
	Sprayer was operated at high pressure with very small tip which causes frequent motor starts and excessive heat build up.	Decrease pressure setting or increase tip size.
Building circuit breaker opens after sprayer operates for 5 to 10 minutes.	Too many appliances are plugged in on same circuit.	Free up circuit (unplug things), or use a less busy circuit.
	Sprayer electrical cord is damaged.	Check broken insulation or wires. Replace electrical cord if damaged.
	Extension cord is damaged or too long or not a heavy enough gauge.	<ul style="list-style-type: none"> <li>• Plug in something that you know is working to test extension cord.</li> <li>• Replace extension cord.</li> </ul>
Cannot trigger spray gun.	Spray gun trigger safety is locked.	Rotate trigger safety lever to unlock position, page 7.
Spray comes out of spray gun in two thick streams.	Reversible spray tip is in UNCLOG position.	Rotate arrow-shaped handle on spray tip so it points forward in SPRAY position, page 14.
Paint is coming out of from inside sprayer.	AllControl is worn.	Take sprayer to Graco/MAGNUM authorized service center.
Paint leaks down outside of sprayer.	Pump packings are worn.	Replace pump packings.

# Maintenance and Service

## CAUTION

**Protect the internal drive parts of this sprayer from water.** Openings in shroud allow cooling of mechanical parts and electronics inside. If water gets into these openings, the sprayer could malfunction or be permanently damaged.

## Caring for Sprayer

Keep sprayer and all accessories clean and in good working order.

To avoid overheating motor, keep vent holes in shroud clear for air flow.

Do not cover sprayer while spraying.

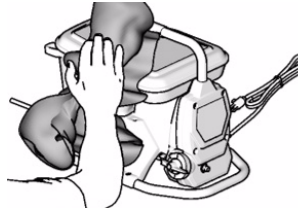

## Paint Hoses

Check hose for damage every time you spray. Do not attempt to repair hose if hose jacket or fittings are damaged. Wrench tighten, using two wrenches.

## Tips

- Always clean tips with compatible solvent and brush after spraying.
- Tips may require replacement after 15 gallons (57 liters) or they may last through 60 gallons (227 liters) depending on abrasiveness of paint.
- Do not spray with worn tip.

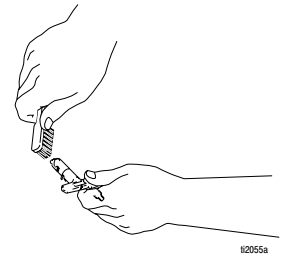

## Pump Packings

When pump packings wear, paint will begin to leak down outside of pump. Replace pump packings at first sign of leaking or additional damage could occur. Get a pump repair kit and install according to instruction on kit packaging. Consult a Graco/MAGNUM authorized service center.

## Technical Data

Working pressure range	0-2800 psi (0-19 MPa, 0 -193 bar)
Electric motor	6.3 AMP (open frame, universal)
Operating horsepower	3/8
Maximum delivery (with tip)	0.24 gpm (0.91 lpm)
Paint hose	1/4 in. x 25 ft (6.4 mm x 7.5 m)
Maximum tip hole size	0.015 in. (0.38 mm)
Weight:	
Sprayer only	20 lbs. (9.0 Kg)
Sprayer, hose & gun	23 lbs. (10.5 Kg)
Roller	1 lb. (0.5 Kg)
Dimensions:	
Length	22.5 in. (57 cm)
Width	14 in. (35.6 cm)
Height	16.5 in. (41.9 cm)
Power cord	18 AWG, 3-wire, 6 ft (1.8 m)
Fluid inlet fitting	3/4 in. internal thread (standard garden hose thread)
Fluid outlet fitting	1/4 NPSM external thread
Inlet screen	35 mesh (450 micron)
Wetted parts, pump & hose	stainless steel, brass, ultra-high molecular weight polyethylene (UHMWPE), carbide, nylon, aluminum, PVC, polypropylene, fluoroelastomer
Wetted parts, gun	SG10: plated steel, nylon, aluminum, tungsten carbide, stainless steel, brass, fluoroelastomer
Generator requirement	1500 Watt minimum
Electrical power requirement	120VAC, 60 Hz, 1 phase, 15A
Storage temperature range ♦❖	-30° to 160°F (-35° to 71°C)
Operating temperature range ✓	40° to 115°F (4° to 46°C)

- ♦ **When pump is stored with non-freezing fluid. Pump damage will occur if water or latex paint freezes in pump.**
- ❖ Damage to plastic parts may result if impact occurs in low temperature conditions.
- ✓ Changes in paint viscosity at very low or very high temperatures can affect sprayer performance.

# Graco Standard Warranty

Graco warrants all equipment referenced in this document which is manufactured by Graco and bearing its name to be free from defects in material and workmanship on the date of sale to the original purchaser for use. With the exception of any special, extended, or limited warranty published by Graco, Graco will, for a period of twelve months from the date of sale, repair or replace any part of the equipment determined by Graco to be defective. This warranty applies only when the equipment is installed, operated and maintained in accordance with Graco's written recommendations.

This warranty does not cover, and Graco shall not be liable for general wear and tear, or any malfunction, damage or wear caused by faulty installation, misapplication, abrasion, corrosion, inadequate or improper maintenance, negligence, accident, tampering, or substitution of non-Graco component parts. Nor shall Graco be liable for malfunction, damage or wear caused by the incompatibility of Graco equipment with structures, accessories, equipment or materials not supplied by Graco, or the improper design, manufacture, installation, operation or maintenance of structures, accessories, equipment or materials not supplied by Graco.

This warranty is conditioned upon the prepaid return of the equipment claimed to be defective to an authorized Graco distributor for verification of the claimed defect. If the claimed defect is verified, Graco will repair or replace free of charge any defective parts. The equipment will be returned to the original purchaser transportation prepaid. If inspection of the equipment does not disclose any defect in material or workmanship, repairs will be made at a reasonable charge, which charges may include the costs of parts, labor, and transportation.

**THIS WARRANTY IS EXCLUSIVE, AND IS IN LIEU OF ANY OTHER WARRANTIES, EXPRESS OR IMPLIED, INCLUDING BUT NOT LIMITED TO WARRANTY OF MERCHANTABILITY OR WARRANTY OF FITNESS FOR A PARTICULAR PURPOSE.**

Graco's sole obligation and buyer's sole remedy for any breach of warranty shall be as set forth above. The buyer agrees that no other remedy (including, but not limited to, incidental or consequential damages for lost profits, lost sales, injury to person or property, or any other incidental or consequential loss) shall be available. Any action for breach of warranty must be brought within two (2) years of the date of sale.

**GRACO MAKES NO WARRANTY, AND DISCLAIMS ALL IMPLIED WARRANTIES OF MERCHANTABILITY AND FITNESS FOR A PARTICULAR PURPOSE, IN CONNECTION WITH ACCESSORIES, EQUIPMENT, MATERIALS OR COMPONENTS SOLD BUT NOT MANUFACTURED BY GRACO.** These items sold, but not manufactured by Graco (such as electric motors, switches, hose, etc.), are subject to the warranty, if any, of their manufacturer. Graco will provide purchaser with reasonable assistance in making any claim for breach of these warranties.

In no event will Graco be liable for indirect, incidental, special or consequential damages resulting from Graco supplying equipment hereunder, or the furnishing, performance, or use of any products or other goods sold hereto, whether due to a breach of contract, breach of warranty, the negligence of Graco, or otherwise.

## **FOR GRACO CANADA CUSTOMERS**

The Parties acknowledge that they have required that the present document, as well as all documents, notices and legal proceedings entered into, given or instituted pursuant hereto or relating directly or indirectly hereto, be drawn up in English. Les parties reconnaissent avoir convenu que la rédaction du présente document sera en Anglais, ainsi que tous documents, avis et procédures judiciaires exécutés, donnés ou intentés, à la suite de ou en rapport, directement ou indirectement, avec les procédures concernées.

**TO PLACE AN ORDER** or to identify the nearest Graco/MAGNUM distributor, contact us at  
1-888-541-9788

*All written and visual data contained in this document reflects the latest product information available at the time of publication. Graco reserves the right to make changes at any time without notice.*

MM 312079

**Graco Headquarters: Minneapolis**  
**International Offices: Belgium, China, Japan, Korea**  
**GRACO INC. P.O. BOX 1441 MINNEAPOLIS, MN 55440-1441**  
www.graco.com  
3/2007