

Reactor[®] 2 E-30 and E-XP2 Proportioning System

333023V

EN

Electric, heated, plural component proportioning system. For spraying polyurethane foam and polyurea coatings. For professional use only. Not approved for use in explosive atmospheres or hazardous (classified) locations.



Important Safety Instructions

Read all warnings and instructions in this manual before using the equipment.
Save these instructions.

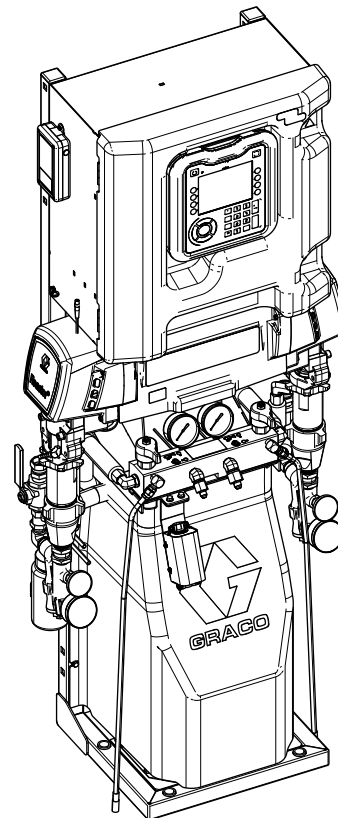







ti20577b

Contents

Warnings	3	Startup	43
Important Isocyanate Information	6	Fluid Circulation	46
Isocyanate Conditions	6	Circulation Through Reactor	46
Material Self-Ignition	7	Circulation Through Gun Manifold	47
Keep Components A and B Separate	7	Jog Mode	47
Change Material	7	Spraying	48
Moisture Sensitivity of Isocyanates	7	Spray Adjustments	49
Foam Resins with 245 fa Blowing Agents	7	Hose Control Modes	50
Models	8	Enable Hose Resistance Mode	51
Reactor 2 E-30 and E-30 Elite	8	Disable Hose Resistance Mode	52
Reactor 2 E-XP2 and E-XP2 Elite	9	Enable Hose Manual Mode	52
Approvals	10	Disable Hose Manual Mode	53
Accessories	10	Calibration Procedure	54
Supplied Manuals	11	Shutdown	55
Related Manuals	11	Purge Air Procedure	57
Typical Installation, without circulation	12	Pressure Relief Procedure	59
Typical Installation, with system fluid manifold to drum circulation	13	Flushing	60
Typical Installation, with gun fluid manifold to drum circulation	14	Maintenance	61
Component Identification	15	Preventative Maintenance Schedule	61
Advanced Display Module (ADM)	17	Proportioner Maintenance	61
ADM Display Details	19	Flush Inlet Strainer Screen	62
Electrical Enclosure	22	Pump Lubrication System	63
Motor Control Module (MCM)	23	Errors	64
Temperature Control Module (TCM) Cable Connections	24	View Errors	64
Installation	25	Troubleshooting Errors	64
Assemble the Proportioner	25	Troubleshooting	65
Mount the System	25	Error Codes and Troubleshooting	65
Setup	26	USB Data	66
Grounding	26	Download Procedure	66
General Equipment Guidelines	26	USB Logs	66
Connect Power	27	Event Log	66
Supply Wet Cups With Throat Seal Liquid (TSL)	28	Job Log	67
Install Fluid Temperature Sensor	28	Daily Log	67
Connect Heated Hose to Proportioner	29	System Software Log	67
Advanced Display Module (ADM) Operation	30	Blackbox Log File	67
Setup Mode	31	Diagnostic Log File	67
Set Password	31	System Configuration Settings	67
Advanced Setup Screens	33	Custom Language File	68
System 1	34	Create Custom Language Strings	68
System 2	34	Upload Procedure	68
System 3	34	Performance Charts	69
Recipes	35	Proportioners For Foam	69
Cellular Screen	35	Proportioners For Coatings	70
Run Mode	36	Heater Performance Chart	72
System Events	42	Technical Specifications	73
		Graco Extended Warranty for Reactor® 2 Components	75

Warnings

The following warnings are for the setup, use, grounding, maintenance, and repair of this equipment. The exclamation point symbol alerts you to a general warning and the hazard symbols refer to procedure-specific risks. When these symbols appear in the body of this manual or on warning labels, refer back to these Warnings. Product-specific hazard symbols and warnings not covered in this section may appear throughout the body of this manual where applicable.

 DANGER	
 	<p>SEVERE ELECTRIC SHOCK HAZARD</p> <p>This equipment can be powered by more than 240 V. Contact with this voltage will cause death or serious injury.</p> <ul style="list-style-type: none"> Turn off and disconnect power at the main switch before disconnecting any cables and before servicing equipment. This equipment must be grounded. Connect only to grounded power source. All electrical wiring must be done by a qualified electrician and comply with all local codes and regulations.
 WARNING	
	<p>TOXIC FLUID OR FUMES</p> <p>Toxic fluids or fumes can cause serious injury or death if splashed in the eyes or on skin, inhaled or swallowed.</p> <ul style="list-style-type: none"> Read Safety Data Sheet (SDS) for handling instructions and to know the specific hazards of the fluids you are using, including the effects of long-term exposure. When spraying, servicing equipment, or when in the work area, always keep work area well-ventilated and always wear appropriate personal protective equipment. See Personal Protective Equipment warnings in this manual. Store hazardous fluid in approved containers, and dispose of it according to applicable guidelines.
	<p>PERSONAL PROTECTIVE EQUIPMENT</p> <p>Always wear appropriate personal protective equipment and cover all skin when spraying, servicing equipment, or when in the work area. Protective equipment helps prevent serious injury, including long-term exposure; inhalation of toxic fumes, mists or vapors; allergic reaction; burns; eye injury and hearing loss. This protective equipment includes but is not limited to:</p> <ul style="list-style-type: none"> A properly fitting respirator, which may include a supplied-air respirator, chemically impermeable gloves, protective clothing and foot coverings as recommended by the fluid manufacturer and local regulatory authority. Protective eyewear and hearing protection.

! WARNING



SKIN INJECTION HAZARD

High-pressure fluid from dispensing device, hose, leaks, or ruptured components will pierce skin. This may look like just a cut, but it is a serious injury that can result in amputation. **Get immediate surgical treatment.**



- Engage trigger lock when not spraying.
- Do not point dispensing device at anyone or at any part of the body.
- Do not put your hand over the fluid outlet.
- Do not stop or deflect leaks with your hand, body, glove, or rag.
- Follow the **Pressure Relief Procedure** when you stop dispensing and before cleaning, checking, or servicing equipment.
- Tighten all fluid connections before operating the equipment.
- Check hoses and couplings daily, Replace worn or damaged parts immediately.



FIRE AND EXPLOSION HAZARD

Flammable fumes, such as solvents and paint fumes, in **work area** can ignite or explode. Paint and solvent flowing through the equipment can cause static sparking. To help prevent fire and explosion:



- Use equipment only in well ventilated area.
- Eliminate all ignition sources; such as pilot lights, cigarettes, portable electric lamps, and plastic drop cloths (potential static sparking).
- Ground all equipment in the work area. See **Grounding** instructions in your operation manual.
- Keep work area free of debris, including solvent, rags and gasoline.
- Do not plug or unplug power cords, or turn power or light switches on or off when flammable fumes are present.
- Use only grounded hoses.
- Hold gun firmly to side of grounded pail when triggering into pail. Do not use pail liners unless they are anti-static or conductive.
- **Stop operation immediately** if static sparking occurs or you feel a shock. Do not use equipment until you identify and correct the problem.
- Keep a working fire extinguisher in the work area.











THERMAL EXPANSION HAZARD

Fluids subjected to heat in confined spaces, including hoses, can create a rapid rise in pressure due to the thermal expansion. Over-pressurization can result in equipment rupture and serious injury.



- Open a valve to relieve the fluid expansion during heating.
- Replace hoses proactively at regular intervals based on your operating conditions.

! WARNING

	<p>PRESSURIZED ALUMINUM PARTS HAZARD</p> <p>Use of fluids that are incompatible with aluminum in pressurized equipment can cause serious chemical reaction and equipment rupture. Failure to follow this warning can result in death, serious injury, or property damage.</p> <ul style="list-style-type: none"> Do not use 1, 1, 1-trichloroethane, methylene chloride, other halogenated hydrocarbon solvents or fluids containing such solvents. Do not use chlorine bleach. Many other fluids may contain chemicals that can react with aluminum. Contact your material supplier for compatibility.
 	<p>PLASTIC PARTS CLEANING SOLVENT HAZARD</p> <p>Many solvents can degrade plastic parts and cause them to fail, which could cause serious injury or property damage.</p> <ul style="list-style-type: none"> Use only compatible solvents to clean plastic structural or pressure-containing parts. See Technical Specifications in all equipment instruction manuals for materials of construction. Consult the solvent manufacturer for information and recommendations about compatibility.
 	<p>EQUIPMENT MISUSE HAZARD</p> <p>Misuse can cause death or serious injury.</p> <ul style="list-style-type: none"> Do not operate the unit when fatigued or under the influence of drugs or alcohol. Do not exceed the maximum working pressure or temperature rating of the lowest rated system component. See Technical Specifications in all equipment manuals. Use fluids and solvents that are compatible with equipment wetted parts. See Technical Specifications in all equipment manuals. Read fluid and solvent manufacturer's warnings. For complete information about your material, request Safety Data Sheets (SDSs) from distributor or retailer. Do not leave the work area while equipment is energized or under pressure. Turn off all equipment and follow the Pressure Relief Procedure when equipment is not in use. Check equipment daily. Repair or replace worn or damaged parts immediately with genuine manufacturer's replacement parts only. Do not alter or modify equipment. Alterations or modifications may void agency approvals and create safety hazards. Make sure all equipment is rated and approved for the environment in which you are using it. Use equipment only for its intended purpose. Call your distributor for information. Route hoses and cables away from traffic areas, sharp edges, moving parts, and hot surfaces. Do not kink or over bend hoses or use hoses to pull equipment. Keep children and animals away from work area. Comply with all applicable safety regulations.
 	<p>MOVING PARTS HAZARD</p> <p>Moving parts can pinch, cut or amputate fingers and other body parts.</p> <ul style="list-style-type: none"> Keep clear of moving parts. Do not operate equipment with protective guards or covers removed. Equipment can start without warning. Before checking, moving, or servicing equipment, follow the Pressure Relief Procedure and disconnect all power sources.
	<p>BURN HAZARD</p> <p>Equipment surfaces and fluid that is heated can become very hot during operation. To avoid severe burns:</p> <ul style="list-style-type: none"> Do not touch hot fluid or equipment.

Important Isocyanate Information

Isocyanates (ISO) are catalysts used in two component materials.

Isocyanate Conditions

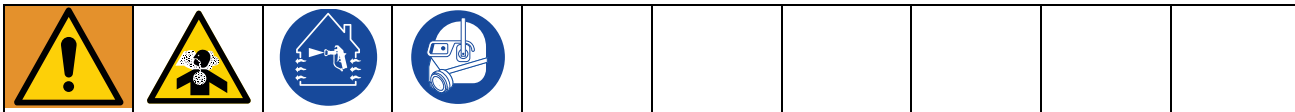



Spraying or dispensing fluids that contain isocyanates creates potentially harmful mists, vapors, and atomized particulates.



- Read and understand the fluid manufacturer’s warnings and Safety Data Sheet (SDS) to know specific hazards and precautions related to isocyanates.
- Use of isocyanates involves potentially hazardous procedures. Do not spray with this equipment unless you are trained, qualified, and have read and understood the information in this manual and in the fluid manufacturer’s application instructions and SDS.
- Use of incorrectly maintained or mis-adjusted equipment may result in improperly cured material, which could cause off gassing and offensive odors. Equipment must be carefully maintained and adjusted according to instructions in the manual.
- To prevent inhalation of isocyanate mists, vapors and atomized particulates, everyone in the work area must wear appropriate respiratory protection. Always wear a properly fitting respirator, which may include a supplied-air respirator. Ventilate the work area according to instructions in the fluid manufacturer’s SDS.
- Avoid all skin contact with isocyanates. Everyone in the work area must wear chemically impermeable gloves, protective clothing and foot coverings as recommended by the fluid manufacturer and local regulatory authority. Follow all fluid manufacturer recommendations, including those regarding handling of contaminated clothing. After spraying, wash hands and face before eating or drinking.
- Hazard from exposure to isocyanates continues after spraying. Anyone without appropriate personal protective equipment must stay out of the work area during application and after application for the time period specified by the fluid manufacturer. Generally this time period is at least 24 hours.
- Warn others who may enter work area of hazard from exposure to isocyanates. Follow the recommendations of the fluid manufacturer and local regulatory authority. Posting a placard such as the following outside the work area is recommended:



Material Self-Ignition

				
Some materials may become self-igniting if applied too thick. Read material manufacturer's warnings and SDS.				

Keep Components A and B Separate

				
Cross-contamination can result in cured material in fluid lines which could cause serious injury or damage to equipment. To prevent cross-contamination.				
<ul style="list-style-type: none"> • Never interchange component A and component B wetted parts. • Never use solvent on one side if it has been contaminated from the other side. 				

Change Material

NOTICE				
Changing the material types used in your equipment requires special attention to avoid equipment damage and downtime.				
<ul style="list-style-type: none"> • When changing materials, flush the equipment multiple times to ensure it is thoroughly clean. • Always clean the fluid inlet strainers after flushing. • Check with your material manufacturer for chemical compatibility. • When changing between epoxies and urethanes or polyureas, disassemble and clean all fluid components and change hoses. Epoxies often have amines on the B (hardener) side. Polyureas often have amines on the B (resin) side. 				

Moisture Sensitivity of Isocyanates

Exposure to moisture (such as humidity) will cause ISO to partially cure, forming small, hard, abrasive crystals that become suspended in the fluid. Eventually a film will form on the surface and the ISO will begin to gel, increasing in viscosity.

NOTICE				
Partially cured ISO will reduce performance and the life of all wetted parts.				
<ul style="list-style-type: none"> • Always use a sealed container with a desiccant dryer in the vent, or a nitrogen atmosphere. Never store ISO in an open container. • Keep the ISO pump wet cup or reservoir (if installed) filled with appropriate lubricant. The lubricant creates a barrier between the ISO and the atmosphere. • Use only moisture-proof hoses compatible with ISO. • Never use reclaimed solvents, which may contain moisture. Always keep solvent containers closed when not in use. • Always lubricate threaded parts with an appropriate lubricant when reassembling. 				

NOTE: The amount of film formation and rate of crystallization varies depending on the blend of ISO, the humidity, and the temperature.

Foam Resins with 245 fa Blowing Agents

Some foam blowing agents will froth at temperatures above 90°F (33°C) when not under pressure, especially if agitated. To reduce frothing, minimize preheating in a circulation system.

Models

Reactor 2 E-30 and E-30 Elite

All elite systems include fluid inlet sensors, ratio monitoring, and Xtreme-Wrap 50 ft (15 m) heated hose. For part numbers, see **Accessories**, page 10.

Model	E-30 Model						E-30 Elite Model					
	10 kW			15 kW			10 kW			15 kW		
Proportioner ★	272010			272011			272110			272111		
Maximum Fluid Working Pressure psi (MPa, bar)	2000 (14, 140)			2000 (14, 140)			2000 (14, 140)			2000 (14, 140)		
Approximate Output per Cycle (A+B) gal. (liter)	0.0272 (0.1034)			0.0272 (0.1034)			0.0272 (0.1034)			0.0272 (0.1034)		
Max Flow Rate lb/min (kg/min)	30 (13.5)			30 (13.5)			30 (13.5)			30 (13.5)		
Total System Load † ◇ (Watts)	17,900			23,000			17,900			23,000		
Configurable Voltage Phase ◇	200-240 VAC 1Ø	200-240 VAC 3ØΔ	350-415 VAC 3ØY	200-240 VAC 1Ø	200-240 VAC 3ØΔ	350-415 VAC 3ØY	200-240 VAC 1Ø	200-240 VAC 3ØΔ	350-415 VAC 3ØY	200-240 VAC 1Ø	200-240 VAC 3ØΔ	350-415 VAC 3ØY
Full Load Peak Current*	78	50	34	100	62	35	78	50	34	100	62	35

Fusion AP Package ‡ (Gun Part No.)	AP2010 (246102)	AH2010 (246102)	AP2011 (246102)	AP2011 (246102)	AP2110 (246102)	AH2110 (246102)	AP2111 (246102)	AH2111 (246102)
Fusion CS Package ‡ (Gun Part No.)	CS2010 (CS02RD)	CH2010 (CS02RD)	CS2011 (CS02RD)	CH2011 (CS02RD)	CS2110 (CS02RD)	CH2110 (CS02RD)	CS2111 (CS02RD)	CH2111 (CS02RD)
Probler P2 Package ‡ (Gun Part No.)	P22010 (GCP2R2)	PH2010 (GCP2R2)	P22011 (GCP2R2)	PH2011 (GCP2R2)	P22110 (GCP2R2)	PH2110 (GCP2R2)	P22111 (GCP2R2)	PH2111 (GCP2R2)
Heated Hose 50 ft (15 m)	24K240	24K240	24K240	24K240	24Y240	24Y240	24Y240	24Y240
24K240 (scuff guard) 24Y240 (Xtreme-Wrap)	Qty. 1	Qty. 5	Qty. 1	Qty. 5	Qty. 1	Qty. 5	Qty. 1	Qty. 5
Heated Whip Hose 10 ft (3 m)	246050		246050		246050		246050	
Ratio Monitoring					✓		✓	
Fluid Inlet Sensors (2)					✓		✓	

* Full load amps with all devices operating at maximum capabilities. Fuse requirements at various flow rates and mix chamber sizes may be less.

† Total system watts used by system, based on maximum heated hose length for each unit.

- E-30 and E-XP2 series: 310 ft (94.5 m) maximum heated hose length, including whip hose.

★ See **Approvals**, page 10.

‡ Packages include gun, heated hose, and whip hose. Elite packages also include ratio monitoring and fluid inlet sensors.

◇ Low line input voltage will reduce power available and heaters will not perform at full capacity.

Voltage Configurations Key	
Ø	Phase
Δ	DELTA
Y	WYE

Reactor 2 E-XP2 and E-XP2 Elite

All elite systems include fluid inlet sensors and Xtreme-Wrap 50 ft (15 m) heated hose. For part numbers, see **Accessories**, page 10.

Model	E-XP2 Model			E-XP2 Elite Model		
	15 kW			15 kW		
Proportioner ★	272012			272112		
Maximum Fluid Working Pressure psi (MPa, bar)	3500 (24.1, 241)			3500 (24.1, 241)		
Approximate Output per Cycle (A+B) gal. (liter)	0.0203 (0.0771)			0.0203 (0.0771)		
Max Flow Rate lb/min (kg/min)	2 (7.6)			2 (7.6)		
Total System Load † ◇ (Watts)	23,000			23,000		
Configurable Voltage Phase ◇	200-240 VAC 1Ø	200-240 VAC 3Ø Δ	350-415 VAC 3ØY	200-240 VAC 1Ø	200-240 VAC 3Ø Δ	350-415 VAC 3ØY
Full Load Peak Current*	100	62	35	100	62	35

Fusion AP Package ‡ (Gun Part No.)	AP2012 (246100)	AP2112 (246100)
Fusion P2 Package ‡ (Gun Part No.)	P22012 (GCP2R1)	P22112 (GCP2R1)
Heated Hose 50 ft (15 m)	24K241 (scuff guard)	24Y241 (Xtreme-Wrap)
Heated Whip Hose 10 ft (3 m)	246055	246055
Fluid Inlet Sensors (2)		✓
Ratio Monitoring		✓

* Full load amps with all devices operating at maximum capabilities. Fuse requirements at various flow rates and mix chamber sizes may be less.

† Total system watts used by system, based on maximum heated hose length for each unit.

- E-30 and E-XP2 series: 310 ft (94.5 m) maximum heated hose length, including whip hose.

★ See **Approvals**, page 10.

‡ Packages include gun, heated hose, and whip hose. Elite packages also include ratio monitoring and fluid inlet sensors.

◇ Low line input voltage will reduce power available and heaters will not perform at full capacity.

Voltage Configurations Key	
Ø	Phase
Δ	DELTA
Y	WYE

Approvals

Intertek approvals apply to proportioners without hoses.

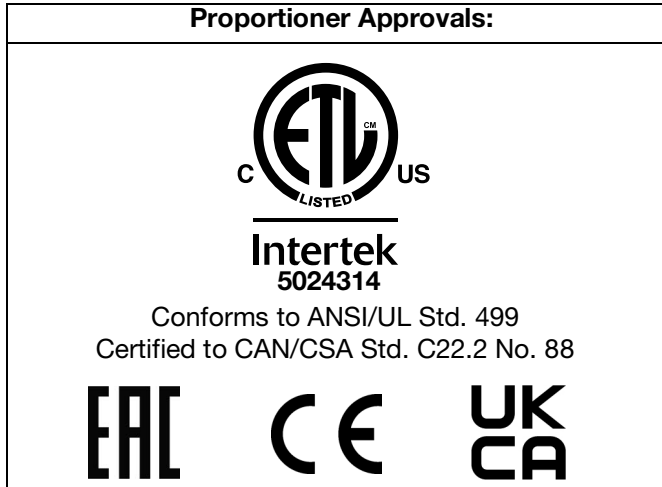

Accessories

Kit Number	Description
24U315	Air Manifold Kit (4 outlets)
24U314	Wheel and Handle Kit
16X521	Graco InSite Extension cable, 24.6 ft (7.5 m)
24N449	50 ft (15 m) CAN cable (for remote display module)
24K207	Fluid Temperature Sensor (FTS) with RTD
24U174	Remote Display Module Kit
24K337	Light Tower Kit
15V551	ADM Protective Covers (10 pack)
15M483	Remote Display Module Protective Covers (10 pack)
24M174	Drum Level Sticks
121006	150 ft (45 m) CAN cable (for remote display module)
24N365	RTD Test Cables (to aid resistance measurements)
24N748	Ratio Monitoring Kit
979200	Integrates PowerStation, Tier 4 Final, no air
979201	Integrated PowerStation, Tier 4 Final, 20 cfm
979202	Integrated PowerStation, Tier 4 Final, 35 cfm

Supplied Manuals

The following manuals are shipped with the Reactor 2. Refer to these manuals for detailed equipment information.

Manuals are also available at www.graco.com.

Manual	Description
333023	Reactor 2 E-30 and E-XP2 Operation
333091	Reactor 2 E-30 and E-XP2 Startup Quick Guide
333092	Reactor 2 E-30 and E-XP2 Shutdown Quick Guide

Related Manuals

The following manuals are for accessories used with the Reactor.

Manuals are available at www.graco.com.

Manual in English	Description
System Manuals	
333024	Reactor 2 E-30 and E-XP2, Repair-Parts
Displacement Pump Manual	
309577	Electric Reactor Displacement Pump, Repair-Parts
Feed System Manuals	
309572	Heated Hose, Instructions-Parts
309852	Circulation and Return Tube Kit, Instructions-Parts
309815	Feed Pump Kits, Instructions-Parts
309827	Feed Pump Air Supply Kit, Instructions-Parts
Spray Gun Manuals	
309550	Fusion® AP Gun
3A7314	Fusion® PC Gun
312666	Fusion® CS Gun
313213	Probler® P2 Gun
Accessory Manuals	
3A1906	Light Tower Kit, Instructions-Parts
3A1907	Remote Display Module Kit, Instructions-Parts
332735	Air Manifold Kit, Instructions-Parts
332736	Handle and Wheel Kit, Instructions-Parts
3A6738	Ratio Monitor Kit, Instructions
3A6335	Integrated PowerStation, Instructions

Typical Installation, without circulation

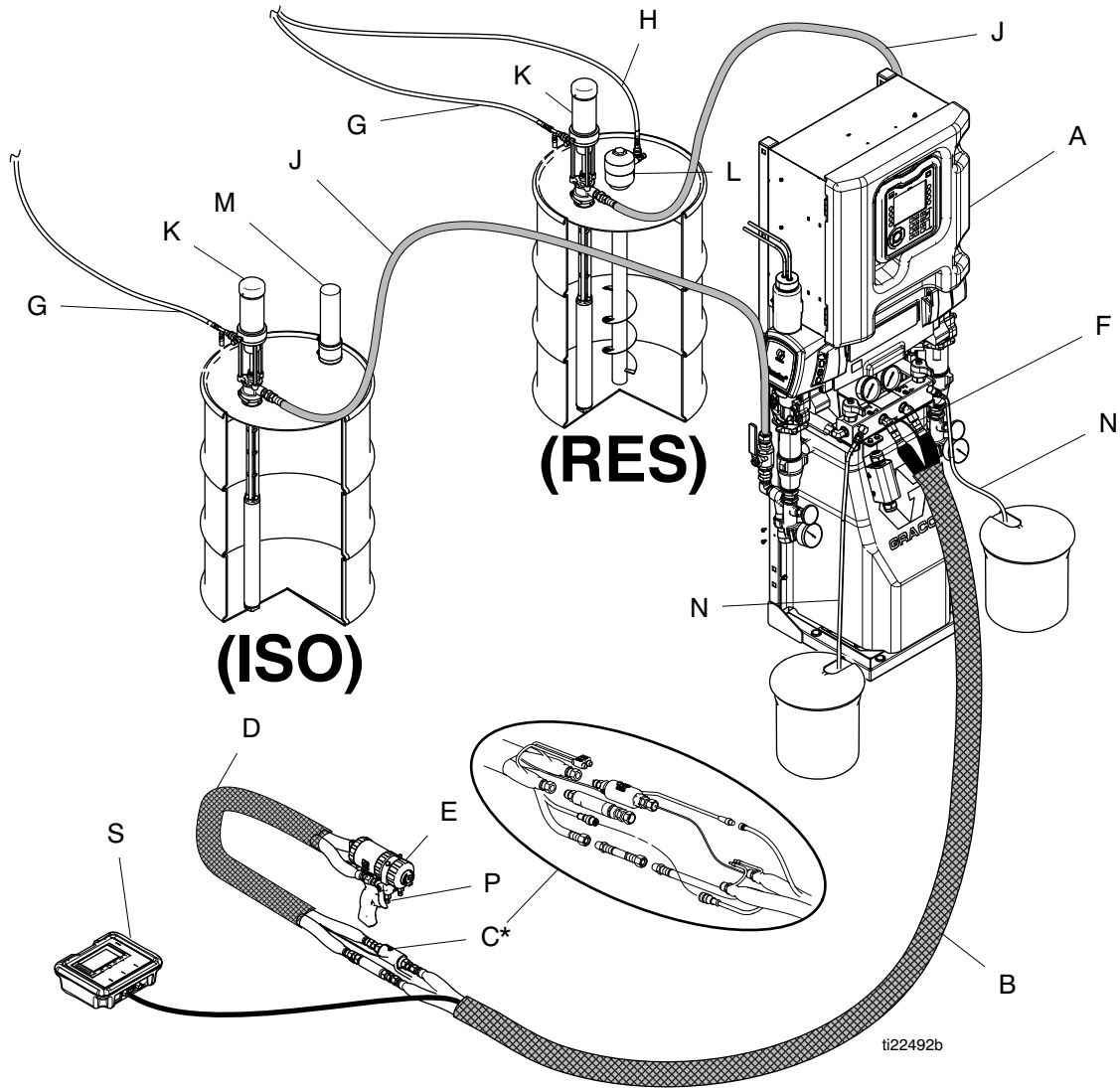

FIG. 1

* Shown exposed for clarity. Wrap with tape during operation.

Key:

- | | | | |
|---|--------------------------------|---|--------------------------------------|
| A | Reactor 2 Proportioner | J | Fluid Supply Lines |
| B | Heated Hose | K | Feed Pumps |
| C | Fluid Temperature Sensor (FTS) | L | Agitator |
| D | Heated Whip Hose | M | Desiccant Dryer |
| E | Fusion Spray Gun | N | Bleed Lines |
| F | Gun Air Supply Hose | P | Gun Fluid Manifold (part of gun) |
| G | Feed Pump Air Supply Lines | S | Remote Display Module Kit (optional) |
| H | Agitator Air Supply Line | | |

Typical Installation, with system fluid manifold to drum circulation

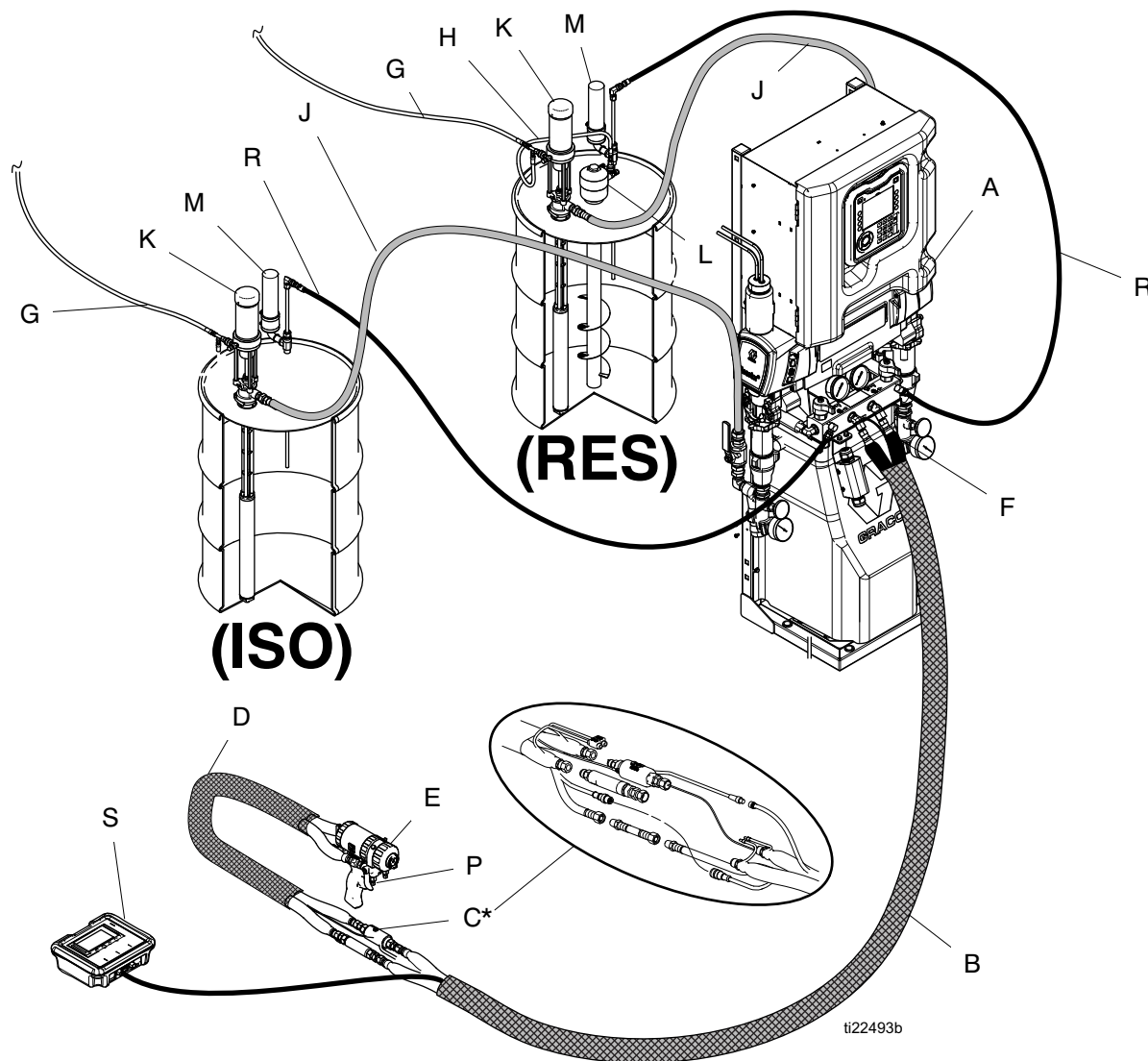

FIG. 2

* Shown exposed for clarity. Wrap with tape during operation.

Key:

- | | | | |
|---|--------------------------------|---|--------------------------------------|
| A | Reactor 2 Proportioner | J | Fluid Supply Lines |
| B | Heated Hose | K | Feed Pumps |
| C | Fluid Temperature Sensor (FTS) | L | Agitator |
| D | Heated Whip Hose | M | Desiccant Dryer |
| E | Fusion Spray Gun | P | Gun Fluid Manifold (part of gun) |
| F | Gun Air Supply Hose | R | Recirculation Lines |
| G | Feed Pump Air Supply Lines | S | Remote Display Module Kit (optional) |
| H | Agitator Air Supply Line | | |

Typical Installation, with gun fluid manifold to drum circulation

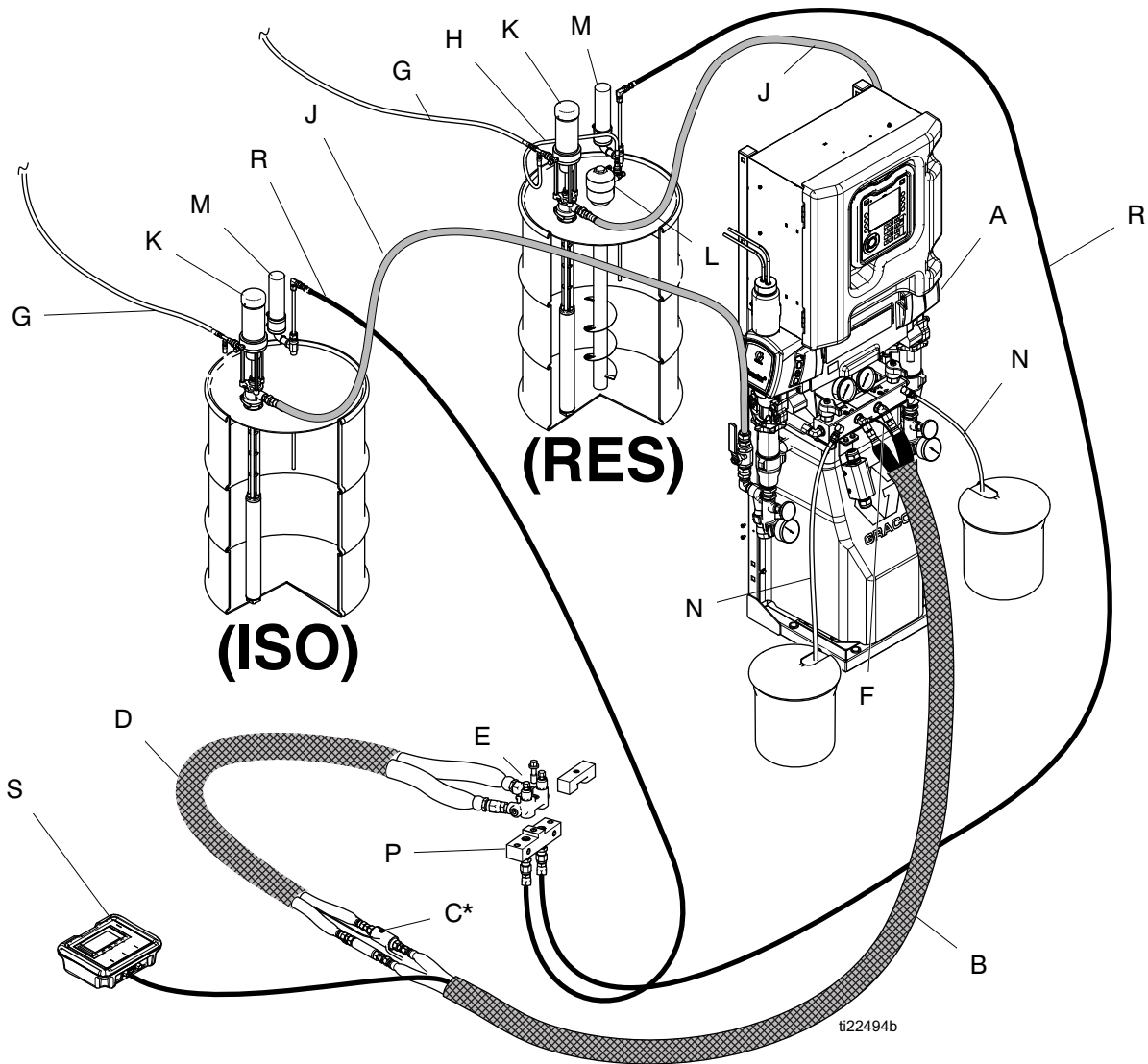

FIG. 3

* Shown exposed for clarity. Wrap with tape during operation.

Key:

- | | | | |
|----|--------------------------------|---|--------------------------------------|
| A | Reactor 2 Proportioner | J | Fluid Supply Lines |
| B | Heated Hose | K | Feed Pumps |
| C | Fluid Temperature Sensor (FTS) | L | Agitator |
| CK | Circulation Block (accessory) | M | Desiccant Dryer |
| D | Heated Whip Hose | P | Gun Fluid Manifold (part of gun) |
| F | Gun Air Supply Hose | R | Recirculation Lines |
| G | Feed Pump Air Supply Lines | S | Remote Display Module Kit (optional) |
| H | Agitator Air Supply Line | | |

Component Identification

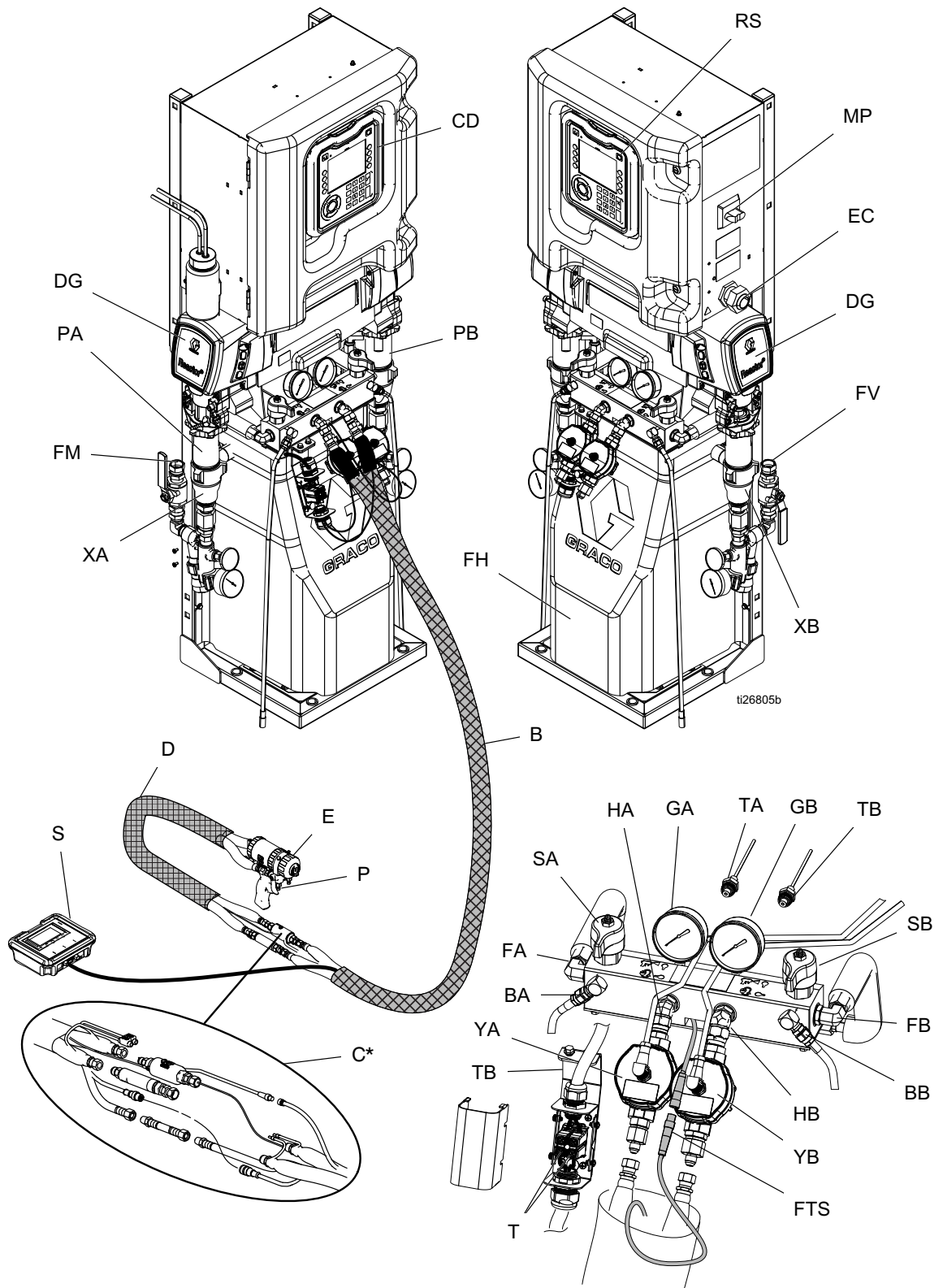

FIG. 4

Component Identification

Key:

BA	ISO Side Pressure Relief Outlet	MP	Main Power Switch
BB	RES Side Pressure Relief Outlet	PA	ISO Side Pump
CD	Advanced Display Module (ADM)	PB	RES Side Pump
DG	Drive Gear Housing	RS	Red Stop Button
EC	Electrical Cord Strain Relief	SA	ISO Side PRESSURE RELIEF/SPRAY Valve
EM	Electric Motor	SB	RES Side PRESSURE RELIEF/SPRAY Valve
FA	ISO Side Fluid Manifold Inlet	S	Remote Display Module (optional)
FB	RES Side Fluid Manifold Inlet	T	Heated Hose Power Termination Box
FH	Fluid Heaters (behind shroud)	TA	ISO Side Pressure Transducer (behind gauge GA)
FM	Reactor Fluid Manifold	TB	RES Side Pressure Transducer (behind gauge GB)
FV	Fluid Inlet Valve (RES side shown)	XA	Fluid Inlet Sensor (ISO side, Elite models only)
GA	ISO Side Pressure Gauge	XB	Fluid Inlet Sensor (RES side, Elite models only)
GB	RES Side Pressure Gauge	YA	Flow Meter (ISO side, Elite models only)
HA	ISO Side Hose Connection	YB	Flow Meter (RES side, Elite models only)
HB	RES Side Hose Connection		

Advanced Display Module (ADM)

The ADM display shows graphical and text information related to setup and spray operations.









t22631a

FIG. 5: ADM Front View

NOTICE

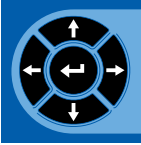
To prevent damage to the soft key buttons, do not press buttons with sharp objects such as pens, plastic cards, or fingernails.

Table 1: ADM Keys and Indicators

Key	Function
 Startup/ Shutdown Key and Indicator	Press to startup or shutdown the system.
 Stop	Press to stop all proportioner processes. This is not a safety or emergency stop.
 Soft Keys	Press to select the specific screen or operation shown on the display directly next to each key.
 Navigation Keys	<ul style="list-style-type: none"> <i>Left/Right Arrows:</i> Use to move from screen to screen. <i>Up/Down Arrows:</i> Use to move among fields on a screen, items on a dropdown menu, or multiple screens within a function.
Numeric Keypad	Use to input values.
 Cancel	Use to cancel a data entry field.
 Setup	Press to enter or exit Setup mode.
 Enter	Press to choose a field to update, to make a selection, to save a selection or value, to enter a screen, or to acknowledge an event.

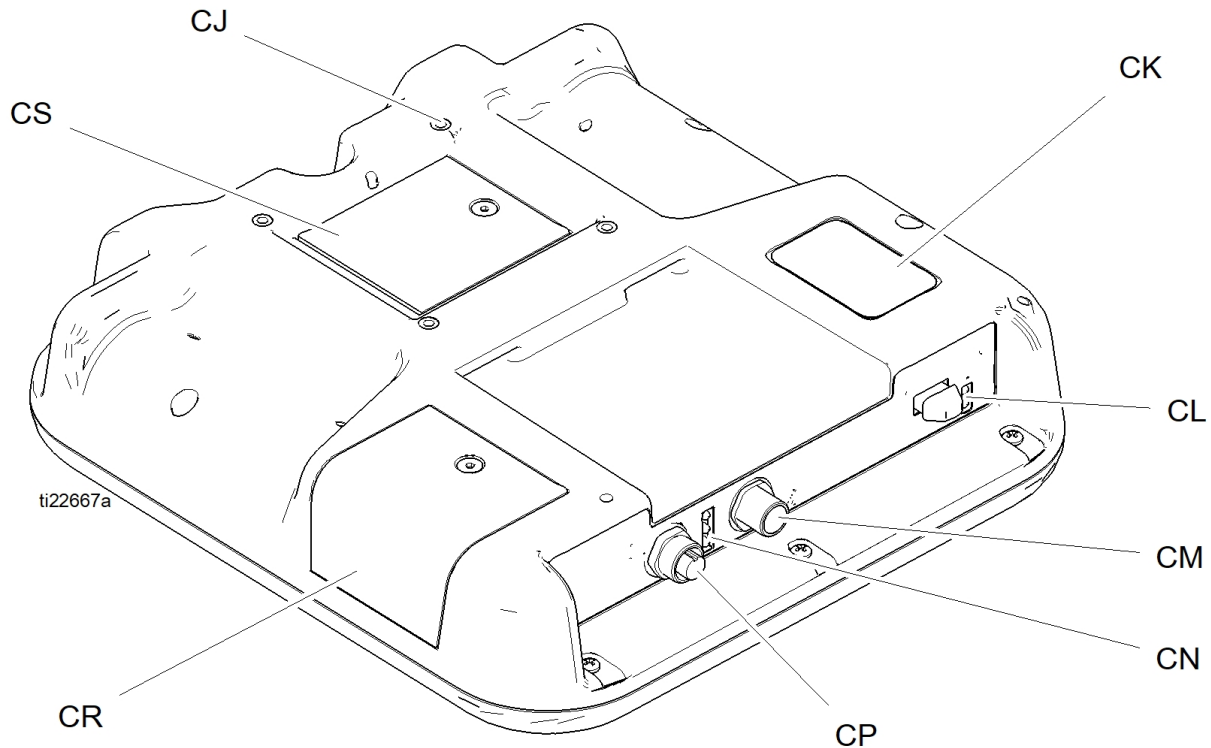



FIG. 6: Back View

Key:

- CJ Flat Panel Mount (VESA 100)
- CK Model and Serial Number
- CL USB Port and Status LEDs
- CM CAN Cable Connection

- CN Module Status LEDs
- CP Accessory Cable Connection
- CR Token Access Cover
- CS Battery Access Cover

Table 2: ADM LED Status Descriptions

LED	Conditions	Description
System Status 	Green Solid	Run Mode, System On
	Green Flashing	Setup Mode, System On
	Yellow Solid	Run Mode, System Off
	Yellow Flashing	Setup Mode, System Off
USB Status (CL)	Green Flashing	Data recording in progress
	Yellow Solid	Downloading information to USB
	Green and Yellow Flashing	ADM is busy, USB cannot transfer information when in this mode
ADM Status (CN)	Green Solid	Power applied to module
	Yellow Solid	Active Communication
	Red Steady Flashing	Software upload from token in progress
	Red Random Flashing or Solid	Module error exists

ADM Display Details

Power Up Screen

The following screen appears when the ADM is powered up. It remains on while the ADM runs through initialization and establishes communication with other modules in the system.



Menu Bar

The menu bar appears at the top of each screen (the following image is only an example).



Date and Time

The date and time are always displayed in one of the following formats. The time is always displayed as a 24-hour clock.

- DD / MM / YY HH:MM
- YY / MM / DD HH:MM
- MM / DD / YY HH:MM

Arrows

The left and right arrows indicate screen navigation.

Screen Menu

The screen menu indicates the currently active screen, which is highlighted. It also indicates the associated screens that are available by scrolling left and right.

System Mode

The current system mode is displayed at the lower left of the menu bar.

System Errors

The current system error is displayed in the middle of the menu bar. There are four possibilities:

Icon	Function
No Icon	No information or no error has occurred
	Advisory
	Deviation
	Alarm

Refer to **Troubleshooting Errors**, page 64, for more information.

Status

The current system status is displayed at the lower right of the menu bar.

Navigate the Screen

There are two sets of screens:

- **Run screens** - control spraying operations and display system status and data.
- **Setup screens** - control system parameters and advances features.











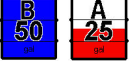

Press on any Run screen to enter the Setup screens. If the system has a password lock, the Password screen displays. If the system is not locked (password is set to 0000), System Screen 1 displays.

Press on any Setup screen to return to the Home screen.

Press the Enter soft key to activate the editing function on any screen.

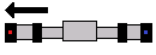
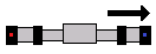
Press the Exit soft key to exit any screen. Use the other soft keys to select the function adjacent to them.

Icons









Icon	Function
	Component A
	Component B
	Estimated Supply Material
J20	Jog Mode Speed
	Pressure
	Cycle Counter (press and hold)
	Advisory. See Errors Screens , page 39, for more information.
	Deviation. See Errors Screens , page 39, for more information.
	Alarm. See Errors Screens , page 39, for more information.
	Pump Moving Left
	Pump Moving Right
120 °F 	Hose Temperature in Hose FTS Mode
120 °F 	Hose Temperature in Hose Resistance Mode
20 ^A 	Hose Amps in Manual Mode















Soft Keys

Icons next to the soft keys indicate which mode or action is associated with each soft key. Soft keys that do not have an icon next to them are not active on the current screen.

NOTICE

To prevent damage to the soft key buttons, do not press buttons with sharp objects such as pens, plastic cards, or fingernails.

Icon	Function
	Start Proportioner
	Start and Stop Proportioner in Jog Mode
	Stop Proportioner
	Turn on or off the specified heat zone
	Park pump
	Enter Jog Mode. See Jog Mode , page 47.
	Reset Cycle Counter (press and hold)
	Select Recipe
	Search

Icon	Function
	Move Cursor Left One Character
	Move Cursor Right One Character
	Toggle between upper-case, lower-case, and numbers and special characters
	Backspace
	Cancel
	Clear
	Troubleshoot Selected Error
	Increase value
	Decrease value
	Next screen
	Previous screen
	Return to first screen
	Calibrate
	Continue

Electrical Enclosure

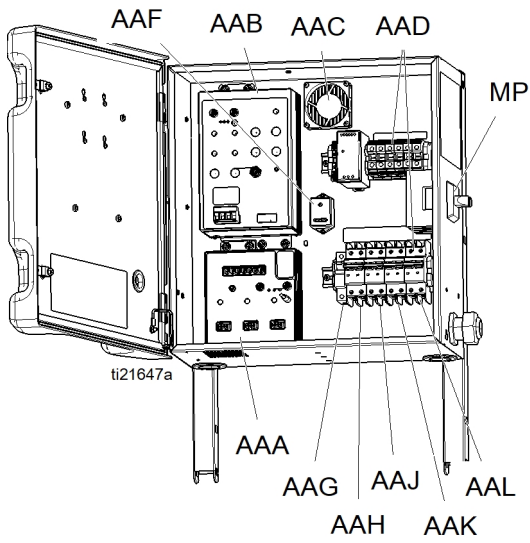

Key:

- AAA Temperature Control Module (TCM)
- AAB Motor Control Module (MCM)
- AAC Enclosure Fan
- AAD Wiring Terminal Blocks
- AAE Power Supply
- AAF Surge Protector
- AAG Hose Breaker
- AAH Motor Breaker
- AAJ A Side Heat Breaker
- AAK B Side Heat Breaker
- AAL Transformer Breaker
- AAM Terminal Ground
- MP Main Power Switch

Motor Control Module (MCM)

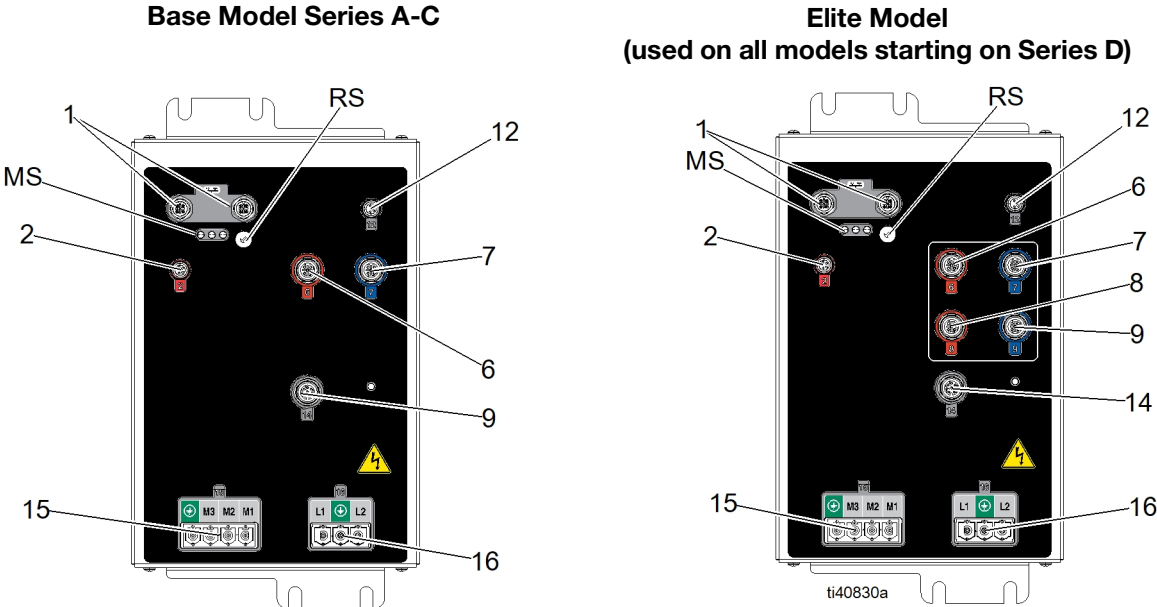

FIG. 7

Ref.	Description
MS	Module Statue LEDs see LED Status Table
1	CAN Communication Connections
2	Motor Temperature
3	Not used
4	Not used
5	Not used
6	A Pump Output Pressure
7	B Pump Output Pressure
8	A Fluid Inlet Sensor (Elite only)
9	B Fluid Inlet Sensor (Elite only)

Ref.	Description
10	Accessory output
11	Not used
12	Pump Cycle Counter
14	Graco Insite™
15	Motor Power Output
16	Main Power Input
RS*	Rotary Switch

*** MCM Rotary Switch Positions**

- 2 = E-30
- 3 = E-XP2

Table 3: MCM Module LED (MS) Status Descriptions

LED	Conditions	Description
MCM Status	Green Solid	Power applied to module
	Yellow Flashing	Active Communication
	Red steady Flashing	Software upload from token in progress
	Red Random Flashing or Solid	Module error exists

Temperature Control Module (TCM) Cable Connections

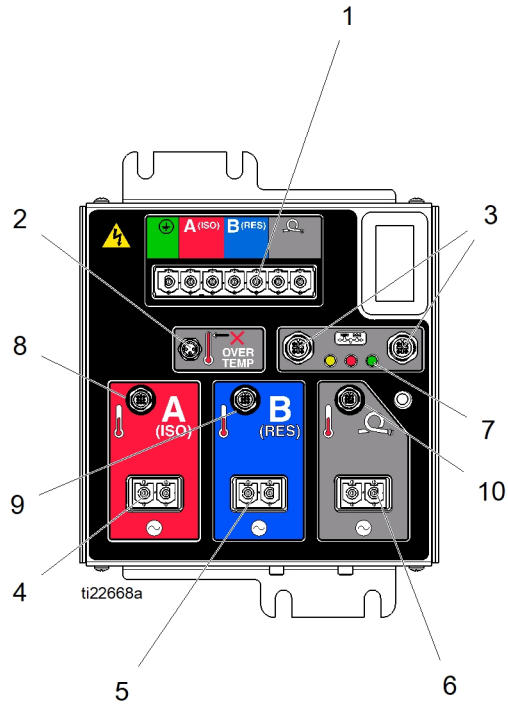

FIG. 8

Ref.	Description
1	Power Input
2	Heater Overtemperature
3	CAN Communications Connections
4	Power Out (ISO)
5	Power Out (RES)
6	Power Out (Hose)
7	Module Status LEDs
8	Heater A Temperature (ISO)
9	Heater B Temperature (RES)
10	Hose Temperature

Table 4: TCM Module LED (7) Status Description

LED	Conditions	Description
TCM Status	Green Solid	Power applied to module
	Yellow Flashing	Active Communication
	Red steady Flashing	Software upload from token in progress
	Red Random Flashing or Solid	Module error exists

Installation

Assemble the Proportioner

Reactor 2 proportioners arrive in a shipping configuration. Before mounting the system, assemble the proportioner in the upright position.

1. Remove bolts (A) and nuts.
2. Swing the electrical enclosure upright.
3. Reinstall bolts (A) with nuts. Tighten bolt (B) and nut.
4. Position the cable bundles against the frame. Attach the bundles to the frame with a loose wire tie (C) on each side.

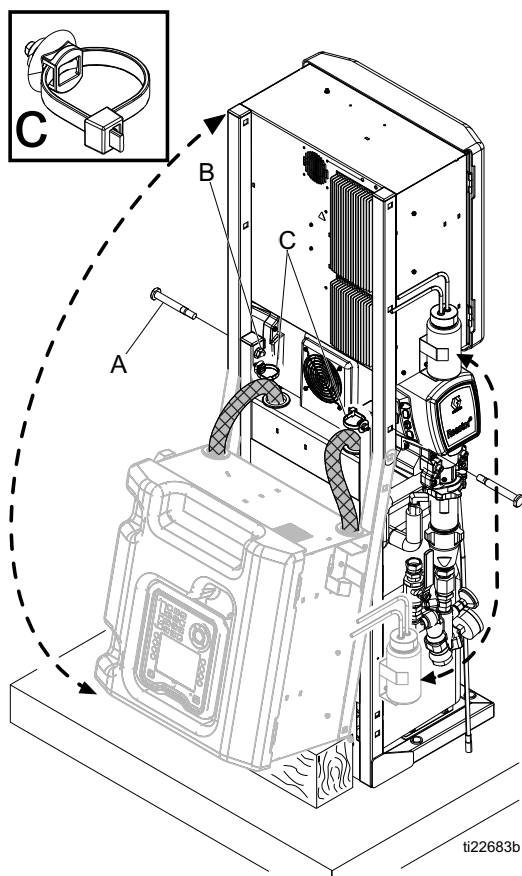

ti22683b

Mount the System



To prevent serious injury due to system tipping over, ensure Reactor is properly secured to wall.

NOTE: Mounting brackets and bolts are included in the box of loose parts, shipped with your system.

1. Use the supplied bolts to install the supplied L-brackets onto the system frame in the top-most square holes. Install brackets on both the left and right side of system frame.
2. Secure the L-brackets to the wall. If L-brackets do not line up with the wall stud spacing, bolt a piece of wood to the studs then secure L-brackets to wood.
3. Use the four holes in the base of the system frame to secure base to the flow. Bolts not supplied.

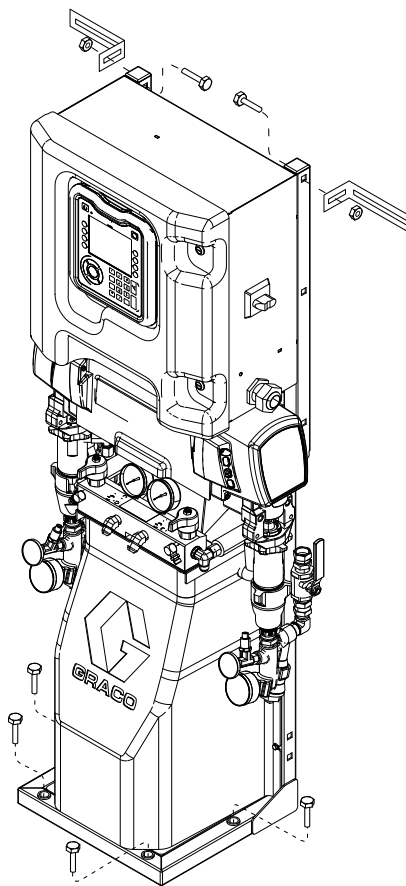

Setup

Grounding



The equipment must be grounded to reduce the risk of static sparking. Static sparking can cause fumes to ignite or explode. Grounding provides an escape wire for the electric current.

- *Reactor*: system is grounded through the power cord.
- *Spray gun*: connect whip hose ground wire to FTS. See **Install Fluid Temperature Sensor**, page 28. Do not disconnect ground wire or spray without whip hose.
- *Fluid supply containers*: follow your local code.
- *Object being sprayed*: follow your local code.
- *Solvent pails used when flushing*: follow your local code. Use only metal pails, which are conductive, placed on a grounded surface. Do not place pail on a non-conductive surface, such as paper or cardboard, which interrupts grounding continuity.
- *To maintain grounding continuity when flushing or relieving pressure*: hold a metal part of spray gun firmly to the side of a grounded *metal* pail, then trigger gun.

General Equipment Guidelines

NOTICE

Failure to properly size the equipment may result in damage. To avoid damage to the equipment, follow the guidelines listed below.

- Determine the correct size generator. Using the correct size generator and proper air compressor will enable the proportioner to run at a nearly constant RPM. Failure to do so will cause voltage fluctuations that can damage electrical equipment. Ensure that the generator matches the voltage and phase of the proportioner.

Use the following procedure to determine the correct size generator.



1. List peak wattage requirements of all system components.
2. Add the wattage required by the system components.
3. Perform the following equation: Total watts x 1.25 = kVA (kilovolt-amperes).
4. Select the electrical ratings in **Models**, to determine the correct size power cord.

NOTICE

Undersized power cords can cause voltage fluctuations that can damage electrical equipment and may cause the power cable to overheat.

- Use an air compressor with continuous run head unloading devices. Direct online air compressors that start and stop during a job will cause voltage fluctuations that can damage electrical equipment.
- Maintain and inspect the generator, air compressor, and other equipment per the manufacturer recommendations to avoid an unexpected shutdown. Unexpected equipment shutdown will cause voltage fluctuations that can damage electrical equipment.
- Use a wall power supply with enough current to meet system requirements. Failure to do so will cause voltage fluctuations that can damage electrical equipment.

Connect Power

				
All electrical wiring must be done by a qualified electrician and comply with all local codes and regulations.				

1. Turn main power switch (MP) OFF.
2. Open electrical enclosure door.

NOTE: Terminal jumpers are located inside the electrical enclosure door.

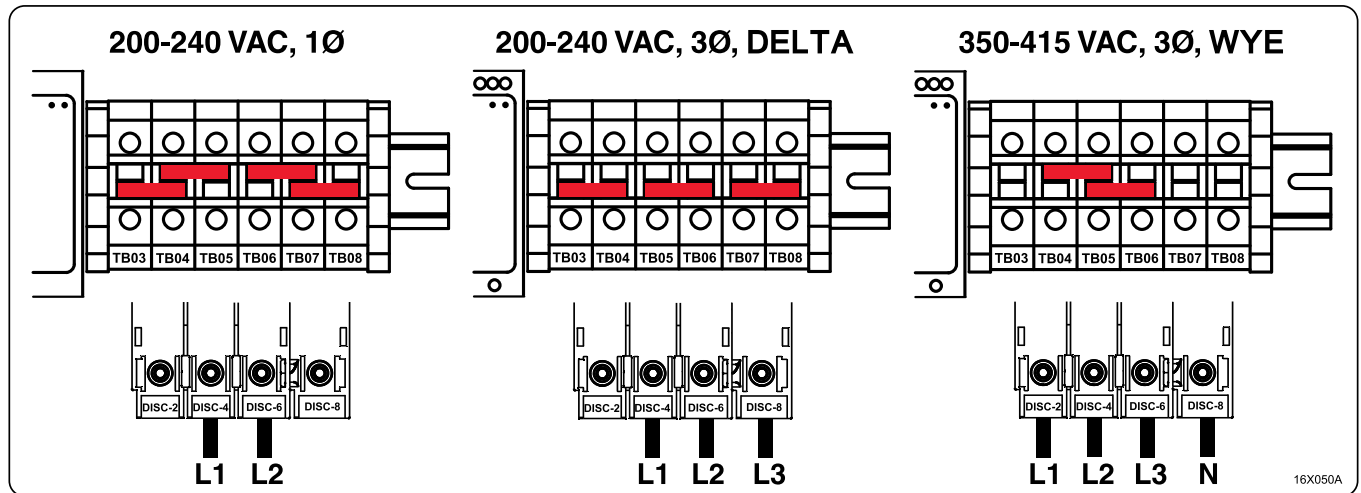

3. Install supplied terminal jumpers in the positions shown in image for the power source used.
4. Route power cable through strain relief (EC) in electrical enclosure.
5. Connect incoming power wires as shown in image. Gently pull on all connections to verify they are properly secured.
6. Verify all items are connected properly as shown in image then close electrical enclosure door.



NOTE: 350-415 VAC systems are not designed to operate from 480 VAC power source.

See **Models** for Reactor power requirements.

Supply Wet Cups With Throat Seal Liquid (TSL)

				
<p>Pump rod and connecting rod move during operation. Moving parts can cause serious injury such as pinching or amputations. Keep hands and fingers away from wet-cup during operation.</p>				

To prevent the pump from moving, turn the main power switch OFF.



- Component A (ISO) Pump:** Keep reservoir (R) filled with Graco Throat Seal Liquid (TSL), Part 206995. Wet-cup piston circulates TSL through wet-cup, to carry away isocyanate film on displacement rod.

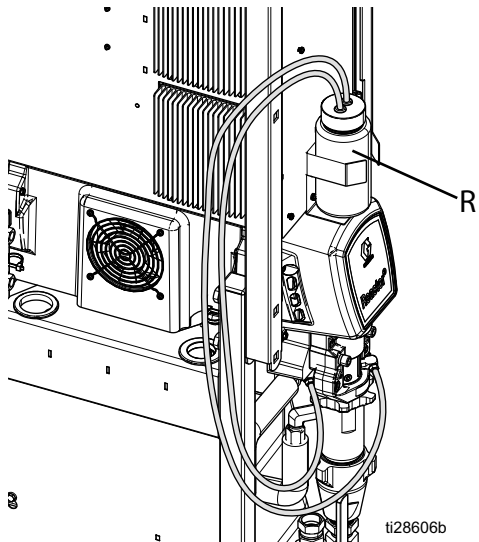

FIG. 9: Component A Pump

- Component B (Resin) Pump:** Check felt washers in packing nut/wet-cup (S) daily. Keep saturated with Graco Throat Seal Liquid (TSL), Part No. 206995, to prevent material from hardening on displacement rod. Replace felt washers when worn or contaminated with hardened material.

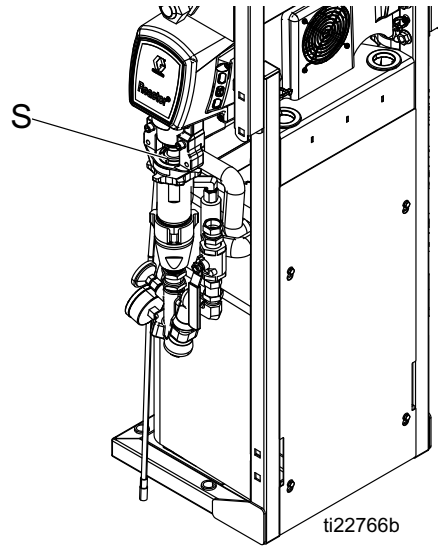

FIG. 10: Component B Pump

Install Fluid Temperature Sensor

The Fluid Temperature Sensor (FTS) is supplied. Install FTS between main hose and whip hose. See Heated Hose manual for instructions.

Connect Heated Hose to Proportioner

NOTICE

To avoid damage to the hose, only connect Reactor 2 proportioners to genuine Graco heated hoses.

Refer to Heated Hose manual for detailed connection instructions.

1. Turn off main power switch (MP).
2. For proportioners with termination box (TB):
 - a. Connect hose power wires to terminal block (T) on termination box (TB). Remove box cover and loosen lower strain relief (E). Route hose wires (V) through the box strain relief and fully insert into terminal block (T). A and B hose wire positions are not important. Torque to 35-50 in-lbs (4.0-5.6 N·m).
 - b. Fully tighten strain relief screws and replace cover.

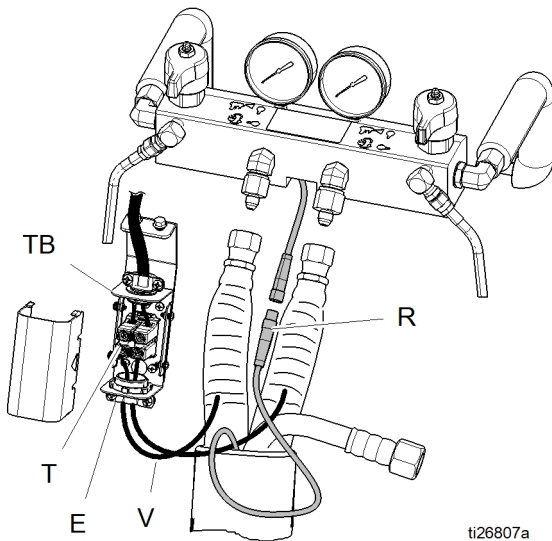

FIG. 11: Termination Box

3. For proportioners with electrical splice connectors (S):
 - a. Connect hose power wires to electrical splice connectors (S) from proportioner. Wrap connectors with electrical tape.

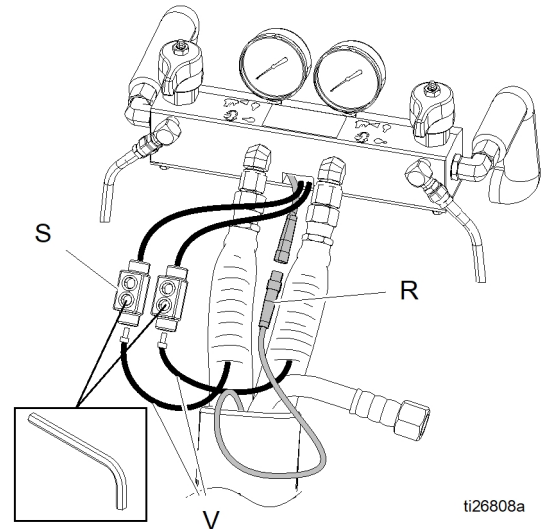

FIG. 12: Electrical Splice Connectors

4. Connect FTS cable connectors (R). Fully tighten RTD connectors, if provided.

Advanced Display Module (ADM) Operation

When main power is turned on by turning the main power switch (MP) to the ON position, the power up screen will be displayed until communication and initialization is complete.



Then the power key icon screen will display until the

ADM power on/off button (A)  is pressed for the first time after system power-up.

To begin using the ADM, the machine must be active. To verify that the System Status Indicator Light (B) is illuminated green, see **Advanced Display Module (ADM)**, page 17. If the System Status Indicator Light is not green, press the ADM Power on/off (A) button

. The System Status Indicator Light will illuminate yellow if the machine is disabled.

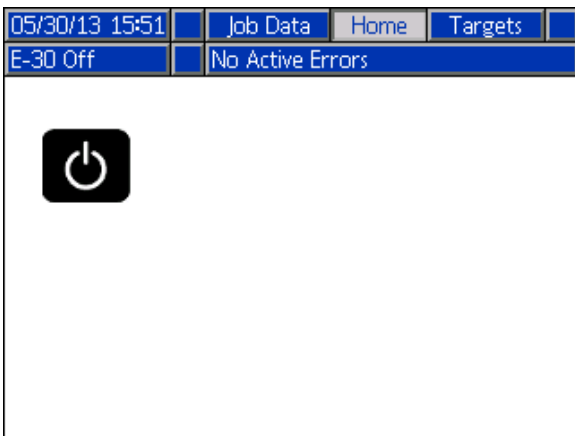

If Hose Resistance Mode is enabled, a reminder prompt will appear when the ADM becomes active.

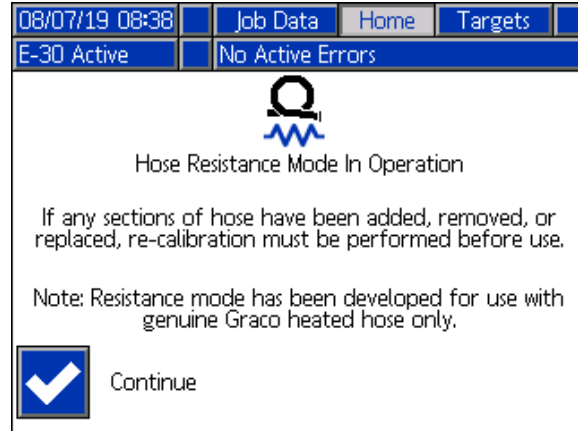



Press the Continue soft key  to clear the screen.

Perform the following tasks to fully setup your system.

1. Set pressure value for the Pressure Imbalance Alarm to activate. See **System 1**, page 34.
2. Enter, enable, or disable recipes. See **Recipes**, page 35.
3. Set general system settings. See **Advanced Screen 1 - General**, page 33.
4. Set units of measure. See **Advanced Screen 2 - Units**, page 33.
5. Set USB settings. See **Advanced Screen 3 - USB**, page 33.
6. Set target temperatures and pressure. See **Targets Screen**, page 38.
7. Set component A and component B supply levels. See **Maintenance Screen**, page 38.

Setup Mode

The ADM will start in the Run screens at the Home screen. From the Run screens, press  to access the Setup screens. The system defaults with no password, entered as 0000. Enter the current password then press .

Press     to navigate through the Setup Mode screens. See **FIG. 13: Setup Screens Navigation Diagram**, page 32.

Set Password

Set a password to allow Setup screen access, see **Advanced Screen 1 - General**, page 33. Enter any number from 0001 to 9999. To remove the password, enter the current password in the Advanced Screen - General screen and change the password to 0000.

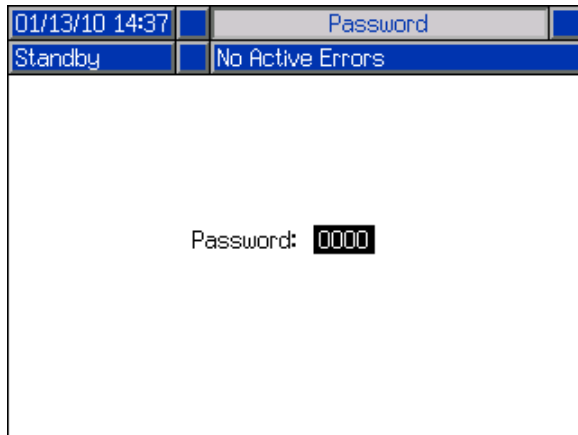

From the Setup screens, press  to return to the Run screens.

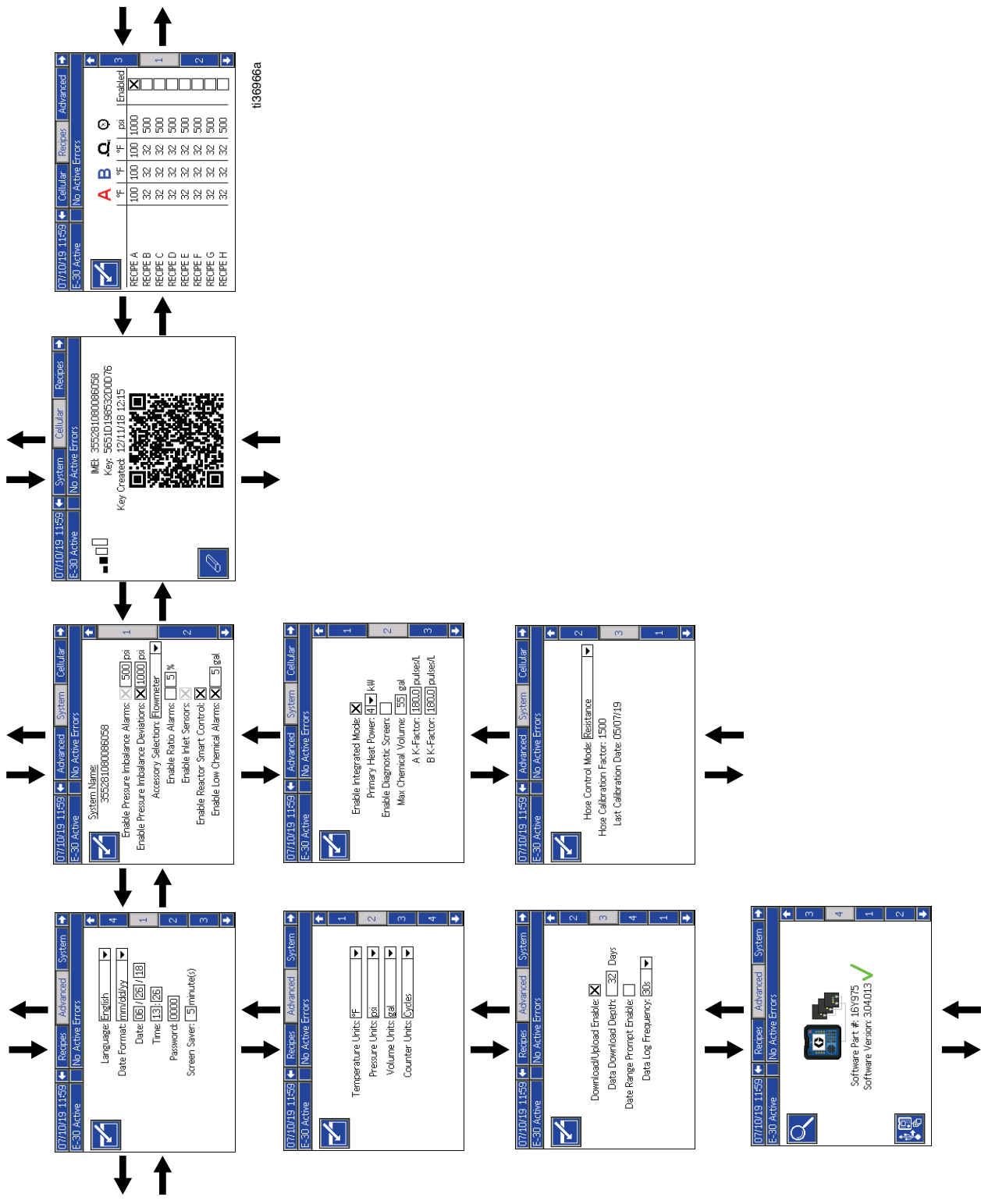

Fig. 13: Setup Screens Navigation Diagram

Advanced Setup Screens

Advanced setup screens enable users to set units, adjust values, set formats, and view software information for each component. Press



to scroll through the Advanced setup screens. Once in desired Advanced setup

screen, press to access the fields and make

changes. When changes are complete, press to

NOTE: User must be out of edit mode to scroll through the Advanced setup screens.

Advanced Screen 1 - General

Use this screen to set the language, date format, current date, time, setup screens password (0000 - for none) or (0001 to 9999), and screen saver delay (zero disables the screen saver).

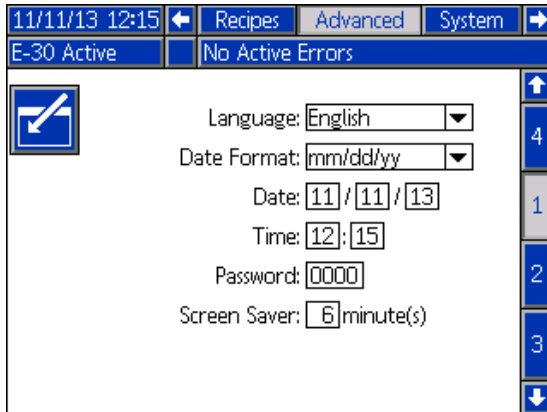

Advanced Screen 2 - Units

Use this screen to set the temperature units, pressure units, volume units, and cycle units (pump cycles or volume).

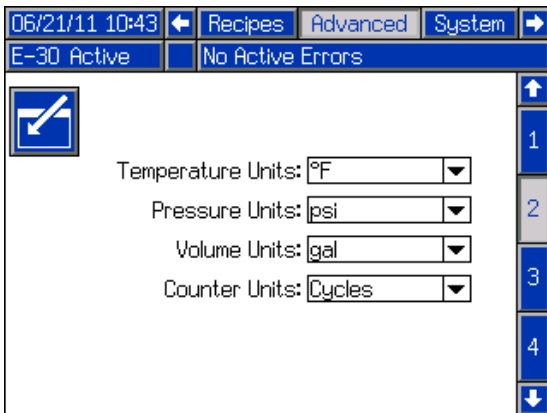

Advanced Screen 3 - USB

Use this screen to enable USB downloads/uploads, enable a logs 90% fully advisory, enter the maximum number of days to download data, enable specifying date range of data to download, and how frequently USB logs are recorded. See **USB Data**, page 66.

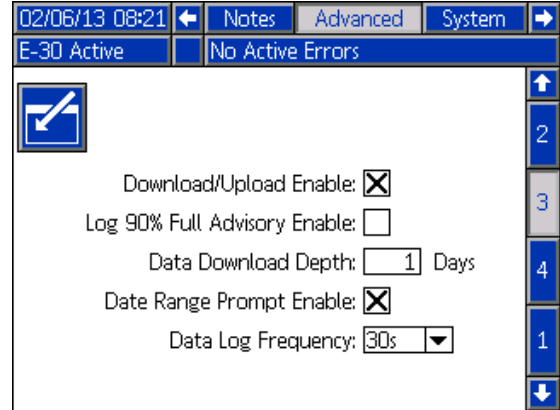

Advanced Screen 4 - Software

This screen displays the software part number. The software versions of the Advanced Display Module, Motor Control Module, Temperature Control Module, USB Configuration, Load Center, and Remote Display Module can be found by pressing the search soft key

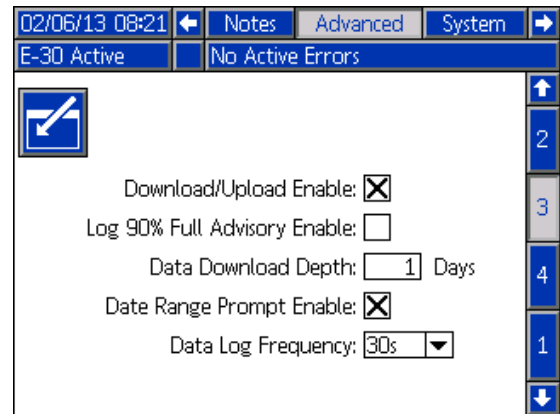

System 1

Use this screen to enable pressure imbalance alarms and deviations, set pressure imbalance values, enable inlet sensors, and enable low chemical alarms.

Select accessories using this screen. If the flow meter accessory is installed, use this screen to:

- Enable ratio errors.
- Set the ratio alarm percentage.
- Enable Reactor Smart Control.

12/11/18 12:13 Advanced System Cellular

E-30 Active No Active Errors

System Name: 355281080086058

Enable Pressure Imbalance Alarm: 500 psi

Enable Pressure Imbalance Deviation: 500 psi

Accessory Selection: Flowmeter

Enable Ratio Alarm: 5 %

Enable Inlet Sensors:

Enable Reactor Smart Control:

Enable Low Chemical Alarms: 5 gal

System 2

Use this screen to enable Integrated Mode and the diagnostic screen. This screen can also be used to set the primary heater size and the maximum drum volume.

Integrated Mode allows the Reactor to control an Integrates PowerStation, if the Integrated PowerStation is installed. If the flow meter accessory is installed, use this screen to set the k-factors. K-factors are printed on the flow meter serial number labels.

07/10/19 11:59 Advanced System Cellular

E-30 Active No Active Errors

Enable Integrated Mode:

Primary Heat Power: 4 kW

Enable Diagnostic Screen:

Max Chemical Volume: 55 gal

A K-Factor: 180.0 pulses/L

B K-Factor: 180.0 pulses/L

System 3

Use this screen to select Hose Control Mode and perform calibration. See **Hose Control Modes**, page 50, for information on the different hose control modes. Hose Resistance Mode can only be used if a calibration factor is stored. See **Calibration Procedure**, page 54.

07/10/19 11:59 Advanced System Cellular

E-30 Active No Active Errors

Hose Control Mode: Resistance

Hose Calibration Factor: 1500

Last Calibration Date: 05/07/19

Recipes

Use this screen to add recipes, view saved recipes, and enable or disable saved recipes. Enabled recipes can be selected at the Home Run Screen. 24 recipes can be displayed on the three recipe screens.

11/11/13 12:15 ← System Recipes Advanced →					
E-30 Active		No Active Errors			
	°F	°F	°F	psi	Enabled
RECIPE A	32	32	32	0	<input type="checkbox"/>
RECIPE B	32	32	32	0	<input type="checkbox"/>
RECIPE C	32	32	32	0	<input type="checkbox"/>
RECIPE D	32	32	32	0	<input type="checkbox"/>
RECIPE E	32	32	32	0	<input type="checkbox"/>
RECIPE F	32	32	32	0	<input type="checkbox"/>
RECIPE G	32	32	32	0	<input type="checkbox"/>
RECIPE H	32	32	32	0	<input type="checkbox"/>

Add Recipe

- Press and then use to select a recipe field. Press to enter a recipe name (maximum 16 characters). Press to clear the old recipe name.

11/08/11 13:52 ← System Recipes Advanced →																																																	
E-30 Active		No Active Errors																																															
Recipe Name																																																	
RECIPE B																																																	
<table border="1"> <tr> <td>1</td><td>2</td><td>3</td><td>4</td><td>5</td><td>6</td><td>7</td><td>8</td><td>9</td><td>0</td><td>-</td> </tr> <tr> <td>q</td><td>w</td><td>e</td><td>r</td><td>t</td><td>y</td><td>u</td><td>i</td><td>o</td><td>p</td><td></td> </tr> <tr> <td>a</td><td>s</td><td>d</td><td>f</td><td>g</td><td>h</td><td>j</td><td>k</td><td>l</td><td>;</td><td></td> </tr> <tr> <td>z</td><td>x</td><td>c</td><td>v</td><td>b</td><td>n</td><td>m</td><td>.</td><td>/</td><td></td><td></td> </tr> </table>						1	2	3	4	5	6	7	8	9	0	-	q	w	e	r	t	y	u	i	o	p		a	s	d	f	g	h	j	k	l	;		z	x	c	v	b	n	m	.	/		
1	2	3	4	5	6	7	8	9	0	-																																							
q	w	e	r	t	y	u	i	o	p																																								
a	s	d	f	g	h	j	k	l	;																																								
z	x	c	v	b	n	m	.	/																																									

- Use to highlight the next field and use the number pad to enter a value. Press to save.

Enable or Disable Recipes

- Press then use to select the recipe that needs to be enabled or disabled.
- Use to highlight the enabled check box. Press to enable or disable the recipe.

Cellular Screen

Use this screen to connect the Reactor 2 app to the Reactor, to determine the cellular signal strength, or to reset the Reactor Key.

07/10/19 11:59 ← System Cellular Recipes →		
E-30 Active		No Active Errors
<p>IMEI: 355281080086058 Key: 5651D198532D0D76 Key Created: 12/11/18 12:15</p>		

Reset Reactor Key



Resetting the Reactor Key prevents other users from remotely changing or viewing Reactor settings without first reconnecting to the Reactor.

- On the Reactor ADM Cellular Screen, press to reset the Reactor key.
- Press to confirm resetting the Reactor key.
- Reconnect the app to the Reactor. See Reactor 2 app installation manual.

NOTE: After resetting the Reactor key, all operators using the Graco Reactor 2 app must reconnect to the Reactor.

NOTE: For security of wireless control, change the Reactor key on a regular basis and whenever there is a concern about unauthorized access.

Run Mode

The ADM will start in the Run screens at the “Home” screen. Press   to navigate through the Run Mode screens.

From the Run screens, press  to access the Setup screens.

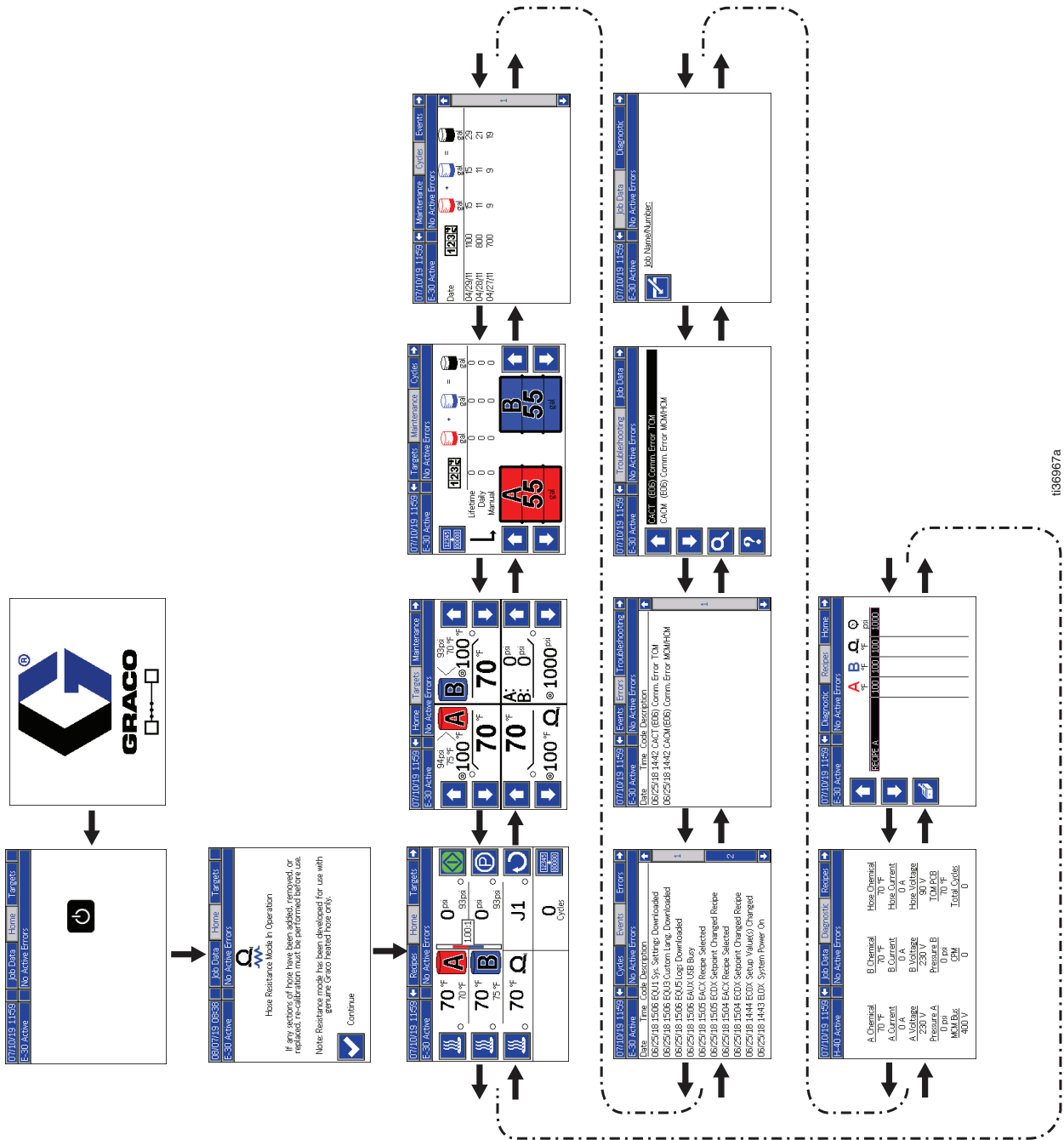
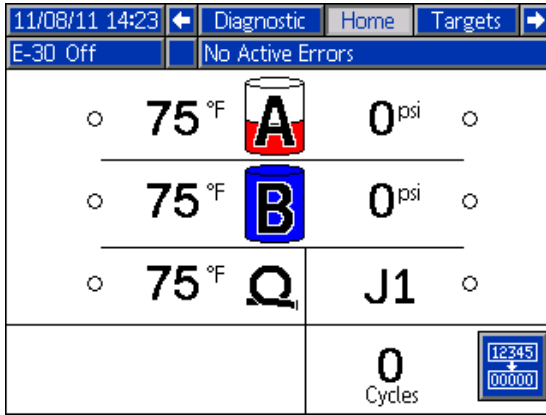

FIG. 14: Run Screens Navigation Diagram

Home Screen - System Off

This is the home screen when the system is off. This screen displays actual temperatures, actual pressures at the fluid manifold, jog speed, and number of cycles.



Home Screen - System Active

When the system is active, the home screen displays actual temperature for heat zones, actual pressures at the fluid manifold, coolant temperature, jog speed, the number of cycles, along with all associated control soft keys.

Use this screen to turn on heat zones, view coolant temperature, start the proportioner, stop the proportioner, park the component A pump, enter jog mode, and clear cycles.

NOTE: The screen shown displays inlet sensor temperatures and pressures. These will not be shown on models without inlet sensors.

NOTE: The screen show displays flow bars and the flow ratio. The vertical bars indicate the level of flow through the meters. The numerical ratio indicates the ratio of A-side component to B-side component (ISO:RES). For example, if the ratio is 1.10:1, the proportioner is pumping more A-side component (ISO) than B-side component (RES). If the ratio is 0.90:1, the proportioner is pumping more B-side component (RES) than A-side component (ISO).

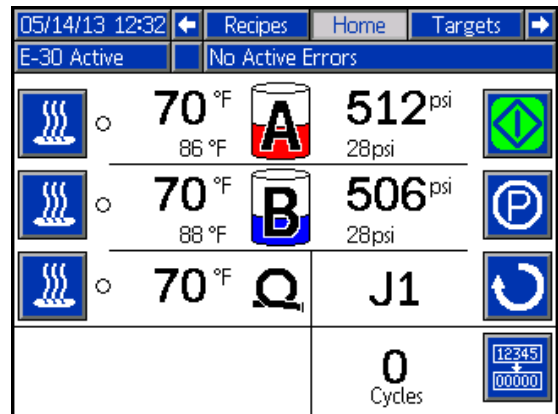

Home Screen - System With Error

Active errors are shown in the status bar. The error code, alarm bell, and description of the error will scroll in the status bar.

1. Press  to acknowledge the error.
2. See for corrective action.

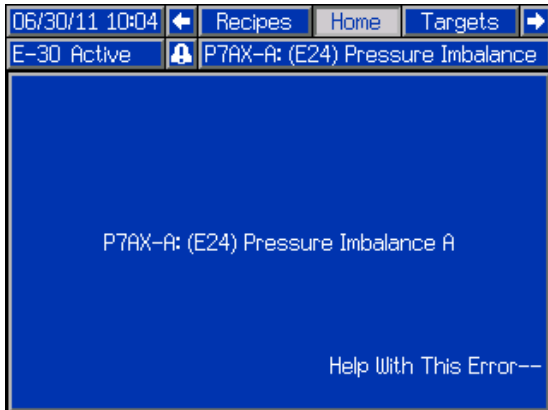

Targets Screen

Use this screen to define the setpoints for the A Component Temperature, B Component Temperature, heated hose temperature, and pressure.

Maximum A and B temperature: 190°F (88°C)

Maximum heated hose temperature: 10°F (5°C) above the highest A and B temperature setpoint or 180°F (82°C).

NOTE: If the remote display module kit is used, these setpoints can be modified at the gun.

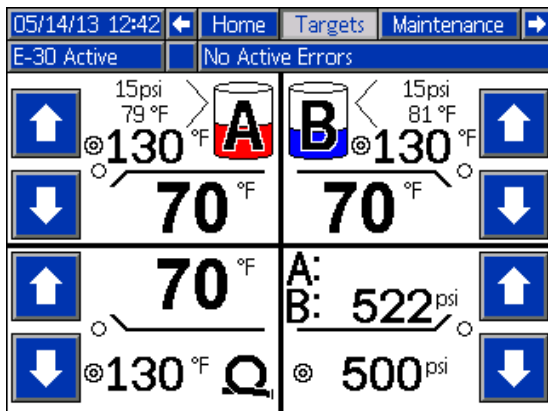

Maintenance Screen

Use this screen to view daily and lifetime cycles or gallons that have been pumped and gallons or liters remaining in the drums.

The lifetime value is the number of pump cycles or gallons since the first time the ADM was turned on.

The daily value automatically resets at midnight.

The manual value is the counter that can be manually

reset. Press  and hold to reset manual counter.

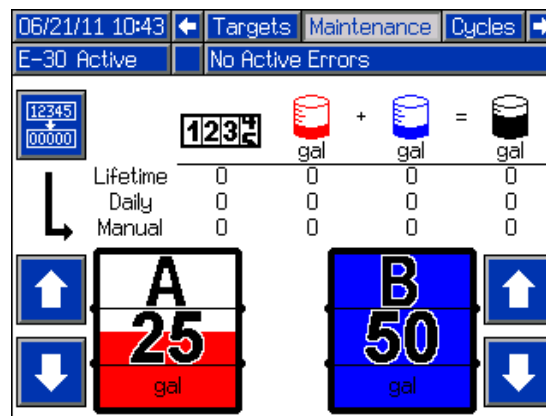

Cycles Screens

This screen shows daily cycles and gallons that have been sprayed for the day.

All information listed on this screen can be downloaded on a USB flash drive. See **Download Procedure**, page 66.

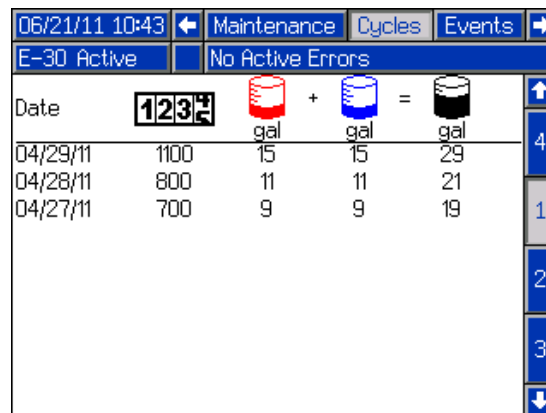

Events Screen

This screen shows the date, time, event code, and description of all events that have occurred on the system. There are 10 pages, each holding 10 events. The 100 most recent events are shown. See **System Events** for event code descriptions. See **Error Codes and Troubleshooting**, page 65, for error code descriptions.

All events and errors listed on this screen can be downloaded on a USB flash drive. To download logs, see **Download Procedure**, page 66.

06/21/11 10:43				Cycles	Events	Errors
E-30 Active				No Active Errors		
Date	Time	Code	Description			
06/21/11	10:47	EBDH	Heat Off Hose	8		
06/21/11	10:47	EBDB	Heat Off B	9		
06/21/11	10:47	EBDA	Heat Off A	10		
06/21/11	10:47	EBPX	Pump Off	1		
06/21/11	10:47	EADH	Heat On Hose	2		
06/21/11	10:47	EADB	Heat On B	3		
06/21/11	10:47	EADA	Heat On A	4		
06/21/11	10:46	EAPX	Pump On	5		
06/21/11	10:43	ELOX	System Power On	6		
06/21/11	10:42	EMOX	System Power Off	7		

Errors Screens

This screen shows the date, time, error code, and description of all errors that have occurred on the system.

All errors listed on this screen can be downloaded on a USB flash drive. See **Download Procedure**, page 66.





06/21/11 10:43				Errors	Troubleshooting
E-30 Active				No Active Errors	
Date	Time	Code	Description		
06/21/11	10:47	V1MH	Low Voltage Line Hose	8	
06/21/11	10:29	CACM (E06)	Comm. Error MCM	9	
06/21/11	10:26	WKBE	Fluid Solenoid Err. B Heat Ex.	10	
06/21/11	10:26	WKAE	Fluid Solenoid Err. A Heat Ex.	1	
06/21/11	10:26	CACM (E06)	Comm. Error MCM	2	
06/21/11	10:26	P7AX (E24)	Pressure Imbalance A	3	
06/21/11	10:24	WMOE	Radiator Fan Relay Err.	4	
06/21/11	10:24	WKBE	Fluid Solenoid Err. B Heat Ex.	5	
06/21/11	10:24	WKAE	Fluid Solenoid Err. A Heat Ex.	6	
06/21/11	10:24	WMOE	Radiator Fan Relay Err.	7	





Troubleshooting Screens

This screen displays the last ten errors that occurred on the system. Use the up and down arrows to select an

error and press  to view the QR code for the

selected error. Press  to access the QR code screen for an error code that is not listed on this screen. See **Error Codes and Troubleshooting**, page 65, for more information on error codes.

05/30/13 15:54		Troubleshooting	Job Data
E-30 Active		No Active Errors	
	H2MH	Low Frequency Hose	
	H2MB	Low Frequency B	
	H2MA	Low Frequency A	
	V2MH	Low Voltage Line Hose	
	V2MB	Low Voltage Line B	
	V2MA	Low Voltage Line A	
	V1CM (E26)	Low Voltage MCM	
	CACT (E06)	Comm. Error TCM	
	CACM (E06)	Comm. Error MCM	
	V1MH	Low Voltage Line Hose	

11/08/11 13:52		Troubleshooting	Diagnostic
E-30 Active		No Active Errors	
Enter 4 Character Error Code			
	1	2	3
	4	5	6
	7	8	9
	0	-	
	q	w	e
	r	t	y
	u	i	o
	p	a	s
	d	f	g
	h	j	k
	l	;	'
	z	x	c
	v	b	n
	m	,	.
	/		
			

QR Codes



To quickly view online help for a given error code, scan the displayed QR code with your smartphone. Alternately, visit help.graco.com and search for the error code to view online help for that code.

Diagnostic Screen

Use this screen to view information for all system components.

02/06/17 12:17			Job Data	Diagnostic	Home
E-30 Active		No Active Errors			
A Chemical	B Chemical	Hose Chemical			
70 °F	70 °F	70 °F			
A Current	B Current	Hose Current			
0 A	0 A	0 A			
TCM PCB					
70 °F					
A Voltage	B Voltage	Hose Voltage			
230 V	230 V	90 V			
Pressure A	Pressure B				
97 psi	82 psi				
MCM Bus	CPM	Total Cycles			
341 V	0	0			

The following information is displayed:

Temperature

- A Chemical
- B Chemical
- Hose Chemical
- TCM PCB - temperature control module temperature

Amps

- A Current H (0-25 A for 10kW heater, 0-38 A for 15 kW heater)
- B Current H (0-25 A for 10 kW heater, 0-38 A for 15 kW heater)
- Hose Current H (0-45 A typical)

Volts

- MCM BusH - displays the voltage supplied to the motor controller, which is the DC voltage that has been converted from the AC voltage supplied to the system (275-400 V typical full range)
- A Voltage - Voltage supplied to A heater (195-240 V typical)
- B Voltage - Voltage supplied to B heater (195-240 V typical)
- Hose Voltage (90V)

Pressure

- Pressure A - chemical
- Pressure B - chemical

Cycles

- CPM - cycles per minute
- Total Cycles - lifetime cycles

NOTE: H Maximum values based on maximum input voltage. Value will lower with lower input voltage.

Job Data Screen



11/11/13 12:14		Job Data	Recipes
E-30 Active		No Active Errors	
Job Name/Number:			
JOB 1			

Recipes Screen

Use this screen to select an enabled recipe. Use the up

and down arrows to highlight a recipe and press  to load. The currently loaded recipe is outlined by a green box.

NOTE: This screen will not display if there are not any enabled recipes. To enable and disable recipes, see **Enable or Disable Recipes**, page 35.

06/21/11 10:43		Diagnostic	Recipes	Home	
E-30 Active		No Active Errors			
  		A	B	Q	⊙
		°F	°F	°F	psi
	RECIPE A	180	180	180	2800
	RECIPE B	120	120	120	2000
	RECIPE C	100	100	100	1000
	RECIPE D	100	100	100	1500
	RECIPE E	100	100	100	2000
	RECIPE F	100	100	100	1750
	RECIPE G	100	100	100	1400
	RECIPE H	100	100	100	1200
	RECIPE I	110	110	110	1450
	RECIPE J	125	125	125	1100

System Events

Use the table below to find a description for all system non-error events. All events are logged in the USB log files.

Event Code	Description
EACX	Recipe Selected
EADA	Heat On A
EADB	Heat On B
EADH	Heat On Hose
EAPX	Pump On
EARX	Jog On
EAUX	USB Drive Inserted
EB0X	ADM Red Stop Button Pressed
EBDA	Heat Off A
EBDB	Heat Off B
EBDH	Heat Off Hose
EBPX	Pump Off
EBRX	Jog Off
EBUX	USB Drive Removed
EC0X	Setup Value Changed
ECDA	A Temperature Setpoint Changed
ECDB	B Temperature Setpoint Changed
ECDH	Hose Temperature Setpoint Changed
ECDP	Pressure Setpoint Changed
ECDX	Recipe Changed
EL0X	System Power On
EM0X	System Power Off
ENCH	Hose Calibration Updated
EP0X	Pump Parked
EQU1	System Settings Downloaded
EQU2	System Settings Uploaded
EQU3	Custom Language Downloaded
EQU4	Custom Language Uploaded
EQU5	Logs Downloaded
ER0X	User Counter Reset
EVUX	USB Disabled

Startup



To prevent serious injury, only operate Reactor with all covers and shrouds in place.

NOTICE

Proper system setup, startup, and shutdown procedures are critical to electrical equipment reliability. The following procedures ensure steady voltage. Failure to follow these procedures will cause voltage fluctuations that can damage electrical equipment and void the warranty.

1. Check fluid inlet filter screens. Before daily startup, ensure the fluid inlet screens are clean. See **Flush Inlet Strainer Screen**, page 62.

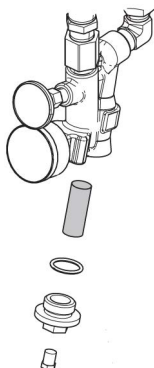

2. Check ISO lubrication reservoir. Check level and condition of ISO lube daily. See **Pump Lubrication System**, page 63.

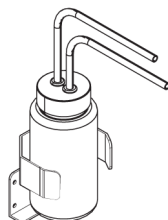

3. Use A and B Drum Level Sticks (24M174) to measure the material level in each drum. If desired, the level can be entered and tracked in the ADM. See **Advanced Setup Screens**, page 33.

4. Check generator fuel level.

NOTICE

Running out of fuel will cause voltage fluctuations that can damage electrical equipment and void the warranty. Do not run out of fuel.

5. Confirm main power switch if OFF before starting generator.

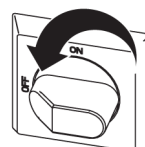

6. Ensure the main breaker on the generator is in the off position.

7. Start the generator. Allow it to reach full operating temperature.



8. Turn main power switch ON.



The ADM will display the following screen until communication and initialization is complete.



Startup

9. Switch on the air compressor, air dryer, and breathing air, if included.

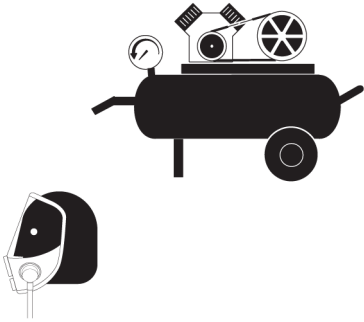

10. For first startup of new system, load fluid with feed pumps.

- a. Check that all **Setup** steps are complete. See **Setup**, page 26.
- b. If an agitator is used, open the agitator's air inlet valve.
- c. If you need to circulate fluid through the system to preheat the drum supply, see **Circulation Through Reactor**, page 46. If you need to circulate material through the heat hose to the gun manifold, see **Circulation Through Gun Manifold**, page 47.
- d. Turn both PRESSURE RELIEF/ SPRAY valves (SA, SB) to SPRAY

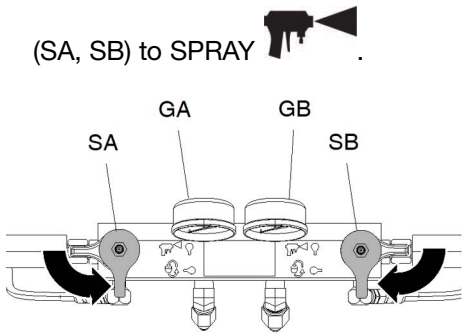

- e. Open fluid inlet valves (FV). Check for leaks.

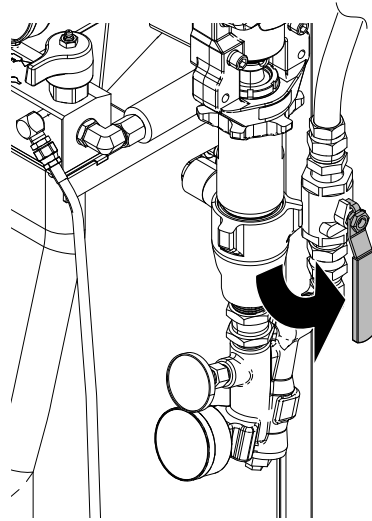

<p>Cross-contamination can result in cured material in fluid lines which could cause serious injury or damage equipment. To prevent cross-contamination:</p> <ul style="list-style-type: none"> • Never interchange component A and component B wetted parts. • Never use solvent on one side if it has been contaminated from the other side. • Always provide two grounded waste containers to keep component A and component B fluids separate. 				

- f. Hold gun fluid manifold over two grounded waste containers. Open fluid valves A and B until clean, air-free fluid comes from valves. Close valves.

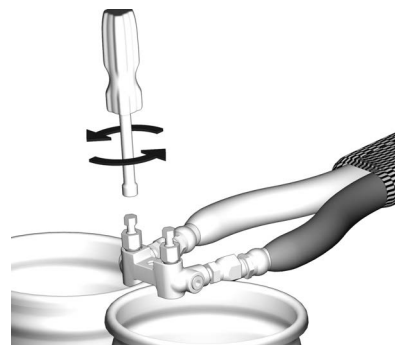

The Fusion AP gun manifold is shown.

11. Press  to active ADM.

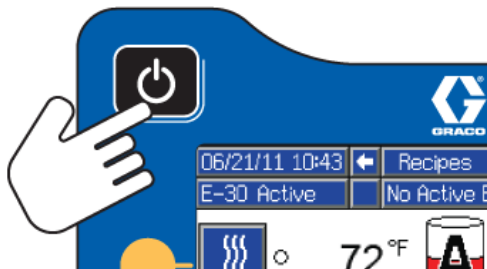



12. If necessary, setup the ADM in Setup Mode. See **Advanced Display Module (ADM) Operation**, page 30.

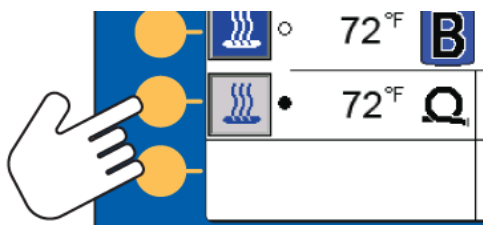

13. Preheat the system:

a. Press  to turn on hose heat zone.



NOTE: In order to run without a fluid temperature sensor in Hose Resistance Mode, a calibration factor must be saved. See **Calibration Procedure**, page 54.

				
<p>This equipment is used with heated fluid which can cause equipment surfaces to become very hot. To avoid severe burns:</p> <ul style="list-style-type: none"> Do not touch hot fluid or equipment. Do not turn on hose heat without fluid in hoses. Allow equipment to cool completely before touching it. Wear gloves if fluid temperature exceeds 100°F (43°C). 				

				
<p>Thermal expansion can cause overpressurization, resulting in equipment rupture and serious injury, including fluid injection. Do not pressurize system when preheating hose.</p>				

b. If you need to circulate fluid through the system to preheat the drum supply, see **Circulation Through Reactor**, page 46. If you need to circulate material through the heat hose to the gun manifold, see **Circulation Through Gun Manifold**, page 47.

c. Wait for the hose to reach set point temperature.

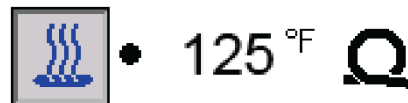

NOTE: Hose heat-up time may increase at voltages less than 230 VAC when maximum hose length is used.

d. Press  to turn on A and B heat zones.

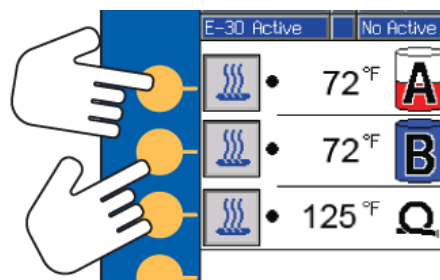

Fluid Circulation

Circulation Through Reactor

NOTICE
To prevent equipment damage, do not circulate fluid containing a blowing agent without consulting with the material supplier regarding fluid temperature limits.

NOTE: Optimum heat transfer is achieved at lower fluid flow rates with temperature set points at desired drum temperature. Low temperature rise deviation errors may result. To circulate through gun manifold and preheat hose, see **Circulation Through Gun Manifold**, page 47.

1. Follow **Startup**, page 43.

<p>To avoid injection injury and splashing, do not install shutoffs downstream of the PRESSURE RELIEF/SPRAY valve outlets (BA, BB). The valves function as overpressure relief valves when set to SPRAY . Lines must be open so valves can automatically relieve pressure when machine is operating.</p>				

2. See **Typical Installation, with system fluid manifold to drum circulation**, page 13. Route circulation lines back to respective component A or B supply drum. Use hoses rated at the maximum working pressure of this equipment. See **Technical Specifications**, page 73.

3. Set PRESSURE RELIEF/SPRAY valves (SA, SB) to

PRESSURE RELIEF/CALIBRATION

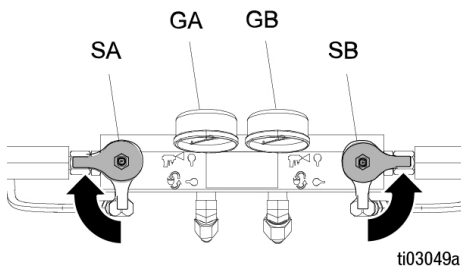

4. Set temperature targets. See **Targets Screen**, page 38.

5. Press to circulate fluid in jog mode until A and B temperatures reach targets. See **Jog Mode**, page 47, for more information about jog mode.

6. Press to turn on the hose heat zone.

7. Turn on the A and B heat zones. Wait until the fluid inlet valve temperature gauges (FV) reach the minimum chemical temperature from the supply drums.

8. Exit jog mode.

9. Set PRESSURE RELIEF/SPRAY valves (SA, SB) to

SPRAY

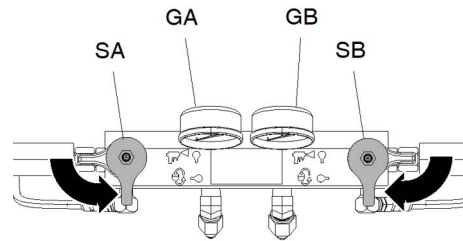

Circulation Through Gun Manifold

NOTICE

To prevent equipment damage, do not circulate fluid containing a blowing agent without consulting with the material supplier regarding fluid temperature limits.

NOTE: Optimum heat transfer is achieved at lower fluid flow rates with temperature set points at desired drum temperature. Low temperature rise deviation errors may result. Circulating fluid through the gun manifold allows rapid preheating of the hose.

1. Install gun fluid manifold (P) on accessory circulation kit (CK). Connect high pressure circulation lines (R) to circulation manifold.

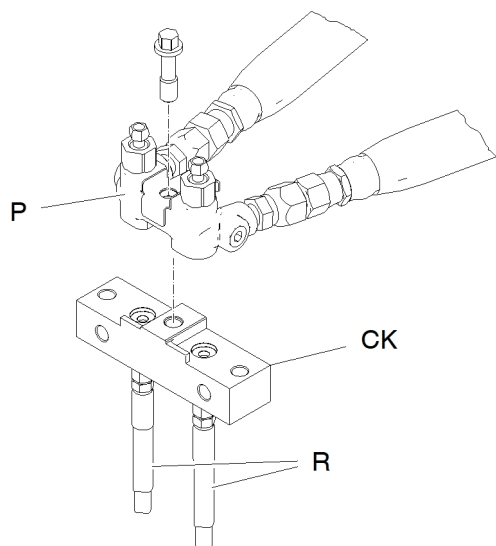

The Fusion AP gun manifold is shown.

CK	Gun	Manual
246362	Fusion AP	309818
256566	Fusion CS	313058

2. Route circulation lines back to respective component A or B supply drum. Use hoses rated at the maximum working pressure of this equipment. See **Technical Specifications**, page 73.
3. Follow procedures from **Startup**, page 43.
4. Turn main power switch ON.

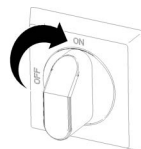

5. Set temperature targets. See **Targets Screen**, page 38.

6. Press  to circulate fluid in jog mode until A and B temperatures reach targets. See **Jog Mode**, page 47, for more information about jog mode.

Jog Mode

Jog mode has two purposes:

- It can speed fluid heating during circulation.
- It can ease system flushing and priming.

1. Turn main power switch ON.





2. Press circulate  to enter jog mode.

3. Press up or down   to change jog speed (J1 through J20).

NOTE: Jog speeds correlate to 3-30% of motor power, but will not operate over 700 psi (4.9 MPa, 49 bar) for either A or B.

4. Press  to start motor.

5. To stop the motor and exit jog mode, press  or .

Spraying



The Fusion AP gun is shown.

1. Engage gun piston safety lock then close fluid inlet valves A and B.

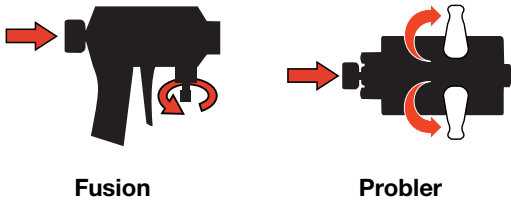

2. Attach gun fluid manifold. Connect gun air line. Open air line valve.

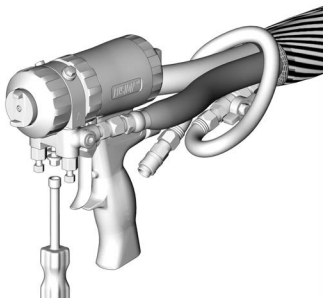

3. Adjust the gun air regulator to desired gun air pressure. Do not exceed the maximum rated air pressure.
4. Set PRESSURE RELIEF/SPRAY valves (SA, SB) to spray

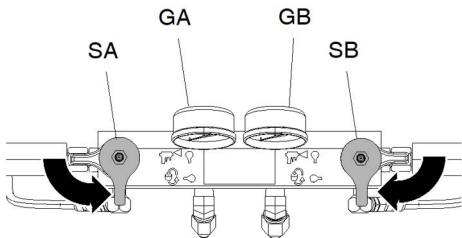

5. Verify heat zones are on and temperatures and pressures are on target, see **Home Screen**, page 37.

6. Open fluid inlet valve located at each pump inlet.

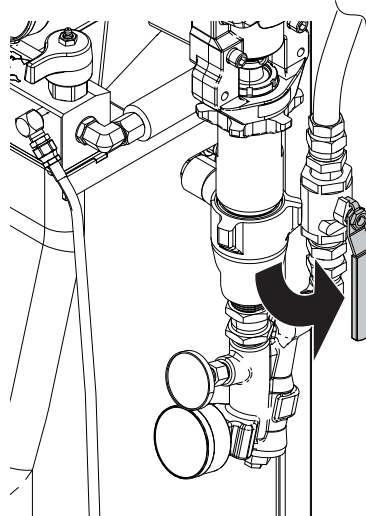

7. Press  to start motor and pumps.

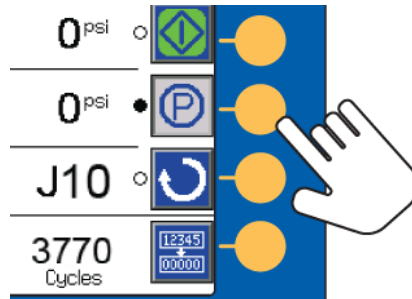

8. Check fluid pressure gauges (GA, GB) to ensure proper pressure balance. If imbalanced, reduce pressure of higher component by **slightly** turning PRESSURE RELIEF/SPRAY valve for that component toward PRESSURE

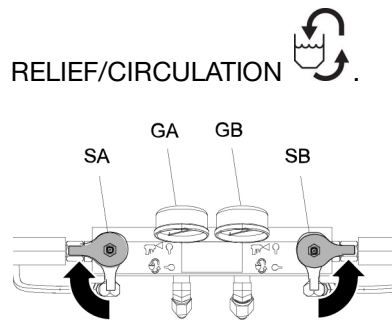

ti03049a

9. Open gun fluid inlet valves A and B.

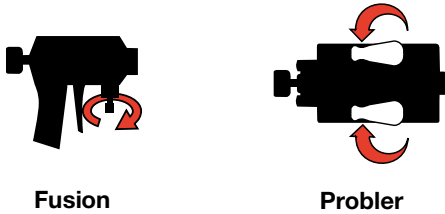

NOTICE

To prevent material crossover on impingement guns, **never** open fluid manifold valves or trigger gun if pressures are imbalanced.

10. Disengage gun piston safety lock.

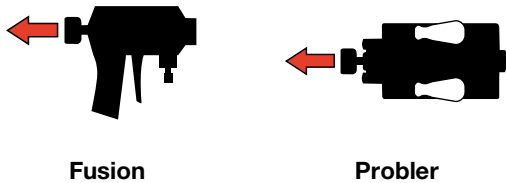



11. Pull gun trigger to test spray onto cardboard. If necessary, adjust pressure and temperature to get desired results.

Spray Adjustments

Flow rate, atomization, and amount of overspray are affected by four variables.

- **Fluid pressure setting.** Too little pressure results in an uneven pattern, coarse droplet size, low flow, and poor mixing. Too much pressure results in excessive overspray, high flow rates, difficult control, and excessive wear.
- **Fluid temperature.** Similar effects to fluid pressure setting. The A and B temperatures can be offset to help balance the fluid pressure.
- **Mix chamber size.** Choice of mix chamber is based on desired flow rate and fluid viscosity.
- **Clean-off air adjustment.** Too little clean-off air results in droplets building up on the front of the nozzle, and no pattern containment to control overspray. Too much clean-off air results in air assisted atomization and excessive overspray.

Hose Control Modes

				
<p>Hose FTS must be connected in all modes to reduce the risk of static sparking. Static sparking can cause fumes to ignite or explode. Grounding provides an escape wire for the electric current.</p>				

If the system produces the T6DH sensor error alarm or the T6DT sensor TCM alarm, use Hose Manual Mode until the hose RTD cable or FTS can be repaired, or use the Hose Resistance Mode with a properly saved calibration factor.

Do not use Hose Manual Mode for extended periods of time. The system performs best when used in Hose FTS Mode or Hose Resistance Mode. Only use Hose Resistance Mode with genuine Graco heated hoses.

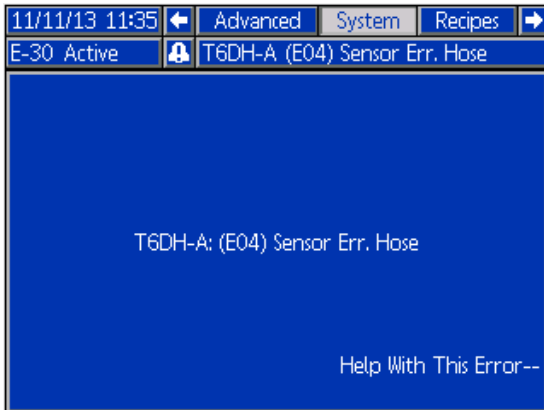

Hose Control Mode	Description
FTS	The fluid temperature sensor (FTS) installed in the hose automatically controls the hose fluid temperature. This mode requires the FTS to be installed and working properly.
Resistance	The hose heater element resistance automatically controls the hose fluid temperature. This mode requires a calibration factor (see Calibration Procedure , page 54).
Manual	The system supplies a set amount of hose current (amps) to heat the hose. The hose current is set by the user. This mode has no pre-programmed control and is designed to be used for a limited amount of time until the FTS issues are fixed, or a calibration factor is properly saved (see Calibration Procedure , page 54).

Enable Hose Resistance Mode

This mode requires a calibration factor to run (see **Calibration Procedure**, page 54).

1. Enter Setup Mode and navigate to System screen 3.

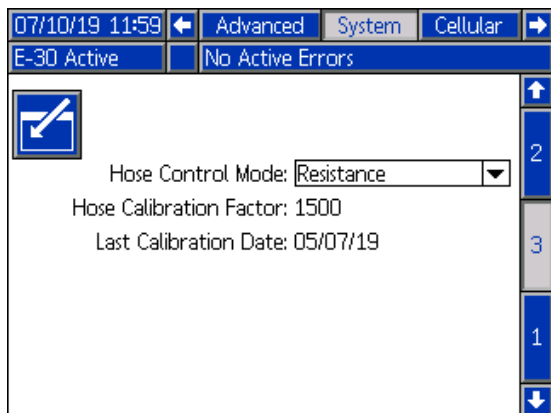

2. Select Resistance from the drop-down menu.

NOTE: If no calibration factor is shown, follow the **Calibration Procedure**, page 54.

NOTICE

To prevent damage to the heated hose, a hose calibration is required if any of the following conditions are true:

- The hose has never been calibrated before.
- A section of hose has been replaced.
- A section of hose has been added.
- A section of hose has been removed.

3. Enter Run Mode and navigate to the Targets screen. Use the up and down arrows to set the desired temperature.

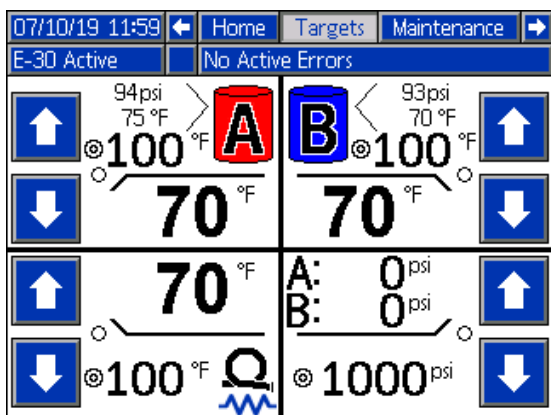

NOTE: Hose Resistance Mode controls the average fluid temperature of the A and B fluid. Set the hose temperature set point halfway between the A and B temperature set points and adjust as needed to achieve desired performance.

4. Navigate back to the Run Mode home screen. The Hose Resistance Mode icon will display.

NOTE: When Hose Resistance Mode is enabled and the hose heat is off, the hose temperature will display “- - -”. In Hose Resistance Mode, temperature values are only displayed when the heat is on.

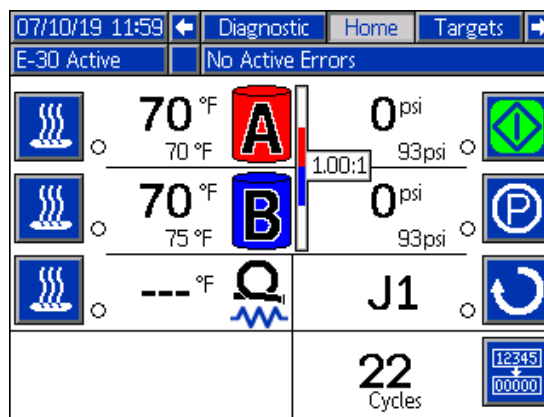

Disable Hose Resistance Mode

1. Enter Setup Mode.
2. Navigate to System Screen 3.
3. Set the Hose Control Mode to FTS.

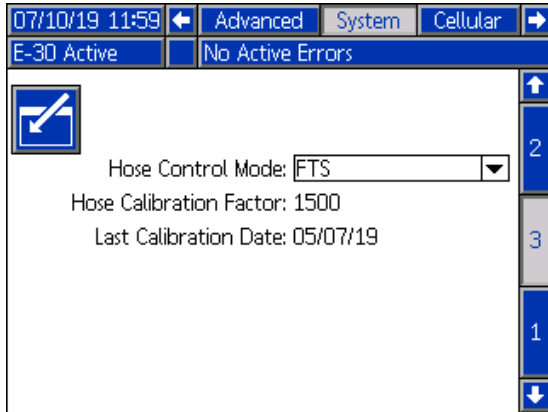

2. Set the Hose Control Mode to Manual.

NOTE: When manual hose mode is enabled, the manual hose mode advisory EVCH-V will appear.

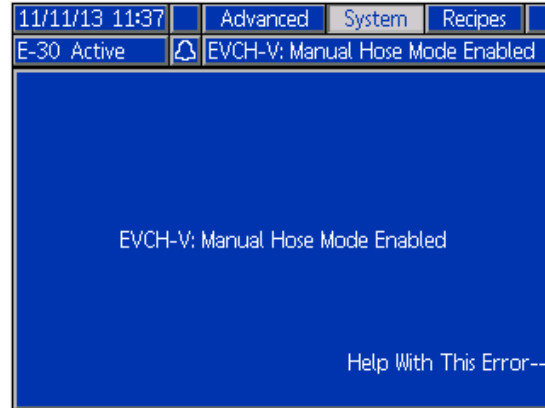

3. Enter Run Mode and navigate to the Target screen. Use the up and down arrows to set the desired hose current.

Enable Hose Manual Mode

1. Enter Setup Mode and navigate to System Screen 3.

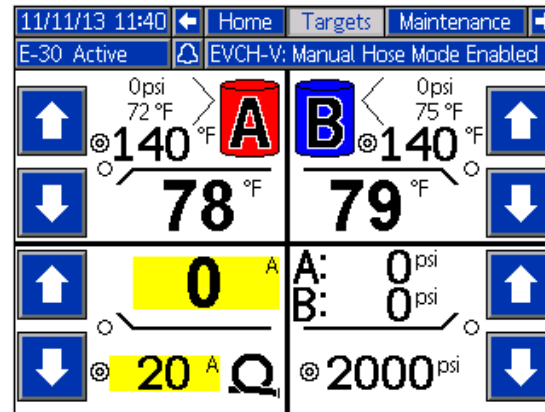
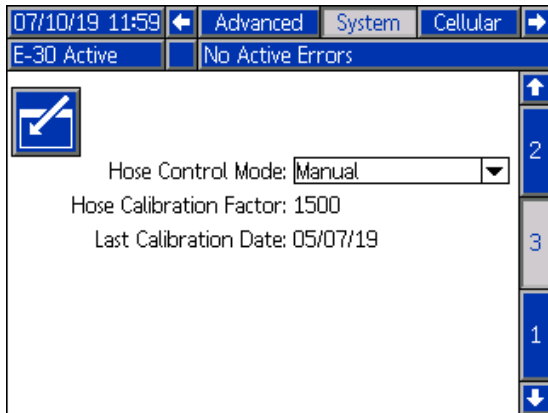

Hose Current Settings	Hose Current
Default	20A
Maximum	37A

4. Navigate back to the Run Mode Home screen. The hose now displays a current instead of a temperature.

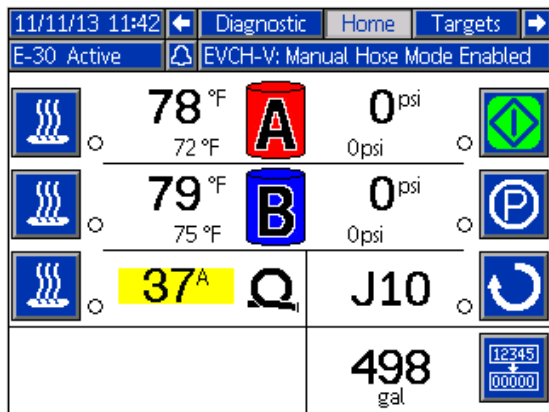

NOTE: Until the RTD sensor is repaired, the T6DH sensor error alarm will display each time the system is powered up.

Disable Hose Manual Mode

1. Enter Setup Mode.
2. Navigate to System Screen 3.
3. Set the Hose Control Mode to FTS or Resistance.

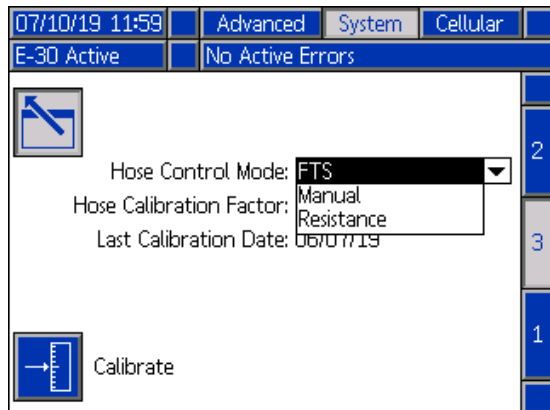

Calibration Procedure

NOTICE

To prevent damage to the heated hose, a hose calibration is required if any of the following conditions are true:

- The hose has never been calibrated before.
- A section of hose has been replaced.
- A section of hose has been added.
- A section of hose has been removed.

NOTE: The Reactor and heated hose must be at the same ambient temperature to get the most accurate calibration.

1. Enter Setup Mode and navigate to System Screen

3, then press the Calibrate soft key .

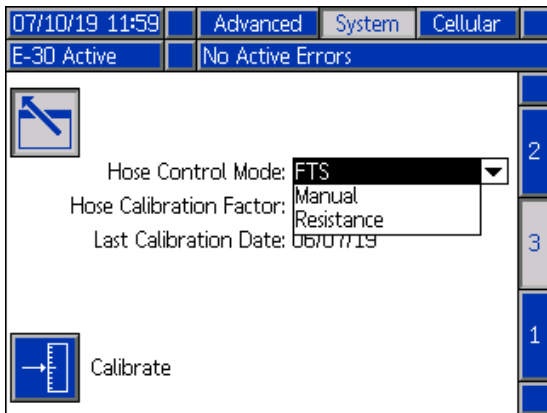

2. Press the Continue soft key  to acknowledge the reminder to have the hose at ambient conditions.

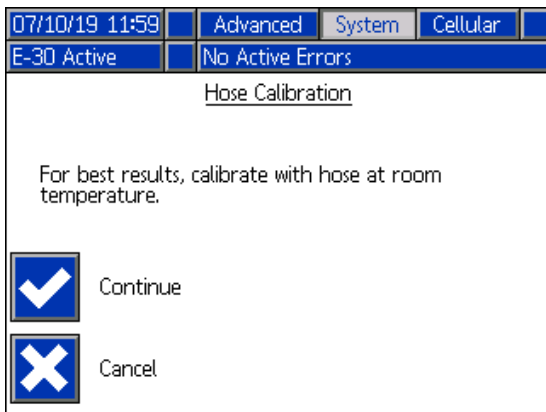

3. Wait while the system measures the hose resistance.

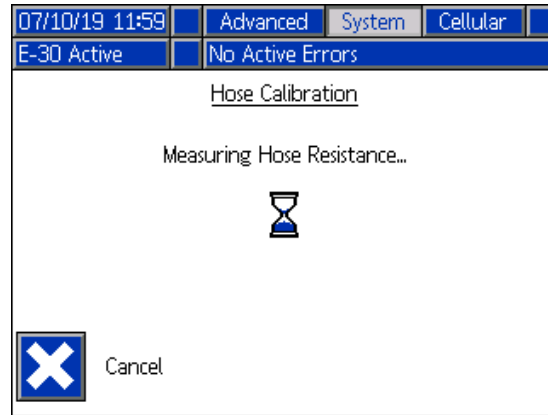

NOTE: If hose heat was on prior to the calibration procedure, the system will wait up to five minutes to allow the wire temperature to equalize.

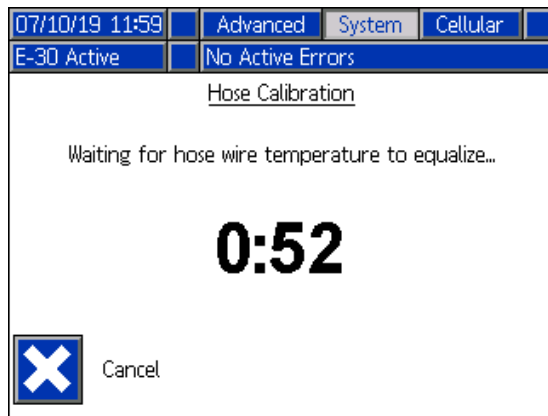

NOTE: The hose temperature must be above 32°F (0°C) during calibration.

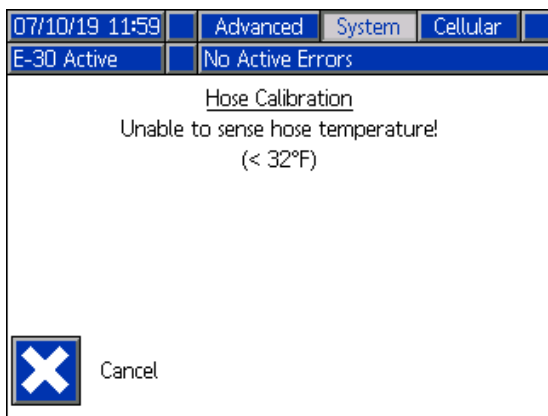

- Accept or cancel the hose calibration.

NOTE: A temperature estimate will be displayed if the system was able to measure the hose wire resistance.

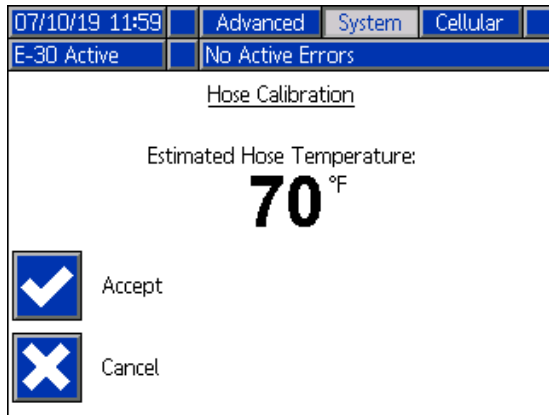

Shutdown

NOTICE

Proper system setup, startup, and shutdown procedures are critical to electrical equipment reliability. The following procedures ensure steady voltage. Failure to follow these procedures will cause voltage fluctuations that can damage electrical equipment and void the warranty.

- Press to stop the pumps.

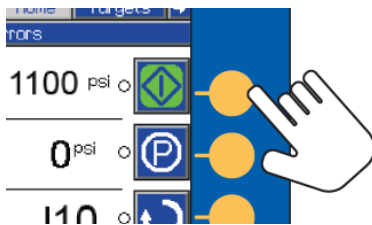

- Turn off all heat zones.

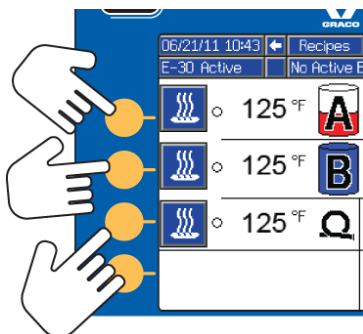

- Relieve pressure. See **Pressure Relief Procedure**, page 59.



- Press to part the Component A Pump. The park operation is complete when green dot goes away. Verify the park operation is complete before moving to the next step.

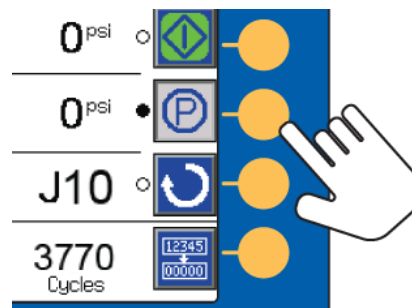

- Press to deactivate the system.

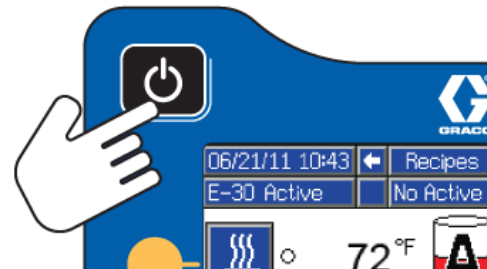

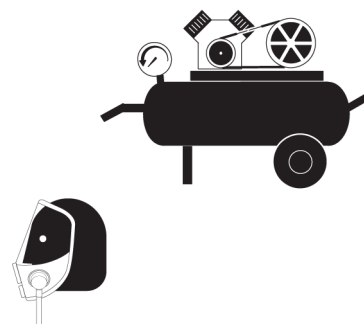

- Turn off the air compressor, air dryer, and breathing air.



Spraying

7. Turn main power switch OFF.



				
To prevent electric shock do not remove any covers or open the electrical enclosure door while the power is ON.				

8. Close all fluid supply valves.

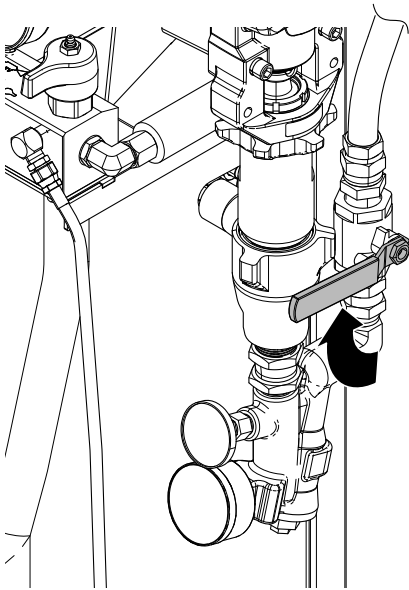

9. Set PRESSURE RELIEF/SPRAY valves (SA, SB) to SPRAY  to seal out moisture from drain line.

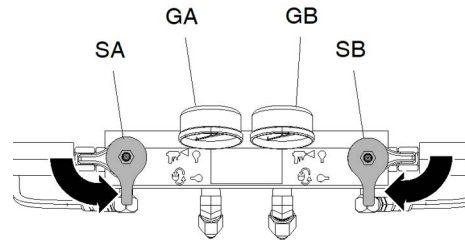

10. Engage gun piston safety lock then close fluid inlet valves A and B.

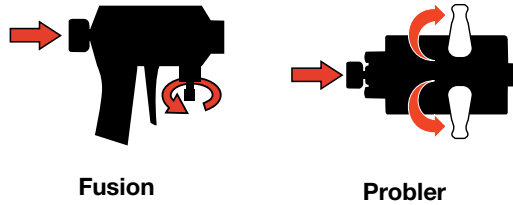

Purge Air Procedure



NOTE: Perform this procedure any time air is introduced into the system.

1. Relieve Pressure. See **Pressure Relief Procedure**, page 59.
2. Install a recirculation kit or install bleed lines between the outlet manifold recirculation fitting and a waste container.

NOTICE

To prevent equipment damage, do not circulate fluid containing a blowing agent without consulting the material supplier regarding fluid temperature limits.

3. Press the proportioner stop button  to turn off the motor.
4. To relieve air pressure from the feed pumps, disconnect the air supply lines (G) from the feed pumps (K).

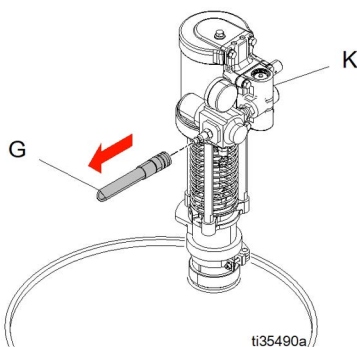

5. Set the PRESSURE RELIEF/SPRAY valves (SA, SB)

to PRESSURE RELIEF/CIRCULATION .

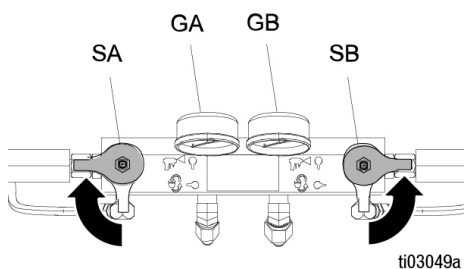

6. Adjust the pressure in the feed pump air supply lines to 100 psi.
7. To pressurize the feed pumps, connect the air supply lines (G) to the feed pumps (K).

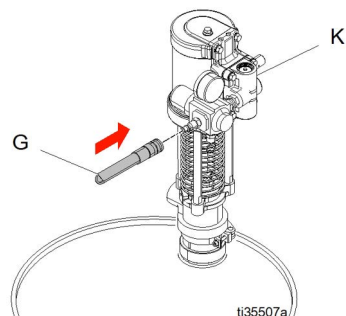

8. Press the jog mode button  to enter jog mode. Use   to set the jog speed to J20.

9. Press the jog mode start button  to start the motor. Run 1 gallon (3.8 L) of material through the system.

10. Set the PRESSURE RELIEF/SPRAY valves (SA, SB) to spray .

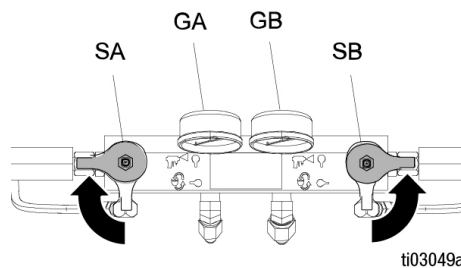

11. To relieve air pressure from the feed pumps, disconnect the air supply lines (G) from the feed pumps (K).

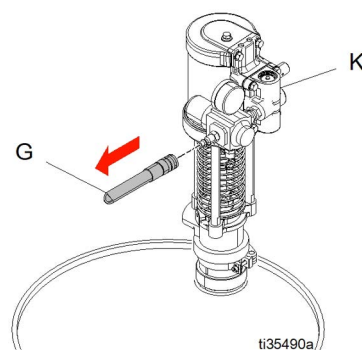

Spraying

12. Press the jog mode stop button  to exit jog mode.

13. Set the PRESSURE RELIEF/SPRAY valves (SA, SB)

to PRESSURE RELIEF/CALIBRATION .

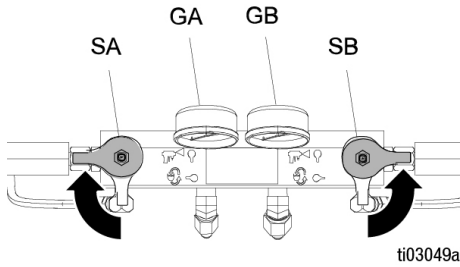

14. Listen for a “spitting” sound from the bleed lines (N) or recirculation lines (R). See **Typical Installation, without circulation**, page 12; **Typical Installation, with system fluid manifold to drum circulation**, page 13; and **Typical Installation, with gun fluid manifold to drum circulation**, page 14. This sound indicates the Reactor 2 system still contains unwanted air. If the system still contains air, repeat the purge air procedure.

Pressure Relief Procedure



Follow the Pressure Relief Procedure whenever you see this symbol.

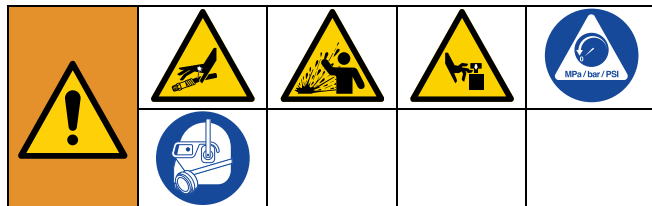

This equipment stays pressurized until pressure is manually relieved. To help prevent serious injury from pressurized fluid, such as skin injection, splashing fluid and moving parts, follow the Pressure Relief Procedure when you stop spraying and before cleaning, checking, or servicing the equipment.

The Fusion AP gun is shown.

1. Press to stop the pumps.
2. Turn off all heat zones.



3. Relieve pressure in gun and perform gun shutdown procedure. See your gun manual.
4. Close gun fluid inlet valves A and B.

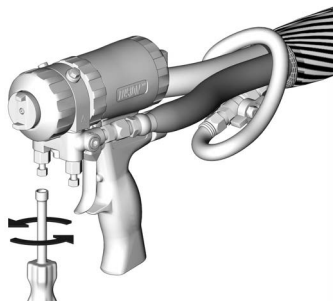

5. Shut off feed pumps and agitator, if used.
6. Route fluid to waste containers or supply tanks. Turn PRESSURE RELIEF/SPRAY valves (SA, SB) to

PRESSURE RELIEF/CIRCULATION . Ensure gauges drop to 0.

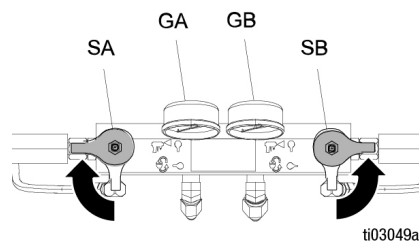

7. Engage gun piston safety lock.



8. Disconnect the gun air line and remove the gun fluid manifold.

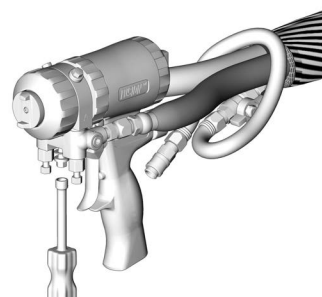

Flushing



To help prevent fire and explosion:

- Flush equipment only in a well-ventilated area.
- Do not spray flammable fluids.
- Do not turn on heaters while flushing with flammable solvents.
- Flush out old fluid with new fluid, or flush out old fluid with compatible solvent before introducing new fluid.
- Use the lowest possible pressure when flushing.
- All wetted parts are compatible with common solvents. Use only moisture-free solvents.

To flush feed hoses, pumps and heaters separately from heated hoses, set PRESSURE RELIEF/SPRAY valves (SA, SB) to PRESSURE RELIEF/CIRCULATION



. Flush through bleed lines (N).

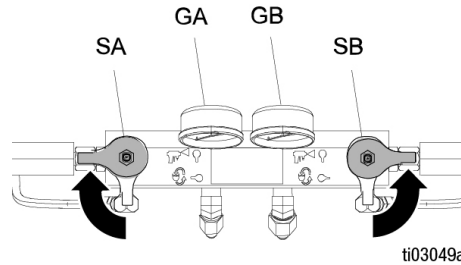

To flush entire system, circulate through gun fluid manifold (with manifold removed from gun).

To prevent moisture from reacting with isocyanate, always leave the system filled with a moisture-free plasticizer or oil. Do not use water. Never leave the system dry. See **Important Isocyanate Information**, page 6.

Maintenance



Prior to performing any maintenance procedures, follow **Pressure Relief Procedure**, page 59.

Preventative Maintenance Schedule

The operating conditions of this particular system determine how often maintenance is required. Establish a preventive maintenance schedule by recording when and what kind of maintenance is needed, and then determine a regular schedule for checking the system.

Proportioner Maintenance

Wet Cup

Check the wet cup daily. Keep it 2/3 full with Graco Throat Seal Liquid (TSL[®]) or compatible solvent. Do not overtighten packing nut/wet cup.

Packing Nuts

Do not overtighten packing nut/wet cup. Throat u-cup is not adjustable.

Fluid Inlet Strainer Screens

Inspect fluid inlet strainer daily, see **Fluid Inlet Strainer Screens**, page 61.

Grease Circulation Valves

Grease circulation valves (SA and SB) with Fusion grease (117773) weekly.

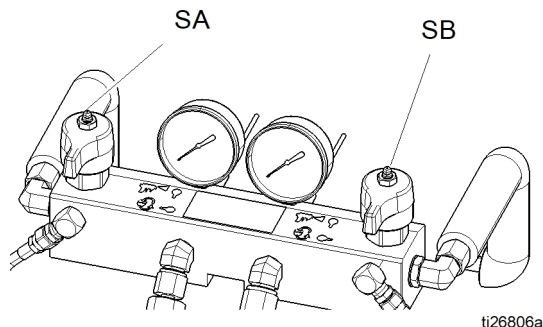

ISO Lubricant Level

Inspect ISO lubricant level and condition daily. Refill or replace as needed. See **Pump Lubrication System**, page 63.

Moisture

To prevent crystallization, do not expose component A to moisture in air.

Gun Mix Chamber Ports

Clean gun mix chamber ports regularly. See gun manual.

Gun Check Valve Screens

Clean gun check valve screens regularly. See gun manual.

Dust Protection

Use clean, dry, oil-free compressed air to prevent dust buildup on control modules, fans, and motor (under shield).

Vent Holes

Keep vent holes on bottom of electrical cabinet open.

Flush Inlet Strainer Screen



The inlet strainers filter out particles that can plug the pump inlet check valves. Inspect the screens daily as part of the startup routine, and clean as required.

Isocyanate can crystallize from moisture contamination or from freezing. If the chemicals used are clean and proper storage, transfer, and operating procedures are followed, there should be minimal contamination of the A-side screen.

Clean the A-side screen only during daily startup. This minimizes moisture contamination by immediately flushing out any isocyanate residue at the start of dispensing operations.

1. Close the fluid inlet valve at the pump inlet and shut off the appropriate feed pump. This prevents material from being pumped while cleaning the screen.
2. Place a container under the strainer base to catch drain off when removing the strainer plug (C).
3. Remove the screen (A) from the strainer manifold. Thoroughly flush the screen with compatible solvent and shake it dry. Inspect the screen. No more than 25% of the mesh should be restricted. If more than 25% of the mesh is blocked, replace the screen. Inspect the gasket (B) and replace as required.

4. Ensure the pipe plug (D) is screwed into the strainer plug (C). Install the strainer plug with the screen (A) and o-ring (B) in place and tighten. Do not overtighten. Let the gasket make the seal.
5. Open the fluid inlet valve, ensure there are no leaks, and wipe the equipment clean. Proceed with operation

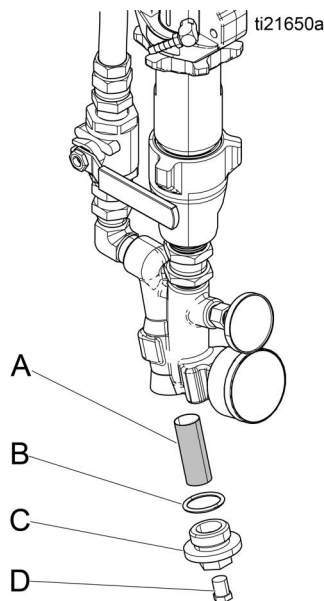

FIG. 15

Pump Lubrication System

Check the condition of the ISO pump lubricant daily. Change the lubricant if it becomes a gel, its color darkens, or it becomes diluted with isocyanate.

Gel formation is due to moisture absorption by the pump lubricant. The interval between changes depends on the environment in which the equipment is operating. The pump lubrication system minimizes exposure to moisture, but some contamination is still possible.

Lubricant discoloration is due to continual seepage of small amounts of isocyanate past the pump packings during operation. If the packings are operating properly, lubricant replacement due to discoloration should not be necessary more often than every three or four weeks.

To change pump lubricant:

1. Follow the **Pressure Relief Procedure**, page 59.
2. Lift the lubricant reservoir (R) out of the bracket and remove the container from the cap. Holding the cap over a suitable container, remove the check valve and allow the lubricant to drain. Reattach the check valve to the inlet hose.
3. Drain the reservoir and flush it with clean lubricant.

4. When the reservoir is flushed clean, fill with fresh lubricant.
5. Thread the reservoir onto the cap assembly and place it in the bracket.
6. Push the larger diameter supply tube (ST) approximately 1/3 of the way into the reservoir.
7. Push the smaller diameter return tube (RT) into the reservoir until it reaches the bottom.

NOTE: The return tube must reach the bottom of the reservoir to ensure the isocyanate crystals will settle to the bottom and not be siphoned into the supply tube and returned to the pump.

8. The lubrication system is ready for operation. No priming is required.

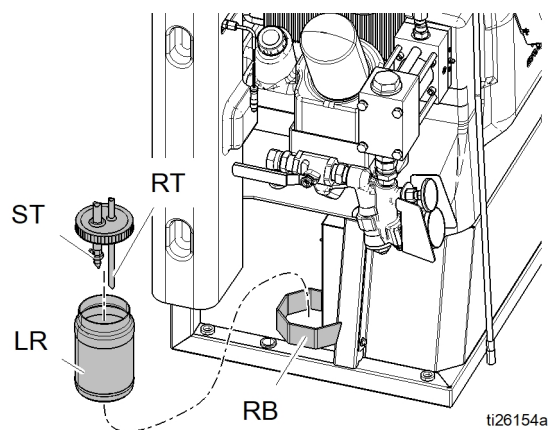

Errors

View Errors

When an error occurs the error information screen displays the active error code and description.

The error code, alarm bell, and active errors will scroll in the status bar. For a list of the ten most recent errors see **Troubleshooting**, page 65. Error codes are stored in the error log and displayed on the Error and Troubleshooting screens on the ADM.



There are three types of errors that can occur. Errors are indicated on the display as well as by the light tower (optional).

Alarms are indicated by . This condition indicates a parameter critical to the process has reached a level requiring the system to stop. The alarm needs to be addressed immediately.

Deviations are indicated by . This condition indicates a parameter critical to the process has reached a level requiring attention, but not sufficient enough to stop the system at this time.

Advisories are indicated by . This condition indicates a parameter that is not immediately critical to the process. The advisory needs attention to prevent more serious issues in the future.

To diagnose the active error, see **Troubleshooting Errors**, page 64.

Troubleshooting Errors

To troubleshoot the error:

1. Press the soft key next to “Help With This Error” for help with the active error.

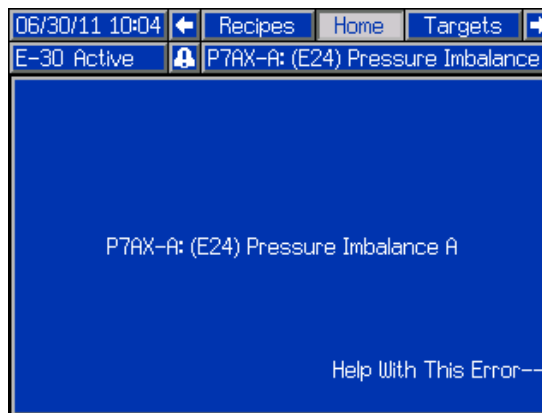







NOTE: Press  or  to return to the previously displayed screen.

2. The QR code screen will be displayed. Scan the QR code with your smart phone to be sent directly to online troubleshooting for the active error code. Otherwise, manually navigate to help.graco.com and search for the active error.



3. If no internet connection is available, see **Error Codes and Troubleshooting**, page 65, for causes and solutions for each error code.

Troubleshooting

				
				
<p>To avoid injury due to unexpected machine operation initiated by a remote control, disconnect the Reactor 2 app cellular module, if equipped, from the system prior to troubleshooting. Refer to the Reactor 2 App manual for instructions.</p>				

See **Errors**, page 64, for information about errors that can occur on the system.

See **Troubleshooting**, page 65, for the ten most recent errors that have occurred on the system. See **Troubleshooting Errors**, page 64, to diagnose errors on the ADM that have occurred on the system.

Error Codes and Troubleshooting

See system repair manual or visit help.graco.com for cause and solutions to each error code, or call your Graco contact listed on the back page of this manual.

USB Data

Download Procedure

NOTE: If log files are not correctly saving to the USB flash drive (for example, missing or empty log files), save desired data off of the USB flash drive and reformat it before repeating the download procedure.

NOTE: System configuration setting files and custom language files can be modified if the files are in the UPLOAD folder of the USB flash drive. See System Configuration Settings File, Custom Language File, and Upload Procedure sections.

1. Insert USB flash drive into USB port.
2. The menu bar and USB indicator lights indicate the USB is downloading files. Wait for USB activity to complete.
3. Remove USB flash drive from USB port.
4. Insert USB flash drive into USB port of computer.
5. The USB flash drive window automatically opens. If it does not, open USB flash drive from within Windows® Explorer.
6. Open GRACO folder.
7. Open the system folder. If downloading data for more than one system, there will be more than one folder. Each folder is labeled with the corresponding serial number of the ADM (The serial number is on the back of the ADM).
8. Open DOWNLOAD folder.
9. Open DATAxxxx folder.
10. Open DATAxxxx folder labeled with the highest number. The highest number indicated the most recent data download.
11. Open log file. Log files open in Microsoft Excel by default as long as the program is installed. However, they can also be opened in any text editor or Microsoft Word.

NOTE: All USB logs are saved in Unicode (UTF-16) format. If opening the log file in Microsoft Word, select Unicode encoding.

USB Logs

NOTE: The ADM can read/write to FAT (File Allocation Table) storage devices. NTFS, used by 32 GB or greater storage devices, is not supported.

During operation, the ADM stores system and performance related information to memory in the form of log files. The ADM maintain six log files

- Event Log
- Job Log
- Daily Log
- System Software Log
- Blackbox Log
- Diagnostics Log

Follow **Download Procedure**, page 66, to retrieve log files.

Each time a USB flash drive is inserted into the ADM USB port, a new folder named DATAxxxx is created. The number at the end of the folder name increases each time a USB flash drive is inserted and data is downloaded or uploaded.

Event Log

The event log file name is 1-EVENT.CSV and is stored in the DATAxxxx folder.

The event log maintains a record of the last 49,000 events and errors. Each event record contains:

- Date of event code
- Time of event code
- Event code
- Event type
- Action taken
- Event Description

Event codes include both error codes (alarms, deviations, and advisories) and record only events.

Actions Taken includes setting and clearing event conditions by the system, and acknowledging error conditions by the user.

Job Log

The job log file name is 2–JOB.CSV and is stored in the DATAxxxx folder.

The job log maintains a record of data points based on the USB Log Frequency defined in the Setup screens. The ADM stores the last 237,000 data points for download. See **Advanced Screen 3 - USB**, page 33, for information on setting the Download Depth and USB Log Frequency.

- Data point date
- Data point time
- A side temperature
- B side temperature
- Hose temperature
- A side temperature setpoint
- B side temperature setpoint
- Hose temperature setpoint
- A side inlet pressure
- B side inlet pressure
- Inlet pressure setpoint
- System lifetime pump cycle counts
- Pressure, volume, and temperature units
- Job name/number

Daily Log

The daily log file name is 3–DAILY.CSV and is stored in the DATAxxxx folder.

The daily log maintains a record of the total cycle and volume sprayed on any day that the system is powered up. The volume units will be the same units that were used in the Job Log.

The following data is stored in this file:

- Date and material sprayed
- Time - unused column
- Total pump cycle count for day
- Total volume sprayed for day

System Software Log

The system software file name is 4–SYSTEM.CSV and is stored in the DATAxxxx folder.

The system software log lists the following:

- Date log was created
- Time log was created
- Component name
- Software version loaded on the above component

Blackbox Log File

The black box file name is 5–BLACKB.CSV and is stored in the DATAxxxx folder.

The Blackbox log maintains a record of how the system runs and the features that are used. This log will help Graco troubleshoot system errors.

Diagnostic Log File

The diagnostics file name is 6–DIAGNO.CSV and is stored in the DATAxxxx folder.

The Diagnostics log maintains a record of how the system runs and the features that are used. This log will help Graco troubleshoot system errors.

System Configuration Settings

The system configuration settings file name is SETTINGS.TXT and is stored in the DOWNLOAD folder.

A system configuration settings file automatically downloads each time a USB flash drive is inserted into the ADM. Use this file to back up system settings for future recovery or to easily replicate settings across multiple systems. Refer to the **Upload Procedure**, page 68, for instructions on how to use this file.

Custom Language File

The custom language file name is DISPTXT.TXT and is stored in the DOWNLOAD folder.

A custom language file automatically downloads each time a USB flash drive is inserted into the ADM. If desired, use this file to create a user-defined set of custom language strings to be displayed within the ADM.

The system is able to display the following Unicode characters. For characters outside of this set, the system will display the Unicode replacement character, which appears as a white question mark inside of a black diamond.

- U+0020 - U+007E (Basic Latin)
- U+00A1 - U+00FF (Latin-1 Supplement)
- U+0100 - U+071F (Latin Extended-A)
- U+0386 - U+03CE (Greek)
- U+0400 - U+045F (Cyrillic)

Create Custom Language Strings

The custom language file is a tab-delimited text file that contains two columns. The first column consists of a list of strings in the language selected at the time of download. The second column can be used to enter the custom language strings. If a custom language was previously installed, this column contains the custom strings. Otherwise the second column is blank.

Modify the second column of the custom language file as needed and the follow **Upload Procedure**, page 68, to install the file. The format of the custom language file is critical. The following rules must be followed in order for the installation process to succeed.

- Define a custom string for each row in the second column.

NOTE: If the custom language file is used, you must define a custom string for each entry in the DISPTXT.TXT file. Blank second-column fields will be displayed blank on the ADM.

- The file name must be DISTEXT.TXT
- The file format must be a tab-delimited text file using Unicode (UTF-16) character representation.
- The file must contain only two columns, with columns separated by a single tab character.
- Do not add or remove rows to the file.
- Do not change the order of the rows.

Upload Procedure

Use this procedure to install a system configuration file and/or a custom language file.

1. If necessary, follow the **Download Procedure** to automatically generate the proper folder structure on the USB flash drive.
2. Insert USB flash drive into USB port of computer.
3. The USB flash drive window automatically opens. If it does not, open USB flash drive from within Windows Explorer.
4. Open GRACO folder.
5. Open the system folder. If working with more than one system, there will be more than one folder within the GRACO folder. Each folder is labeled with the corresponding serial number of the ADM (the serial number is on the back of the module).
6. If installing the system configuration settings file, place SETTINGS.TXT file into the UPLOAD folder.
7. If installing the custom language file, place DISPTXT.TXT file into the UPLOAD folder.
8. Remove USB flash drive from the computer.
9. Install USB flash drive into the ADM USB port.
10. The menu bar and USB indicator lights indicate the USB is downloading files. Wait for USB activity to complete.
11. Remove USB flash drive from USB port.

NOTE: If the custom language file was installed, users can now select the new language from the language drop-down menu in **Advanced Screen 1 - General**, page 33.

Performance Charts

Use these charts to help identify the proportioner that will work most efficiently with each mix chamber. Flow rates are based on a material viscosity of 60 cps.

NOTICE
To prevent system damage, do not pressurize the system above the line for the gun tip size being used.

Proportioners For Foam

Table 5: Foam Performance Chart

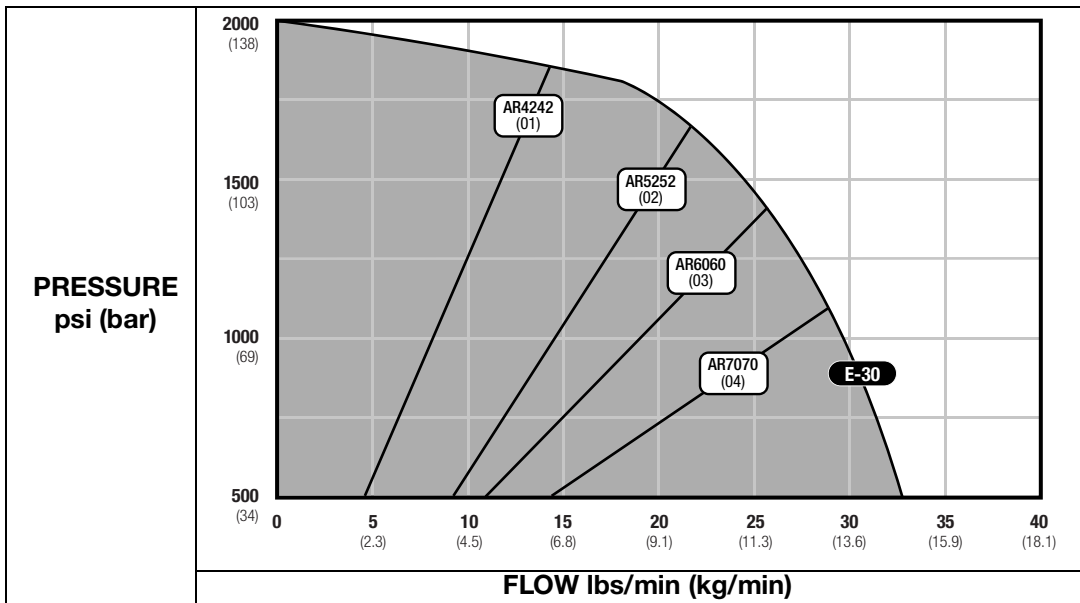

Proportioners For Coatings

Table 6: Fusion Air Purge, Round Pattern

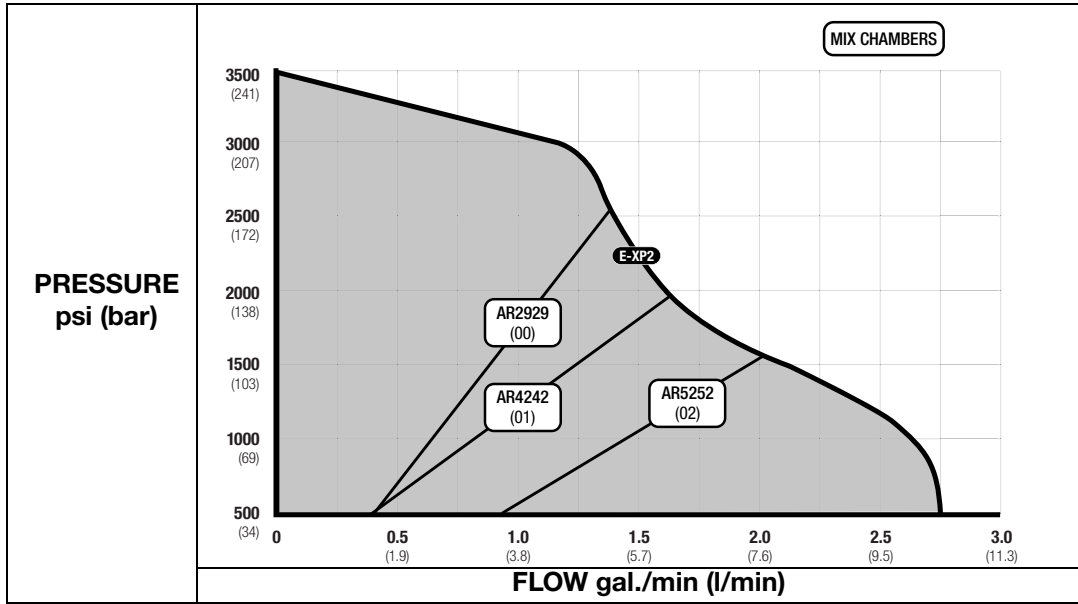

Table 7: Fusion Air Purge, Flat Pattern

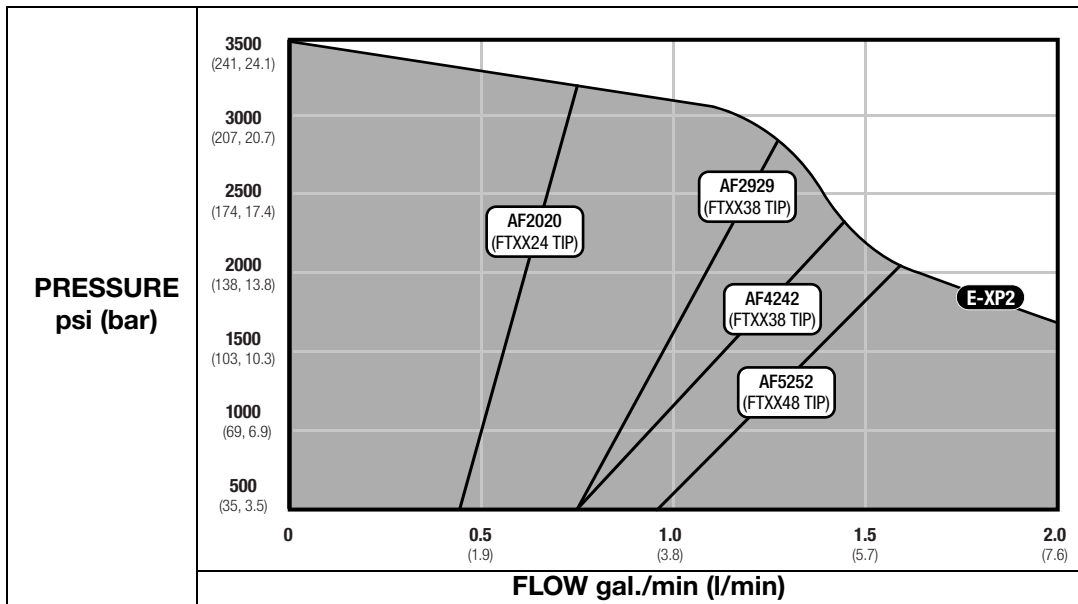

Table 8: Fusion Mechanical Purge, Round Pattern

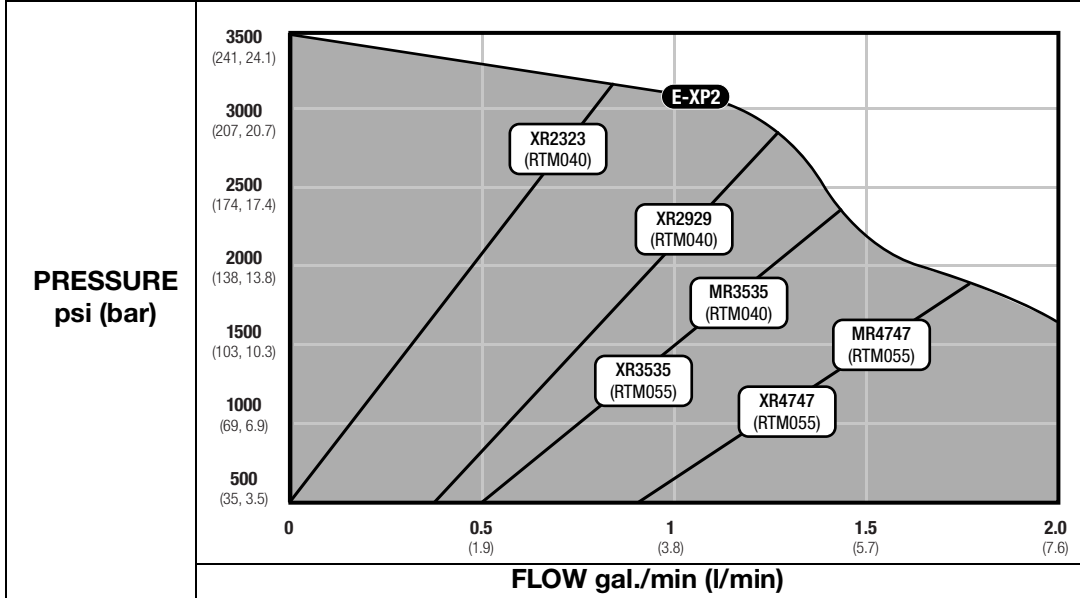
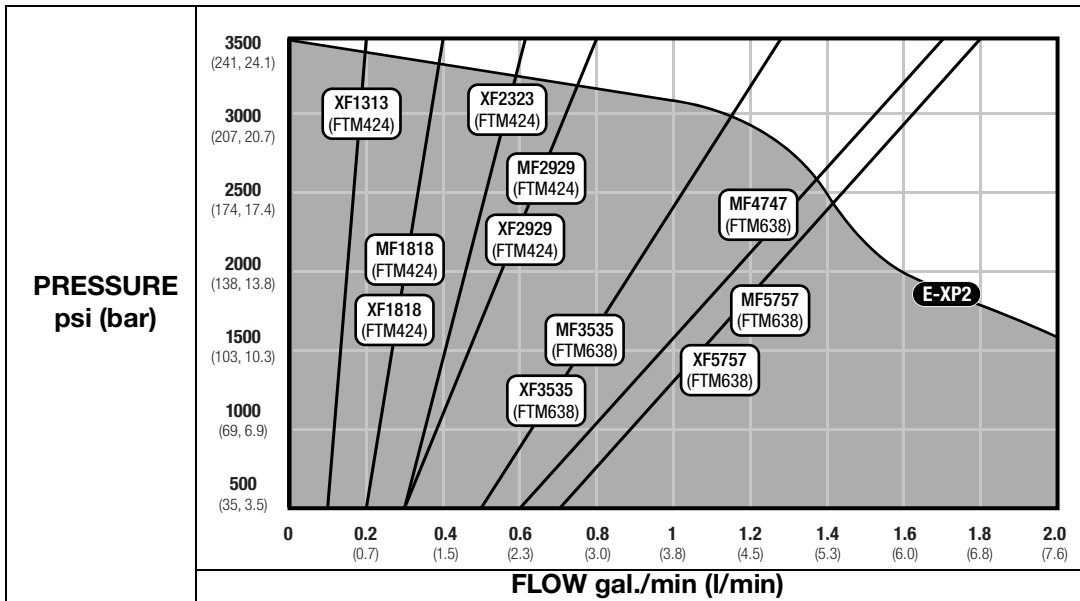
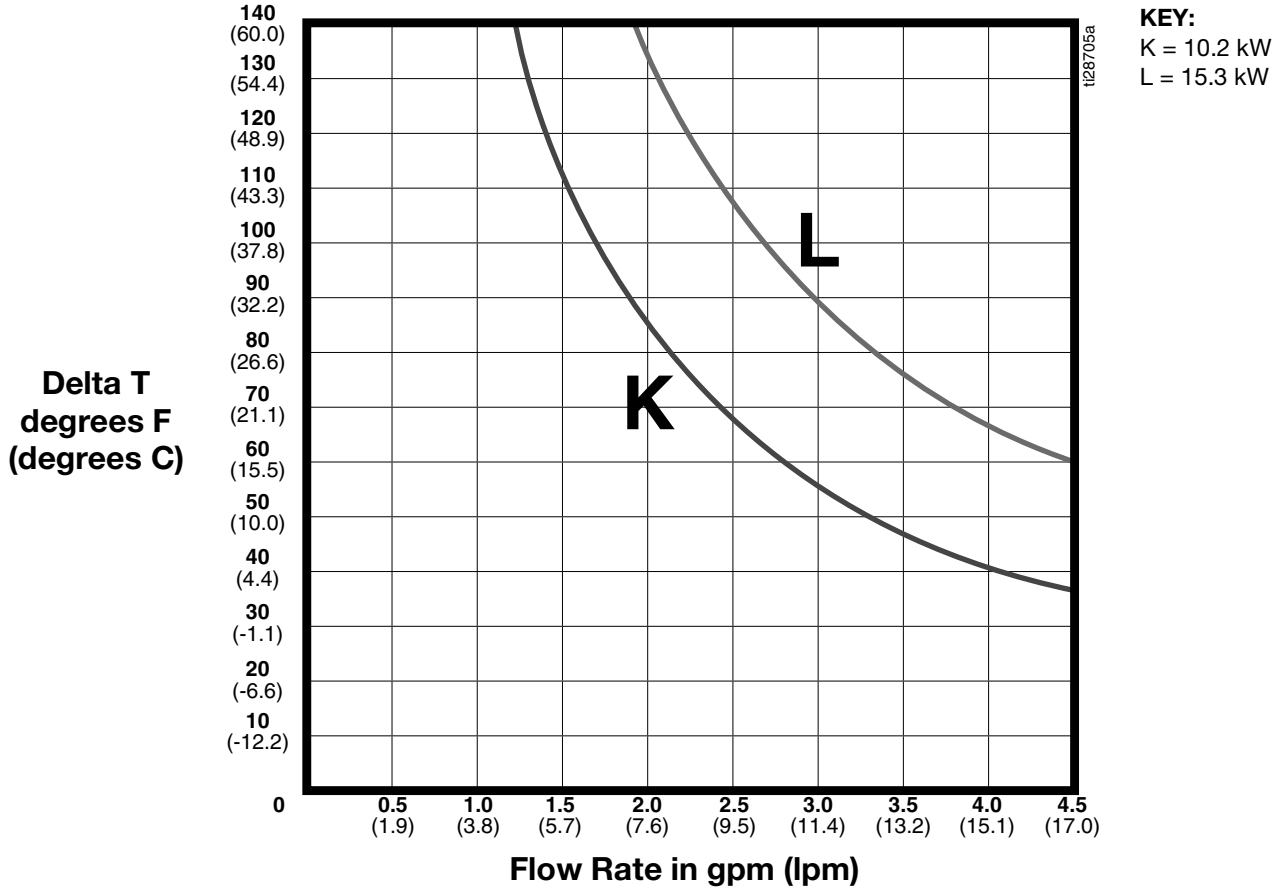

Table 9: Fusion Mechanical Purge, Flat Pattern



NOTE: Electric unit performance curves are based on typical operating conditions. Periods of continuous spraying or very high ambient temperatures reduce the performance envelope.

Heater Performance Chart



* Heater performance data is based on testing with 10 wt. hydraulic oil and 230V across heater power wires.

Technical Specifications

Reactor 2 E-30 and E-XP2 Proportioning System		
	US	Metric
Maximum Fluid Working Pressure		
E-30	2000 psi	14 MPa, 140 bar
E-XP2	3500 psi	24.1 MPa, 241 bar
Maximum Fluid temperature		
E-30	190°F	88°C
E-XP2	190°F	88°C
Maximum Flow Rate		
E-30	30 lb/min	13.5 kg/min
E-XP2	2 gpm	7.6 lpm
Maximum Heated Hose Length		
Length	310 ft	94 m
Output per Cycle, ISO and RES		
E-30	0.0272 gal.	0.1034 liter
E-XP2	0.0203 gal.	0.0771 liter
Operating Ambient Temperature Range		
Temperature	20° to 120°F	-7° to 49°C
Line Voltage Requirement		
Nominal 200-240 VAC, 1 Phase, 50/60 Hz	195-265 VAC	
Nominal 200-240 VAC, 3 phase, DELTA, 50/60 Hz	195-265 VAC	
Nominal 350-415 VAC, 3 phase, WYE, 50/60 Hz	340-455 VAC	
Heater Power (at 230 VAC)		
E-30, 10kW	10,200 Watts	
E-30, 15 kW	15,300 Watts	
E-XP2, 15kW	15,300 Watts	
Sound Pressure (measured per ISO-9614-2)		
E-30, <i>Measured from 3.1 ft (1 m), at 1000 psi (7 MPa, 70 bar), 3 gpm (11.4 lpm)</i>	87.3 dBA	
E-XP2, <i>Measured from 3.1 (1 m), at 3000 psi (21 MPa, 207 bar), 1 gpm (3.8 lpm)</i>	79.6 dBA	
Sound Power (measured per ISO-9614-2)		
E-30, <i>Measured from 3.1 ft (1 m), at 1000 psi (7 MPa, 70 bar), 3 gpm (11.4 lpm)</i>	93.7 dBA	
E-XP2, <i>Measured from 3.1 (1 m), at 3000 psi (21 MPa, 207 bar), 1 gpm (3.8 lpm)</i>	86.6 dBA	
Maximum Fluid Inlet Pressure		
Component A (ISO)	300 psi	2.1 MPa, 21 bar
Component B (RES)	300 psi	2.1 MPa, 21 bar
Fluid Inlets		
Component A (ISO) and Component B (RES)	3/4 npt(f) with 3/4 npsm(f) union	
Fluid Outlets		
Component A (ISO)	#8 (1/2 in.) JIC, with #5 (5/16 in.) JIC adapter	
Component B (RES)	#10 (5/8 in.) JIC, with #6 (3/8 in.) JIC adapter	

Reactor 2 E-30 and E-XP2 Proportioning System		
	US	Metric
Fluid Circulation Ports		
Size	1/4 npsm(m)	
Maximum Pressure	250 psi	1.75 MPa, 17.5 bar
Dimensions		
Width	23.6 in.	668 mm
Height	63 in.	1600 mm
Depth	15 in.	381 mm
Weight		
E-30, 10 kW	315 lb	143 kg
E-30, 15 kW	350 lb	159 kg
E-30, 10 kW Elite	320 lb	145 kg
E-30, 15 kW Elite	355 lb	161 kg
E-XP2	345 lb	156 kg
E-XP Elite	350 lb	159 kg
Wetted Parts		
Material	Aluminum, stainless steel, zinc plated carbon steel, brass, carbide, chrome, chemically resistant o-rings, PTFE, ultra-high molecular weight polyethylene	
Notes		
All trademarks or registered trademarks are the property of their respective owners.		

California Proposition 65

CALIFORNIA RESIDENTS

 **WARNING:** Cancer and reproductive harm – www.P65warnings.ca.gov.

Graco Extended Warranty for Reactor® 2 Components

Graco warrants all equipment referenced in this document which is manufactured by Graco and bearing its name to be free from defects in material and workmanship on the date of sale to the original purchaser for use. With the exception of any special, extended, or limited warranty published by Graco, Graco will, for a period of twelve months from the date of sale, repair or replace any part of the equipment determined by Graco to be defective. This warranty applies only when the equipment is installed, operated and maintained in accordance with Graco's written recommendations.

Graco Part Number	Description	Warranty Period
24U050 24U051	Electric Motor	36 Months or 3 Million Cycles
24U831	Motor Control Module	36 Months or 3 Million Cycles
24U832	Motor Control Module	36 Months or 3 Million Cycles
24U855	Heater Control Module	36 Months or 3 Million Cycles
24U854	Advanced Display Module	36 Months or 3 Million Cycles
All other Reactor 2 Parts		12 Months

This warranty does not cover, and Graco shall not be liable for general wear and tear, or any malfunction, damage or wear caused by faulty installation, misapplication, abrasion, corrosion, inadequate or improper maintenance, negligence, accident, tampering, or substitution of non-Graco component parts. Nor shall Graco be liable for malfunction, damage or wear caused by the incompatibility of Graco equipment with structures, accessories, equipment or materials not supplied by Graco, or the improper design, manufacture, installation, operation or maintenance of structures, accessories, equipment or materials not supplied by Graco.

This warranty is conditioned upon the prepaid return of the equipment claimed to be defective to an authorized Graco distributor for verification of the claimed defect. If the claimed defect is verified, Graco will repair or replace free of charge any defective parts. The equipment will be returned to the original purchaser transportation prepaid. If inspection of the equipment does not disclose any defect in material or workmanship, repairs will be made at a reasonable charge, which charges may include the costs of parts, labor, and transportation.

THIS WARRANTY IS EXCLUSIVE, AND IS IN LIEU OF ANY OTHER WARRANTIES, EXPRESS OR IMPLIED, INCLUDING BUT NOT LIMITED TO WARRANTY OF MERCHANTABILITY OR WARRANTY OF FITNESS FOR A PARTICULAR PURPOSE.

Graco's sole obligation and buyer's sole remedy for any breach of warranty shall be as set forth above. The buyer agrees that no other remedy (including, but not limited to, incidental or consequential damages for lost profits, lost sales, injury to person or property, or any other incidental or consequential loss) shall be available. Any action for breach of warranty hereunder must be brought within the latter of two (2) years of the date of sale, or one (1) year the warranty period expires.

GRACO MAKES NO WARRANTY, AND DISCLAIMS ALL IMPLIED WARRANTIES OF MERCHANTABILITY AND FITNESS FOR A PARTICULAR PURPOSE, IN CONNECTION WITH ACCESSORIES, EQUIPMENT, MATERIALS OR COMPONENTS SOLD BUT NOT MANUFACTURED BY GRACO. These items sold, but not manufactured by Graco (such as electric motors, switches, hose, etc.), are subject to the warranty, if any, of their manufacturer. Graco will provide purchaser with reasonable assistance in making any claim for breach of these warranties.

In no event will Graco be liable for indirect, incidental, special or consequential damages resulting from Graco supplying equipment hereunder, or the furnishing, performance, or use of any products or other goods sold hereto, whether due to a breach of contract, breach of warranty, the negligence of Graco, or otherwise.

FOR GRACO CANADA CUSTOMERS

The Parties acknowledge that they have required that the present document, as well as all documents, notices and legal proceedings entered into, given or instituted pursuant hereto or relating directly or indirectly hereto, be drawn up in English. Les parties reconnaissent avoir convenu que la rédaction du présente document sera en Anglais, ainsi que tous documents, avis et procédures judiciaires exécutés, donnés ou intentés, à la suite de ou en rapport, directement ou indirectement, avec les procédures concernées.

Graco Information

For the latest information about Graco products, visit www.graco.com.

For patent information, see www.graco.com/patents.

TO PLACE AN ORDER, contact your Graco distributor or call to identify the nearest distributor.

Toll Free Phone Number: 1-800-328-0211

*All written and visual data contained in this document reflects the latest product information available at the time of publication.
Graco reserves the right to make changes at any time without notice.*

Original instructions. This manual contains English. MM 333023

Graco Headquarters: Minneapolis

International Offices: Belgium, China, Japan, Korea

GRACO INC. AND SUBSIDIARIES • P.O. BOX 1441 • MINNEAPOLIS MN 55440-1441 • USA
Copyright 2021, Graco Inc. All Graco manufacturing locations are registered to ISO 9001.

www.graco.com
Revision V, October 2024