

3A1169B

EN

Interior Texture Sprayer TS900

For use with water based materials only. For professional use only.

Not approved to European explosive atmosphere requirements.

24F566

60 psi (.41 MPa, 4.1 bar) Maximum Fluid Working Pressure



Important Safety Instructions

Read all warnings and instructions in this manual. Save these instructions.

Related Manuals



311969



3A1171

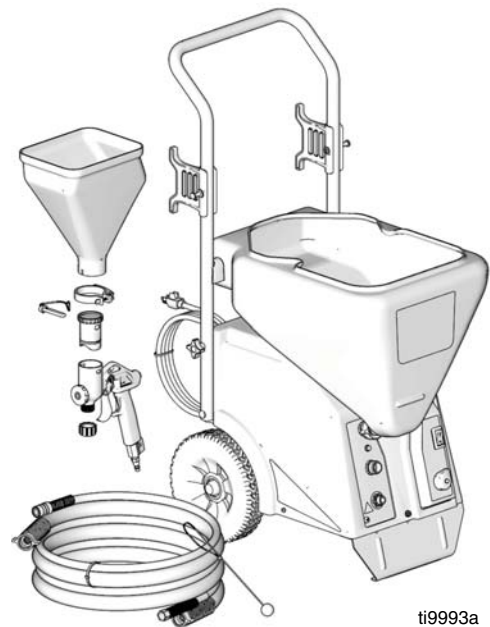

ti9993a

Warnings

The following warnings are for the setup, use, grounding, maintenance, and repair of this equipment. The exclamation point symbol alerts you to a general warning and the hazard symbols refer to procedure-specific risks. When these symbols appear in the body of this manual, refer back to these Warnings. Product-specific hazard symbols and warnings not covered in this section may appear throughout the body of this manual where applicable.

WARNING



GROUNDING

This product must be grounded. In the event of an electrical short circuit, grounding reduces the risk of electric shock by providing an escape wire for the electric current. This product is equipped with a cord having a grounding wire with an appropriate grounding plug. The plug must be plugged into an outlet that is properly installed and grounded in accordance with all local codes and ordinances.

- Improper installation of the grounding plug is able to result in a risk of electric shock.
- When repair or replacement of the cord or plug is required, do not connect the grounding wire to either flat blade terminal.
- The wire with insulation having an outer surface that is green with or without yellow stripes is the grounding wire.
- Check with a qualified electrician or serviceman when the grounding instructions are not completely understood, or when in doubt as to whether the product is properly grounded.
- Do not modify the plug provided; if it does not fit the outlet, have the proper outlet installed by a qualified electrician.
- This product is for use on a nominal 120V circuit and has a grounding plug similar to the plug illustrated in the figure below.

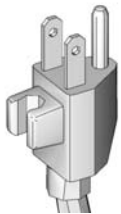

- Only connect the product to an outlet having the same configuration as the plug.
- Do not use an adapter with this product.

Extension Cords:

- Use only a 3-wire extension cord that has a 3-blade grounding plug and a 3-slot receptacle that accepts the plug on the product.
- Make sure your extension cord is not damaged. If an extension cord is necessary, use 12 AWG (2.5 mm²) minimum to carry the current that the product draws.
- An undersized cord results in a drop in line voltage and loss of power and overheating.

! WARNING



FIRE AND EXPLOSION HAZARD

Flammable fumes, such as solvent, in work area can ignite or explode. To help prevent fire and explosion:



- Use equipment in well ventilated area.
- Sprayer generates sparks. When flammable liquids are used near the sprayer or for flushing or cleaning, keep sprayer at least 20 feet (6 meters) away from explosive vapors.
- Keep work area free of debris, including solvent, rags and gasoline.
- Ground equipment in the work area. See **Grounding and Electrical Requirements, page 7**.
- If there is static sparking or you feel a shock, **stop operation immediately**. Do not use equipment until you identify and correct the problem.
- Keep a working fire extinguisher in the work area.



ELECTRIC SHOCK HAZARD

This equipment must be grounded. Improper grounding, setup, or usage of the system can cause electric shock.

- Turn off and disconnect power cord before servicing equipment.
- Use only grounded electrical outlets.
- Use only 3-wire extension cords.
- Ensure ground prongs are intact on power and extension cords.
- Do not expose to rain. Store indoors.



PRESSURIZED EQUIPMENT HAZARD

Fluid from the gun/dispense valve, leaks, or ruptured components can splash in the eyes or on skin and cause serious injury.

- Follow the **Pressure Relief Procedure, page 7** when you stop spraying and before cleaning, checking, or servicing equipment.
- Tighten all fluid connections before operating the equipment.
- Check hoses, tubes, and couplings daily. Replace worn or damaged parts immediately.

! WARNING



EQUIPMENT MISUSE HAZARD

Misuse can cause death or serious injury.

- Always wear appropriate gloves, eye protection, and a respirator or mask when painting.
- Do not operate or spray near children. Keep children away from equipment at all times.
- Do not overreach or stand on an unstable support. Keep effective footing and balance at all times.
- Stay alert and watch what you are doing.
- Do not leave the unit energized or under pressure while unattended. When the unit is not in use, turn off the unit and follow the **Pressure Relief Procedure, page 7** for turning off the unit.
- Do not operate the unit when fatigued or under the influence of drugs or alcohol.
- Do not kink or over-bend the hose.
- Do not expose the hose to temperatures or to pressures in excess of those specified by Airlessco.
- Do not use the hose as a strength member to pull or lift the equipment.



PLASTIC PARTS CLEANING SOLVENT HAZARD

Many solvents can degrade plastic parts and cause them to fail, which could cause serious injury or property damage.

- Use only compatible water-based solvents to clean plastic structural or pressure-containing parts.
- See **Technical Data** in this and all other equipment instruction manuals. Read fluid and solvent manufacturer's MSDSs and recommendations.



BURN HAZARD

Equipment surfaces and fluid that's heated can become very hot during operation. To avoid severe burns:

- Do not touch hot fluid or equipment.



MOVING PARTS HAZARD

Moving parts can pinch, cut or amputate fingers and other body parts.



- Keep clear of moving parts.
- Do not operate equipment with protective guards or covers removed.
- Pressurized equipment can start without warning. Before checking, moving, or servicing equipment, follow the **Pressure Relief Procedure, page 7** and disconnect all power sources.



PERSONAL PROTECTIVE EQUIPMENT

You must wear appropriate protective equipment when operating, servicing, or when in the operating area of the equipment to help protect you from serious injury, including eye injury, hearing loss, inhalation of toxic fumes, and burns. This equipment includes but is not limited to:

- Protective eyewear, and hearing protection.
- Respirators, protective clothing, and gloves as recommended by the fluid and solvent manufacturer.

NOTICE

Water or material remaining in unit when temperatures are below freezing can damage motor and/or delay pump startup. Do not allow unit to freeze.

General Information

Before adding material or starting unit in cold weather, run warm water through pump.

To ensure water and material are completely drained out of unit:

1. Remove material line from sprayer.
2. Tip sprayer up as shown.

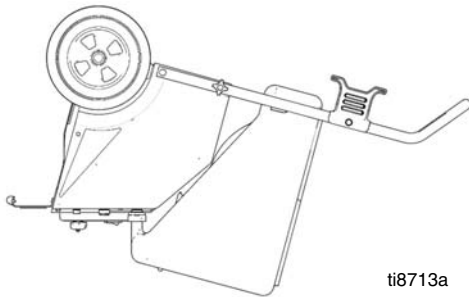

Before adding material to the hopper, install the burp guard (J). When only a small amount of material remains in the hopper, the burp guard prevents material from shooting out when the unit is turned off. This material could splash in the operator's eyes or on skin, or into the air.

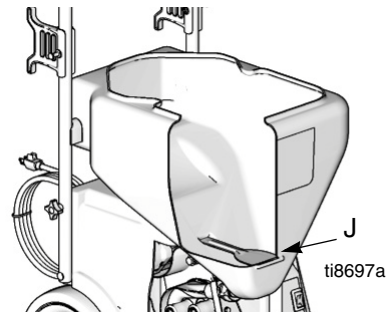

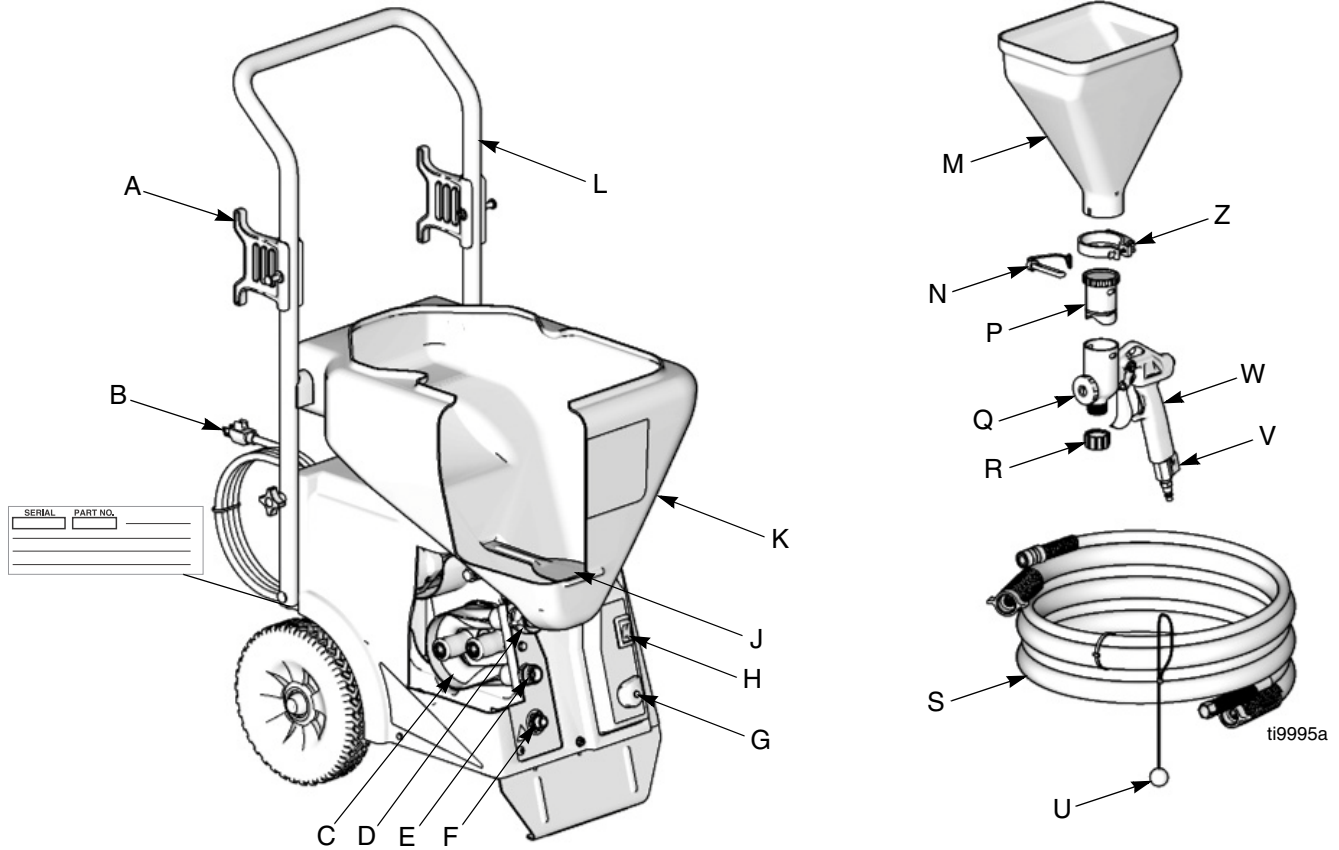

Component Identification



Item	Component	Item	Component
A	Hose Rack/Cord Wrap	M	Touch-Up Hopper (3/4 Gallon)
B	Power Cord	N	Gun Plug Clip
C	RotoFlex™ II Pump (inside)	P	Gun Plug
D	Hopper Fitting (fluid inlet)	Q	Nozzle (Nozzle Selection, page 13)
E	Material Hose Outlet	R	Hose Plug
F	Air Hose Outlet	S	Material/Air Hose
G	TS900 - Hopper Gun/Spray Selector Switch	U	Material Thickness Gauge
H	ON/OFF Switch	V	Gun Air Flow Control Valve
J	Burp Guard	W	Texture Spray Gun (manual 311969)
K	TS900 - Material Hopper, 8 Gallon	Z	Hopper Clamp
L	Handle		

Preparation

Pressure Relief Procedure

		
<p>To reduce risk of injury, follow this procedure whenever you see this symbol throughout this manual, Also, perform this procedure whenever you:</p> <ul style="list-style-type: none"> • Stop spraying • Check or repair any part of this system • Install or clean spray nozzle 		



1. Turn Power Switch OFF.

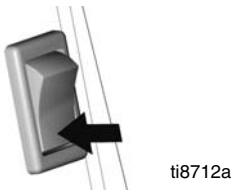

2. Trigger gun into material hopper.

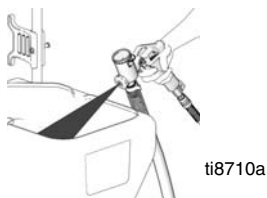

3. Open gun air valve.

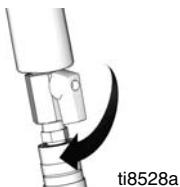

Grounding and Electrical Requirements

This sprayer must be grounded. Grounding reduces the risk of electrical shock by providing an escape wire for the electrical current. The sprayer cord includes a grounding wire with an appropriate grounding plug. The plug must be plugged into an outlet that is properly installed and grounded in accordance with all local codes and ordinances.

Check with a qualified electrician or serviceman if grounding instructions are not completely understood, or if in doubt as to whether the product is properly grounded. Do not modify plug provided; if it will not fit the outlet, have proper outlet installed by a qualified electrician.

				
<p>Air hose fittings can get hot! Allow sprayer to cool down 15 minutes before removing air hose.</p>				

120V AC Systems

- This equipment requires a 120V AC, 60 Hz, 15A circuit with a grounding receptacle. Do not use an adapter with this product.

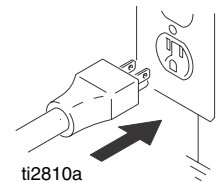

Extension Cords

- Use only an extension cord with an undamaged, 3-prong plug.
- For 25 to 50 ft (7.6 to 15.2 m) cords, use 3-wire, 14 AWG (1.5 mm²) minimum.
- For up to 100 ft. (30.48 m) cord, use 3-wire, 12 AWG (2.5 mm²) minimum.

Auxiliary Air Compressor

Do not use an auxiliary air compressor with this spray system.

Generator Requirements

3500 W (3.5 kW) minimum.

Hose Size and Length

The system comes with a hose set consisting of a 3/4 in. ID x 25 ft (25 mm x 7.6 m) material hose and a 3/8 in-ID air hose.

Do not use more than 25 ft (7.6 m) of material hose.

Setup



Texture Spraying (material supplied from unit)

NOTE: When using material supplied from unit, insert the Gun Plug in the top of the gun. Hose plug must be removed from bottom of gun.

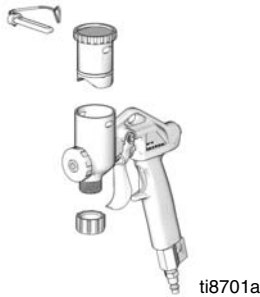

1. Connect air hose and material hose to sprayer air and material hose outlets.

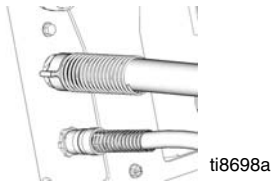

2. Connect air hose to gun.

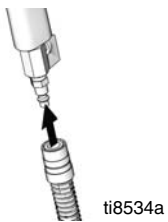

3. Open air valve.

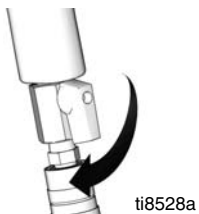

4. Connect material hose to gun.

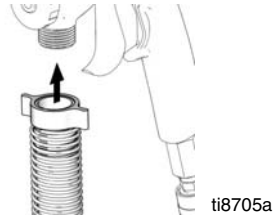

5. Install spray nozzle. See **Recommended Nozzle Selection Chart, Page 13.**

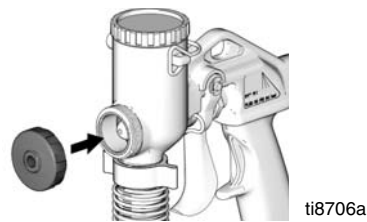

6. Fill material hopper with 1 gallon of water.

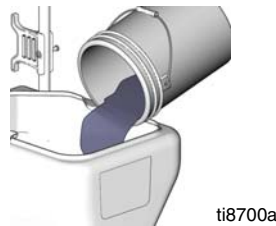

7. Turn selector knob to SPRAYER.

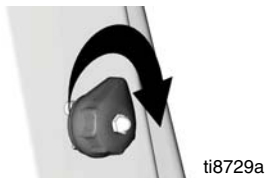

8. Turn power switch ON.

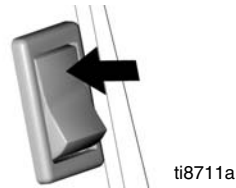

9. Close gun air valve.

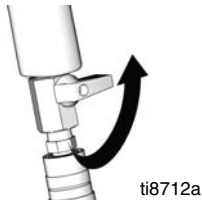

10. Point gun into waste bucket and pull trigger to pump water through the system. Continue to trigger gun until material hopper is empty.



11. Make sure burp guard is installed, **Caution**, page 3.

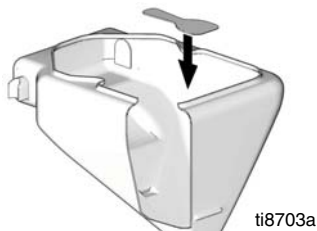

12. Add pre-mixed texture mix to material hopper. See **Mixing Material**, page 11.
13. Continue to trigger gun and spray into waste bucket until a steady stream of material sprays out of gun.
14. Release trigger. To achieve uniform spray pattern, adjust air valve and flow adjustment nut on gun. If you do not achieve the desired pattern, change nozzles, page 13.

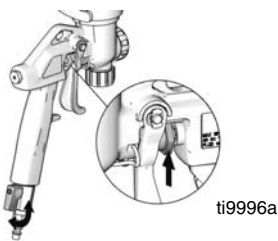

Touch Up Hopper Attachment

NOTE: The Hose Plug must be securely fastened to bottom of gun when using the Touch Up Hopper. Gun plug must be removed from top of gun.

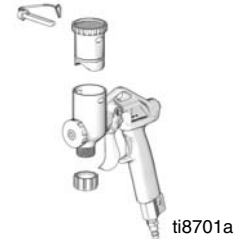

NOTICE

Failure to change selector switch to Hopper Gun when using hopper gun will damage pump hose.

1. Connect air hose to sprayer.
2. Connect air hose to gun.

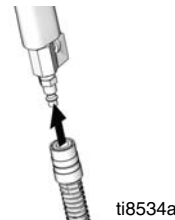

3. Slide hopper on top of gun, and tighten clamp.
4. Install spray nozzle, page 13.

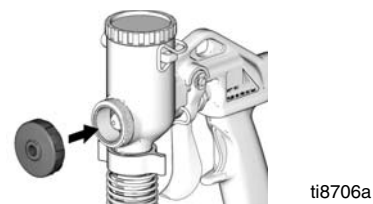

5. Fill Touch-up hopper with pre-mixed texture. See **Mixing Material**, page 11.

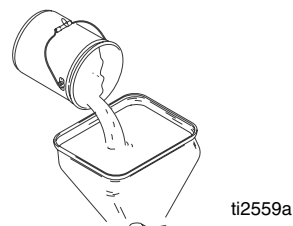

Setup

6. Turn selector knob to HOPPER GUN.

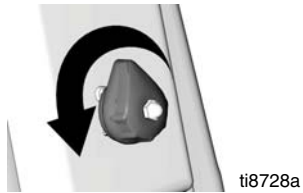

7. Open gun air valve.

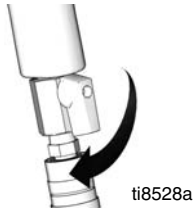

8. Turn power switch ON.

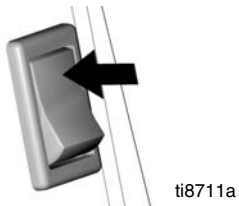

9. To achieve uniform spray pattern, adjust air valve and flow adjustment nut on gun. If you do not achieve the desired spray pattern, change nozzles (see page 13).

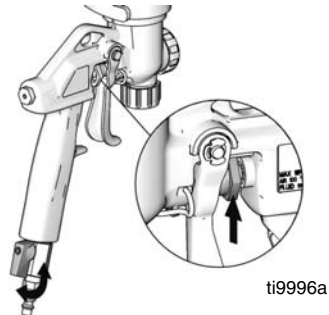

NOTE: Fluid flow will be restricted if the material hose is kinked.

NOTE: To increase pump life, turn power off when not spraying.

Mixing Material

NOTICE

Correct material mixture is essential. The pump will not operate if the mixture is too thick.

NOTE: Mix the material in a separate container before pouring it into hopper.

NOTE: Use Material Thickness Gauge to determine mixture is thin enough to spray.

*The Material Thickness Gauge will only determine if the material is thin enough to pass through the pump. For some applications or for higher speed spraying, your mixture may need to be thinner.

Dry Mix - 40 lb (18 kg) bag

NOTE: For best results do not use partial bags of material.

- Carefully mix texture material and water according to manufacturer instructions on bag.



- Agitate to mix, using a half-inch, variable speed drill with mixing paddle, to a smooth, lump-free consistency.

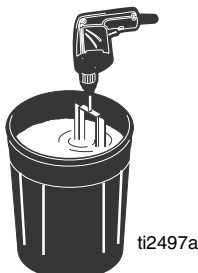

- Allow ceiling texture to set for at least 15 minutes. Then remix prior to use.
- After texture material is thoroughly mixed, gently set ball end of Material Thickness Gauge on surface of mixture.

NOTE: For an accurate test, be sure gauge is completely dry and clean every time it is used.

- Observe the ball on the material. When the material is thin enough to spray the ball will sink completely into the mixture.

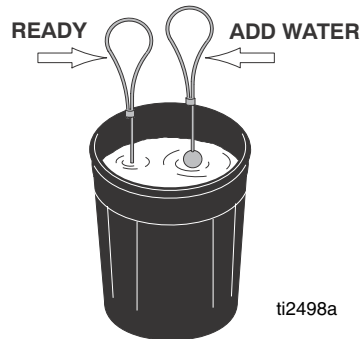

- If the ball does not sink completely into the mixture within 10 seconds, add more water, agitate and try test again.

Premix

1. Slowly add approximately 2 to 4 quarts (1.9 to 3.8 liters) of water to a 5 gallon (18.9 liter) bucket of pre-mix.



2. Agitate to mix, using a half-inch, variable speed drill with a mixing paddle, to a smooth, lump-free consistency.
3. After texture material is thoroughly mixed, gently set ball end of Material Thickness Gauge on surface of mixture.

4. Observe the ball in material. When the material is thin enough to spray the ball will sink completely into the mixture.

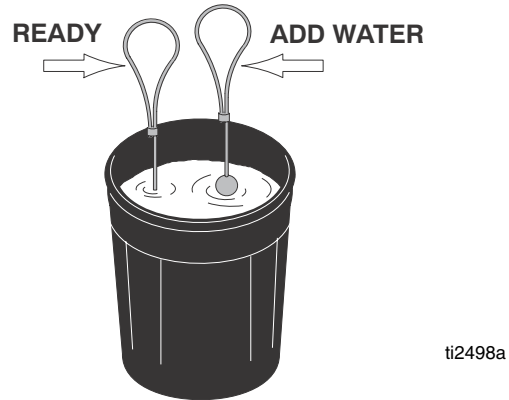

5. If the ball does not sink completely into the mixture within 10 seconds, add more water, agitate and try test again.

NOTE: For an accurate test, be sure gauge is completely dry and clean every time it is used.

Spray Techniques

Recommended Nozzle Selection Chart

Application	Nozzle Size ²	Air Volume ¹
Simulated Acoustic	6 mm, white (<i>fine to medium</i>) 8 mm, gray (<i>coarse</i>)	medium to high
Orange peel	4 mm, beige, 6 mm, white	medium to high
Splatter coat	6 mm, white 8 mm, gray	low to medium
Knockdown	8 mm, gray 12 mm, black	low

¹Control air volume with gun air valve.

²For more material volume try a larger nozzle.

Adjusting the System

Sufficient fluid output (volume and pressure) and good atomization is a balance of atomizing air, material thickness/material flow and nozzle selection. Achieving the correct balance for your application requires experimentation to achieve desired results. Keep in mind these important points when adjusting gun:

- Select proper nozzle for your application. See **Nozzle Selection Chart**. Remember, the larger the nozzle, the heavier the pattern.
- Start sprayer with gun air flow valve completely open. If needed, slowly close gun air flow until you get a good spray pattern. Use minimum amount of air at spray gun to achieve proper spray pattern and to minimize bounce back.

+ Test spray pattern on cardboard. Hold gun 18 to 24 in. (45.7 to 60.9 cm) from surface. Use this spraying distance for most applications.

- Air and material flow adjustments can be made at the gun.
 - + Opening air valve increases air flow through gun, which decreases texture material flow through pump.
 - + Closing air valve decreases air flow through gun, which increases texture material flow through pump.

To Get Less Material

Try one or a combination of these methods:

- Open air valve.
- Turn gun flow adjustment nut to decrease flow, counter-clockwise.
- Use smaller nozzle.

To Get More Material

Try any one or a combination of these methods:

- Close air valve.
- Turn gun flow adjustment nut to increase flow, clockwise.
- Use thinner material mixture.
- Use a larger nozzle.

Preventing Material Surge at Gun Trigger

Pressure will build up in the system when you stop triggering the gun. To prevent material surge at initial gun triggering:

- Point gun away from surface you are spraying when you first pull trigger.
- When you first start to spray, hold the gun away from the surface and gradually work your way closer to it.
- Keep gun moving.
- After you begin spraying, trigger the gun as little as possible.

For Continuous Spraying

Use trigger lock to hold trigger open and reduce fatigue.

Check Material Consistency Periodically

Check and thin material as needed to maintain proper consistency. The material may thicken as it sits and slow down production. Agitate periodically.

Shutdown and Cleanup

NOTICE

- Keep pump and hose clean when switching between simulated acoustic, knockdown and orange peel applications. A dirty pump can release particles of texture into the finish.
- To prevent damage, before removing material hose, be sure pressure is relieved and material is not in hose.
- To keep unit in good operating condition, always clean it thoroughly and prepare it properly for storage. Do not allow material to dry inside pump, hoses, gun or spray system to prevent damage to equipment.



Texture Spraying (8 Gallon Material Hopper)

When you have finished spraying:

1. Open gun air valve.



ti8528a

2. Make sure selector knob is turned to SPRAYER.



ti8729a

3. Turn power switch ON.



ti8711a

4. Close gun air valve.
5. Trigger gun into bucket until most of texture mix is pumped out.
6. Fill material hopper with 2-4 gallons of clean water.
7. Spray inside material hopper to circulate water through gun and hose. While circulating water, use gun to clean material hopper.



ti8710a

8. Partially open gun air valve to use air to achieve better cleaning results.
9. Spray water into a waste bucket to empty material hopper.

NOTE: A soft brush can be used to loosen dried on material.

10. Turn power switch OFF.
11. Open gun air valve. **Relieve Pressure**, page 7.

NOTICE

If water freezes in unit damage may occur. In cold weather store system where it will not freeze.

Removing Material Hopper From Sprayer

The material hopper can be removed for cleaning. To remove material hopper:

1. Loosen bottom fitting.

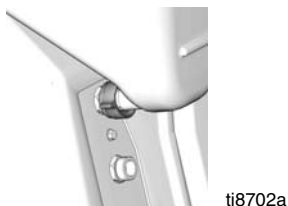

2. Lift and twist material hopper to remove from unit.

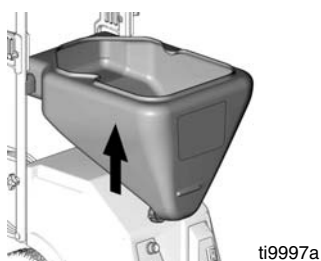

3. Plug opening on bottom of material hopper with your hand.
4. Take hopper to cleaning area.

To Reassemble:

1. Place material hopper on sprayer, aligning fitting to sprayer.
2. Hand tighten fitting.

Touch-up Hopper Attachment

When you have finished spraying

1. Shut off compressor. Disconnect air line from gun.
2. Drain material into a bucket until most of the texture material is out of hopper.



3. Fill hopper with clean water. Remove nozzle from gun and allow water to flow through and out of gun.
4. Flush until gun is clean

5. Turn power switch ON.

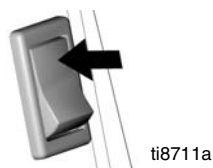

6. Open gun air valve.



7. Trigger gun to blow air through tip, clearing out any remaining material.
8. Remove hopper from gun and finish cleaning all components. A soft brush may be used to help loosen any dried on material from surface.

NOTE: Be sure to keep air passages in needle clean and free of material.

To improve working condition for future use, after cleaning, apply a few drops of light oil to:

- Air hose quick disconnect
- Material hose connections
- Flow adjustment on gun

Transporting the Sprayer

The handle and hopper can be removed from the sprayer for storage or transporting.

To remove hopper from sprayer, follow the procedure described on page 15.

To remove the handle:

1. Loosen two (2) wing-nut screws on either side of handle.
2. Spread handle apart and remove.

NOTE: The handle is only to be used to push or pull the sprayer.

Troubleshooting



Problem	Cause	Solution
Sprayer won't run	Power switch not on	Turn switch on.
	No power at wall outlet	Check outlet by plugging in another appliance. If appliance does not work, try another outlet.
	Wrong size generator	Use a 3500 watt or larger generator. Refer to Generator Requirements, page 7.
	Breaker tripped	Reset breaker
Pump won't pump material	Air lock	Open air valve on gun
	Selector switch in wrong position	Move selector switch to correct position for application
	Mix too thick	Add water to thin material. Use Material Thickness Gauge.
	Loose fittings	Check and retighten all fittings
	Plugged gun	Relieve Pressure, page 7. Remove gun from hose. Clean gun.
	Pump hose worn out	Replace hose. Recommended hose replacement - once every year.
	Pump cold	Move pump to warm room and allow it to warm up or run hot water through sprayer.
Material runs out of bottom of sprayer	Pump hose worn out	Replace hose
	Loose fittings	Check and retighten all fittings
No air from compressor	Gun air valve closed	Open gun air valve
	Low voltage	Check extension cord length and gauge. Replace if different than recommended. Refer to Grounding and Electrical Requirements, page 7.
	Gun needle plugged	Clean needle and retry.
	Worn compressor	Replace compressor. Contact an authorized Airlessco/Graco Service Center.
	Lines not connected	Check all quick disconnect connections to gun and hoses
	Damaged hose	Replace hose

Problem	Cause	Solution
Speed of application slow or slower	Material too thick	Thin material.
	Nozzle too small	Change nozzles to a larger size. See Recommended Nozzle Selection Chart, page 13.
	Too much air being used.	Partially close gun air valve to reduce air flow.
	Pump hose worn	Replace hose.
	Plugged or dirty gun	Relieve Pressure, page 7. Clean gun.
	Kinked hose	Unkink hose.
	Gun adjustment set too low	Increase flow adjustment with flow adjustment nut.
	Too many items on same circuit	Unplug other items from circuit
	Extension cord too long or wrong gauge	Use a different extension cord. Refer to Grounding and Electric Requirements, page 7.
Intermittent flow/sputtering	Hopper connection not tight	Check gasket. Tighten connection.
	Debris in system	Clean
Quick disconnect does not stay connected.	Dirty or corroded fitting	Clean thoroughly. Soak in oil. Apply a few drops of light oil.
Gun will not shut off	Worn nozzle or needle.	Relieve Pressure, page 7. Replace worn parts.
	Debris in needle passage	Relieve Pressure, page 7. Clean.
Fluid leaking at Flow Adjustment Nut	Damaged seal.	Relieve Pressure, page 7. Replace seal.
Fluid leaking out of either plug	Missing or damaged o-rings	Relieve Pressure, page 7. Replace o-rings.
	Gun damaged	Replace gun
Needle adjustment won't adjust	Dirty threads	Clean threads
	Nozzle not on gun	Put nozzle on gun

Technical Data

Main Unit Power Requirements	120 Vac, 60 Hz, 15A, 1 phase
Maximum Fluid Working Pressure	60 psi (.41 MPa, 4.1 bar)
Maximum Air Working Pressure	50 psi (.35 MPa, 3.5 bar)
Compressor Specifications	Universal motor thermally protected, oil-less
Compressor air displacement	4.0 scfm at 45 psi
Generator required	3500W minimum
Electric Motor	Universal AC 14 Amp 1.5 Hp
Power Cord	16 AWG, 3-wire, 25 ft
Material Hopper Capacity	Model 24F566: 8 gallons Gun material hopper: 3/4 gallon
Maximum Delivery with Texture	TS900 - 0.9 gpm (3.4 lpm)
Dimensions: TS900	
Length	23 in. (584 mm) with handle
Width	15.5 in. (393 mm)
Height (no handle)	40.5 in. (1028 mm)
Weight (includes hoses or gun)	60 lb (27.2 kg)
Wetted Parts	brass, aluminum, plastic
Sound Data (less compressor)	
Sound Pressure Level	83.2 dB(A)
Sound Power Level	97.5 dB(A)
Storage Temperature Range	35°F - 160°F (1.6°C - 71°C)
Operating Temperature Range	40°F - 115°F (4°C - 46°C)
Gun:	
Maximum Fluid Working Pressure	70 psi (.5 MPa, 5 bar)
Maximum Air Working Pressure	100 psi (.7 MPa, 7 bar)
CFM Rating	3.5 - 11 CFM
Weight	1.1 lb (500 g)

*Measured while spraying at 1 m.

**Measured per ISO-3744

Airlessco Standard Warranty

Airlessco warrants all equipment referenced in this document which is manufactured by Airlessco and bearing its name to be free from defects in material and workmanship on the date of sale to the original purchaser for use. With the exception of any special, extended, or limited warranty published by Airlessco, Airlessco will, for a period of twelve months from the date of sale, repair or replace any part of the equipment determined by Airlessco to be defective. This warranty applies only when the equipment is installed, operated and maintained in accordance with Airlessco's written recommendations.

This warranty does not cover, and Airlessco shall not be liable for general wear and tear, or any malfunction, damage or wear caused by faulty installation, misapplication, abrasion, corrosion, inadequate or improper maintenance, negligence, accident, tampering, or substitution of non-Airlessco component parts. Nor shall Airlessco be liable for malfunction, damage or wear caused by the incompatibility of Airlessco equipment with structures, accessories, equipment or materials not supplied by Airlessco, or the improper design, manufacture, installation, operation or maintenance of structures, accessories, equipment or materials not supplied by Airlessco.

This warranty is conditioned upon the prepaid return of the equipment claimed to be defective to an authorized Airlessco distributor for verification of the claimed defect. If the claimed defect is verified, Airlessco will repair or replace free of charge any defective parts. The equipment will be returned to the original purchaser transportation prepaid. If inspection of the equipment does not disclose any defect in material or workmanship, repairs will be made at a reasonable charge, which charges may include the costs of parts, labor, and transportation.

THIS WARRANTY IS EXCLUSIVE, AND IS IN LIEU OF ANY OTHER WARRANTIES, EXPRESS OR IMPLIED, INCLUDING BUT NOT LIMITED TO WARRANTY OF MERCHANTABILITY OR WARRANTY OF FITNESS FOR A PARTICULAR PURPOSE.

Airlessco's sole obligation and buyer's sole remedy for any breach of warranty shall be as set forth above. The buyer agrees that no other remedy (including, but not limited to, incidental or consequential damages for lost profits, lost sales, injury to person or property, or any other incidental or consequential loss) shall be available. Any action for breach of warranty must be brought within two (2) years of the date of sale.

AIRLESSCO MAKES NO WARRANTY, AND DISCLAIMS ALL IMPLIED WARRANTIES OF MERCHANTABILITY AND FITNESS FOR A PARTICULAR PURPOSE, IN CONNECTION WITH ACCESSORIES, EQUIPMENT, MATERIALS OR COMPONENTS SOLD BUT NOT MANUFACTURED BY Airlessco. These items sold, but not manufactured by Airlessco (such as electric motors, switches, hose, etc.), are subject to the warranty, if any, of their manufacturer. Airlessco will provide purchaser with reasonable assistance in making any claim for breach of these warranties.

In no event will Airlessco be liable for indirect, incidental, special or consequential damages resulting from Airlessco supplying equipment hereunder, or the furnishing, performance, or use of any products or other goods sold hereto, whether due to a breach of contract, breach of warranty, the negligence of Airlessco, or otherwise.

FOR AIRLESSCO CANADA CUSTOMERS

The Parties acknowledge that they have required that the present document, as well as all documents, notices and legal proceedings entered into, given or instituted pursuant hereto or relating directly or indirectly hereto, be drawn up in English. Les parties reconnaissent avoir convenu que la rédaction du présente document sera en Anglais, ainsi que tous documents, avis et procédures judiciaires exécutés, donnés ou intentés, à la suite de ou en rapport, directement ou indirectement, avec les procédures concernées.

TO PLACE AN ORDER OR FOR SERVICE, contact your Airlessco distributor,
or call 1-800-223-8213 to identify the nearest distributor.

*All written and visual data contained in this document reflects the latest product information available at the time of publication.
Airlessco reserves the right to make changes at any time without notice.*

For patent information, see www.graco.com/patents.

Original Instructions. This manual contains English. MM 3A1169

**Airlessco, 3501 N. 4th Avenue, Sioux Falls, SD 57104
Copyright 2010, Airlessco Inc is registered to ISO 9001.**

**www.airlessco.com
Revised September 2012**