

Airlessco Direct-Drive Pressure Washer 3A0819B

EN

*-For high pressure water cleaning-
-For outdoor use only-*



IMPORTANT SAFETY INSTRUCTIONS

Read all warnings and instructions in this manual.
SAVE THESE INSTRUCTIONS.

Model	Horse Power and Motor Brand	Maximum Working Pressure		
		PSI	MPa	bar
2525	160cc Honda	2500	17.24	172.4
2730	200cc Honda	2700	18.62	186.2
3030	270cc Honda	3000	20.68	206.8

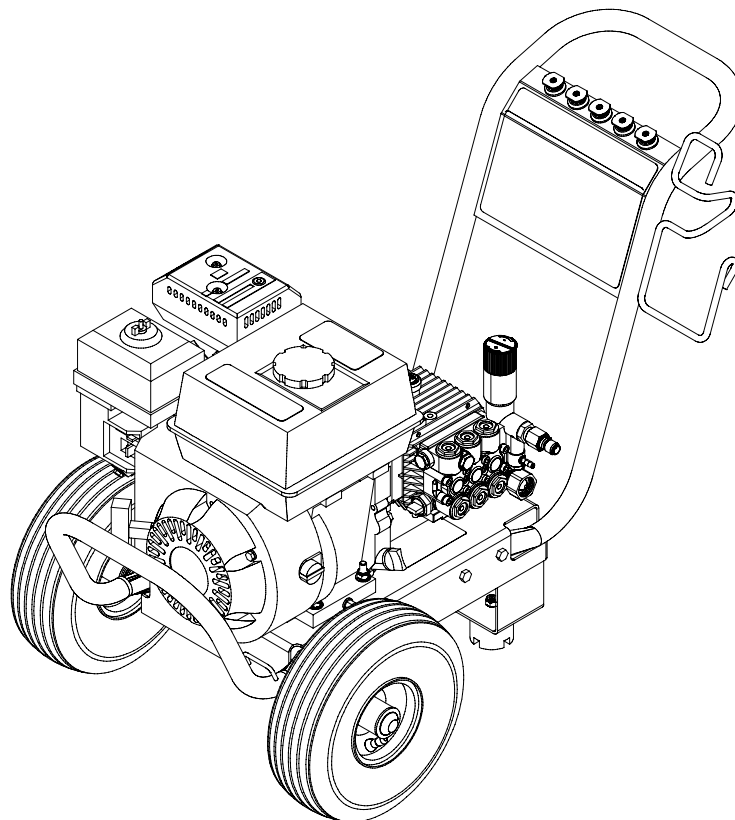

PROVEN QUALITY. LEADING TECHNOLOGY.

CONTENTS

Important	3	Pump Service: 2525 Model Pressure Washers	17
Spray Precautions	3	For Outlet Valves	17
Fire & Ventilation Precautions	4	For Inlet Valves	17
Carbon Monoxide Hazard	4	Servicing Plungers Or Internal Bearings	17
Detergent Cleaning Precautions	4	Servicing V-packings.....	17
Burn Hazard	4	Pump Service: 2730 Model Pressure Washers	18
Miscellaneous Safety Precautions	5	Valves	18
Adjustment Precautions	5	Pumping Section	18
Personal Protective Equipment	5	Servicing Plungers.....	18
Component Identification	6	Servicing V-packings.....	18
Installation & Preparation instructions	7	Pump Service: 3030 Model Pressure Washers	19
Attire	7	Valves	19
Setup	7	Pumping Section	19
Engine Fuel Tank	8	Servicing Plungers.....	19
Nozzle Review	8	Servicing V-packings.....	19
Nozzle Connection	9	Pressure Washer - Parts 262305- Model 2525DD	20
Water Supply	9	Pump Assembly - Parts - Series A 24E735 (For Use	
Unloader	10	With Model 2525DD)	22
Thermal Relief Valve	10	Pump Assembly - Parts - Series B 24R713 (For Use	
Pre-start Inspection Procedures	10	With Model 2525DD)	24
Operating Instructions	11	Pressure Washer - Parts 262306- Model 2730DD	26
Priming The Pump.....	11	Pump Assembly - Parts 244749 (For Use With Model	
Start-up	12	2730DD).....	28
Cleaning With Detergents.....	13	Pressure Washer - Parts	
Shutdown	13	262308- Model 3030DD	30
Storage & Maintenance Instructions	14	Pump Assembly - Parts	
Engine.....	14	24E753 (For Use With Model 3030DD)	32
Pump	14	Notes	34
Nozzles.....	14	Technical Data	35
Quick Couplers.....	14	Airlessco Standard Warranty	36
Winterizing.....	15		
Troubleshooting	16		

THIS SPARK IGNITION SYSTEM COMPLIES WITH
CANADIAN ICES-002.
CE SYSTÈME D'ALLUMAGE PAR ÉTINCELLE EST
CONFORME À LA NORME NMB-002 DU CANADA.

The following warnings are for the setup, use, grounding, maintenance, and repair of this equipment. The exclamation point symbol alerts you to a general warning and the hazard symbols refer to procedure-specific risks. When these symbols appear in the body of this manual, refer back to these Warnings. Product-specific hazard symbols and warnings not covered in this section may appear throughout the body of this manual where applicable.

⚠ WARNING	
	<p>IMPORTANT USER INFORMATION</p> <p>The engine exhaust from this product contains chemicals known to the State of California to cause cancer, birth defects or other reproductive harm.</p> <p>This product contains one or more chemicals known to the State of California to cause cancer and birth defects or other reproductive harm.</p> <p>The following is required by California State law, Section 4442 of the California Public Resources Code. Other states may have similar laws. Federal laws apply on federal lands.</p> <ul style="list-style-type: none"> • A spark arrester must be added to the muffler of this engine if it is to be used on any forest covered, brush covered or grass covered unimproved land. The arrester must be maintained in effective working order by the operator. • See your engine or equipment dealer for spark arrester muffler options.
	<p>SPRAY PRECAUTIONS</p> <p>Risk of injection or severe cutting injury. If an accident does occur and the spray appears to have penetrated the skin, seek emergency medical care. Do not treat as a simple cut. If you are using cleaning agents, be prepared to tell a physician exactly what kind.</p> <ul style="list-style-type: none"> • Keep clear of nozzle. • Do not direct discharge stream at persons or pets. • Only trained operators should use this product. When operating this unit, basic precautions should always be observed. • Keep away from the spray. Because of the high pressure and velocity of the spray, fluids can penetrate the skin, causing serious injury. • Never point the gun at yourself or anyone else. Never put your hand, fingers or body directly over the spray nozzle. Always keep operating area clear of all persons. Use extreme caution when operating near children. <p>Always wear protective goggles when operating the unit to shield the eyes from flying debris and detergents. Other protective equipment such as rubber suits, gloves and respirators are advisable, especially when using cleaning detergents. Use extreme caution when operating near children.</p> <ul style="list-style-type: none"> • Stay alert-watch what you are doing. Do not operate the unit when fatigued or under the influence of alcohol or drugs. • Never squeeze the trigger unless securely braced. The thrust from the water traveling through the nozzle may be powerful enough to cause the operator to lose balance if unprepared. Do not overreach or stand on unstable support. Wet surfaces can be slippery, wear protective foot gear and keep good footing and balance at all times. Never trigger the gun while on a ladder or roof. • Caution should be used when directing spray toward fragile materials such as glass. Shattering could result in serious injury. • Always hold on firmly to the gun/wand assembly when starting and operating the unit. Failure to do so can cause the wand to fall and whip dangerously. Never operate the gun with the trigger wired in the open position. To prevent accidental discharge, the trigger gun should be securely locked when not in use.

⚠ WARNING

- Do not direct spray on or into electrical installations of any kind! This includes electrical outlets, light bulbs, fuse boxes, transformers, etc. Severe electrical shock may occur.
- Even after you shut off the unit, there is high pressure water left in the pump, hose and gun until you release it by triggering the gun. Before removing the spray nozzle or servicing the unit, always shut off the unit and trigger the gun to release trapped pressure.

FIRE & VENTILATION PRECAUTIONS



- This unit was designed for outdoor use only. Never operate this unit in an enclosed area. Always make certain there is adequate air (oxygen) for combustion as well as ventilation to prevent the presence of poisonous carbon monoxide gases. Beware of poorly ventilated areas or exhaust fans which can cause inadequate combustion or engine overheating.
- Never operate this unit in the presence of flammable vapors or combustible dust, gases or other combustible materials. (A spark may cause an explosion or fire.) When servicing this machine, be especially careful to properly dispose of any flammable materials. Do not spray flammable liquids.
- Do not smoke while filling engine fuel tank
- Never fill the engine fuel tank while the unit is running or hot. Allow the engine to cool two minutes before refueling.
- Do not refuel indoors or in a poorly ventilated area.
- Always refuel slowly to avoid the possibility of spilled fuel which may cause a risk of fire.
- Do not operate the unit if gasoline is spilled. Wipe unit clean and move the unit away from the spill. Avoid creating any ignition until the gasoline has evaporated.
- Do not store the unit near an open flame or any equipment such as a stove, furnace, water heater, etc., which utilizes a pilot light or devices which can create a spark.

CARBON MONOXIDE HAZARD



- Exhaust contains poisonous carbon monoxide, which is colorless and odorless. Breathing carbon monoxide can cause death.
- Do not operate in an enclosed area.

DETERGENT CLEANING PRECAUTIONS



- Do not use solvents or highly corrosive detergents or acid type cleaners with this pressure washer.
- Know your detergent. Be prepared to tell a physician exactly what you are using in the event of an emergency. Read the Material Safety Data Sheet (MSDS) provided with your detergent and all detergent labels. Follow all appropriate instructions regarding preparation use, safety and transportation. Keep all detergents out of the reach of children.
- Do not use this pressure washer to dispense hazardous detergents.
- Do not alter the detergent injection feature in any manner not prescribed in this manual. Use only genuine replacement parts for necessary repairs.

BURN HAZARD



- Equipment surfaces and fluid that's heated can become very hot during operation. To avoid severe burns:
- Do not touch hot fluid or equipment.

⚠ WARNING

MISCELLANEOUS SAFETY PRECAUTIONS



Never allow children or adolescents to operate this unit.



Read and follow all handling, operations, maintenance and safety instructions listed in this manual and the engine operator's manual that accompanies this unit, and provide such information to anyone who will be operating this unit.

In freezing temperatures, the unit must always be warm enough to ensure there is no ice formation in the pump. Do not start this unit if it has been transported in an open or under heated vehicle without first allowing the pump to thaw.

When connecting the water inlet to the water supply mains, local regulations of your water company must be observed. In some areas the unit must not be connected directly to the public drinking water supply. This is to ensure that there is no feedback of the detergents into the water supply. (Direct connection is permitted if a back flow preventer is installed.)

Do not allow any part of your body or the high pressure hose to make contact with the muffler. Avoid dragging the hose over an abrasive surface such as cement. This causes wear and eventual rupturing.

High pressure hoses should be inspected daily for signs of wear. If evidence of failure exists, promptly replace all suspect hoses to prevent the possibility of injury from the high pressure spray. If a hose or fitting is leaking, never place your hand directly on the leak.

Do not operate the unit without all protective covers in place.

Never run the unit with the governor disconnected or operate at excessive speeds.

To reduce the risk of injury, maintain a safe distance for persons while operating this unit. Close supervision is necessary when operating the unit near children.

Do not leave pressurized unit unattended. Shut off the unit and release trapped pressure before leaving.

Do not move the unit by pulling on the hose.

ADJUSTMENT PRECAUTIONS



- Never alter or modify the equipment, be sure any accessory items and system components being used will withstand the pressure developed. Use only genuine parts for repair of your pressure washer. Failure to do so can cause hazardous operating conditions and will void warranty.
- Never make adjustments to the machinery while it is connected to the engine without first removing the ignition cable from spark plug. Turning the machinery over by hand during adjustment or cleaning might start the engine and machinery with it, causing serious injury to the operator.
- Know how to stop the pressure washer and bleed pressures quickly. Be thoroughly familiar with controls.
- Before servicing the unit; turn the unit off, relieve the water pressure, and allow the unit to cool down. Do not make repairs while unit is running. Service in a clean, dry, flat area. Block the wheels to prevent the unit from moving.
- Follow the maintenance instructions specified in this manual.

PERSONAL PROTECTIVE EQUIPMENT



You must wear appropriate protective equipment when operating, servicing, or when in the operating area of the equipment to help protect you from serious injury, including eye injury, hearing loss, inhalation of toxic fumes, and burns. This equipment includes but is not limited to:

- Protective eyewear, and hearing protection.
- Respirators, protective clothing, and gloves as recommended by the detergent manufacturer.

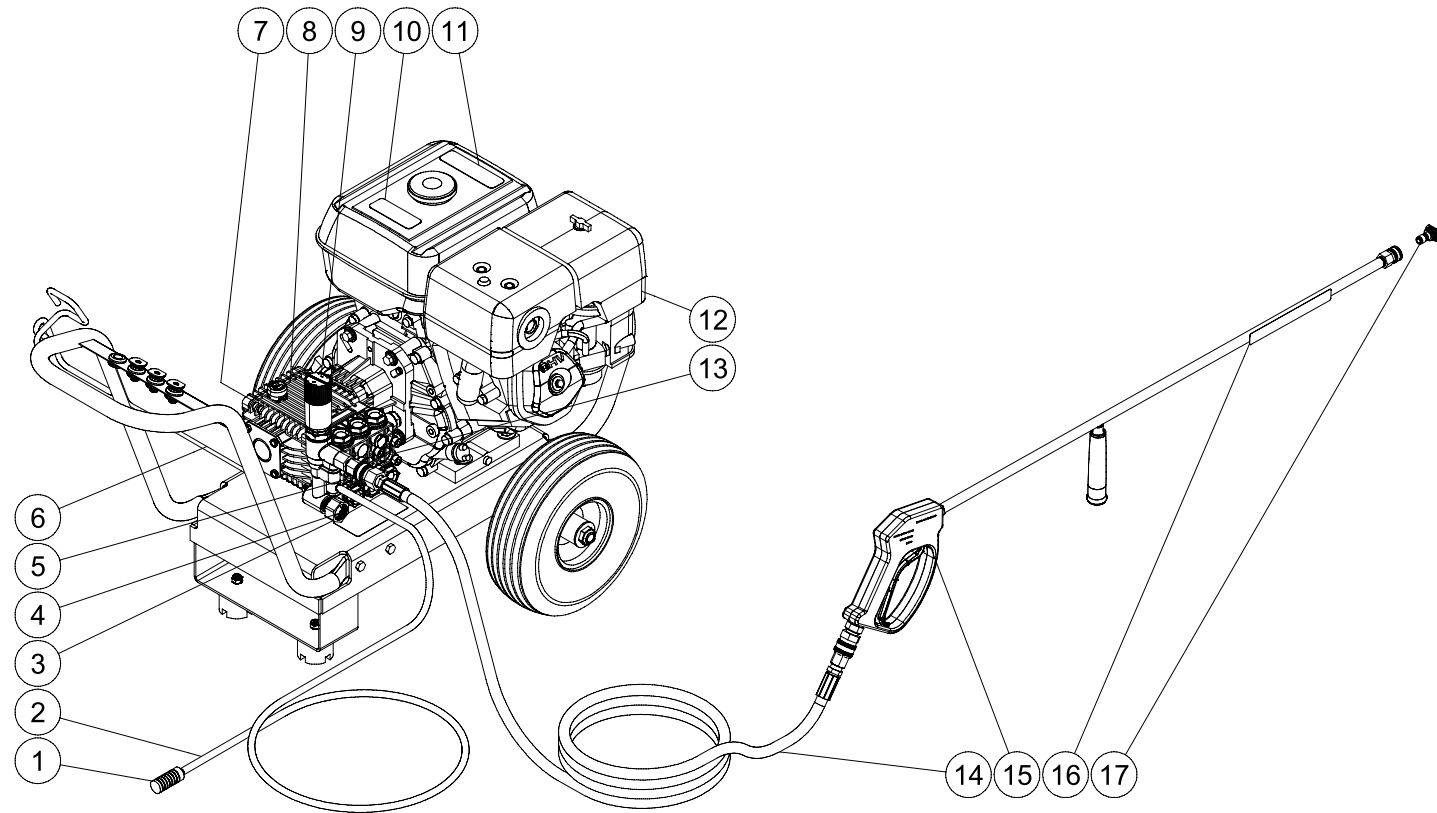

Component Identification



Item	Description
1.	Detergent Strainer
2.	Detergent Hose
3.	Water Inlet
4.	Water Inlet Strainer
5.	Water Outlet
6.	Decal - Warning/Caution/Operation
7.	Oil Sight Glass
8.	Pump
9.	Adjustable Unloader Knob
10.	Decal - Caution: Risk Of Fire
11.	Decal - Warning: Risk Of Burns
12.	Engine
13.	Thermal Relief Valve
14.	High Pressure Discharge Hose
15.	Gun Assembly
16.	Decal - Warning: Risk Of Injection
17.	Quick Connect Nozzle



INSTALLATION & PREPARATION INSTRUCTIONS

Attire



 Proper attire is essential to your safety. It is advised to utilize whatever means necessary to protect eyes, ears, and skin. Additional safety attire (such as respiratory mask) may be required when using detergent cleaning agents with this washer.

Setup

This unit should only be placed on a level surface to ensure proper lubrication for the engine and water pump while operating.



 Do not use unit in an area:

- with insufficient ventilation.
- where there is evidence of oil or gas leaks.
- where flammable gas vapors may be present.

Be certain to block the wheels to prevent the unit from moving while operating.



 Do not allow the unit to be exposed to rain, snow or freezing temperatures. If any part of the unit becomes frozen, excessive pressure may build up in the unit which could cause it to burst resulting in possible serious injury to the operator or bystanders.

Before initial use, ensure the oil cap/dipstick is inserted into the pump. Because of varying shipping requirements, the pump may need to be shipped with an oil travel plug instead of the dipstick in the pump. If your pump has been shipped with an oil travel plug, you will need to remove it and replace the plug with the oil dipstick provided with the unit.

Once properly installed, check the oil sight glass on the pump crankcase. Be certain the oil level is in the center of the sight glass before each use. If the level appears to be low, add pump oil and fill only to the center of the oil sight glass. (Refer to the parts listing for the correct pump oil) do not overfill!

INSTALLATION & PREPARATION INSTRUCTIONS

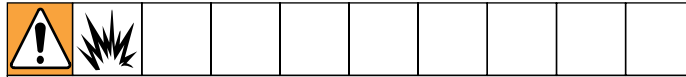
Engine Fuel Tank



Review "Fire & Ventilation Precautions" pg. 4, before fueling.

Locate the Safety Decals on your unit and heed their warnings.

A minimum of 86 octane fuel is recommended for use with this unit. Do not mix oil with gasoline.

Purchase fuel in quantities that may be used within 30 days. Use of clean, fresh lead free gasoline is recommended. Leaded gasoline may be used if lead-free is unavailable. Do not use gasoline containing methanol or alcohol.

Check the engine oil level before starting the engine. (See engine manual.)

Fill the fuel tank according to accompanying engine manual instructions.

Occasional carburetor and choke adjustments will be necessary for the engine. Refer to the engine manual supplied with this unit for proper adjustment procedures.

Review the engine manual accompanying this pressure washer for correct engine start-up and maintenance procedures.

Nozzle Review

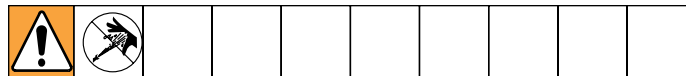

Various nozzles may be quick-connected into the end of the wand to change the spray pattern or use the detergent feature. When using Quick Connects (Q.C.), be certain the connection is securely locked. If not, the high pressure water may shoot the nozzle from the wand, causing severe injury or serious damage.

To determine spray fan, refer to the actual number stamped on the nozzle. The first two digits indicate the spray fan in degrees, i.e.; 0=0°, 15=15°, 25=25°, 40 = 40°, 65=detergent/low pressure.

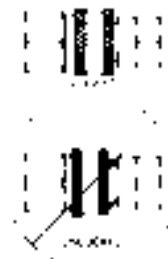

The 0° nozzle (RED): This is a blasting nozzle. It delivers a very concentrated stream of water. Be cautious when using the straight narrow stream. It is not recommended for use on painted or wood surfaces, or items attached with adhesive backings. Uses: Removing weeds from sidewalk cracks, stubborn stains from concrete, masonry, aluminum and steel, caked mud from equipment, and cleaning lawn mower undersides.

The 15° nozzle (YELLOW): This is a chiseling nozzle. The spray should be directed at a 45° angle to the surface and used like a scraper to remove paint, grease and dirt. Uses: Surface preparation (removing mildew stains and paint chips).

The 25° nozzle (GREEN): This is a flushing nozzle. This pattern is best suited for flushing dirt, mud, and grime. Uses: Wet sweeping leaves from walks, curbs and driveways, cleaning stable floors, washing swimming pool bottoms, degreasing engines.

The 40° nozzle (WHITE): This is a wash nozzle. This wide spray pattern disperses the water pressure over a large area and is recommended for moderate washing. Uses: Washing down aluminum siding, cleaning windows, washing vehicles, spraying sidewalks, driveways and patios. (not available for Model 2525)

The 65° nozzle (BLACK): This is a low pressure detergent application nozzle. This broad spray pattern distributes solution over vast areas under low pressure. Uses: Detergent application, misting or rinsing.

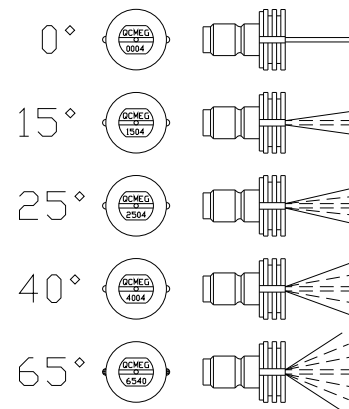

INSTALLATION & PREPARATION INSTRUCTIONS



Nozzle Connection

Be certain the trigger gun is locked in the "OFF" position.

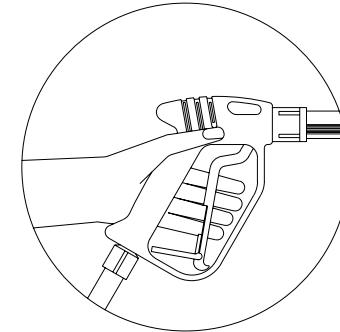

The nozzle assembly should be disconnected from the gun/wand assembly at this time by retracting the locking ring on the quick-connect fitting to remove the nozzle.

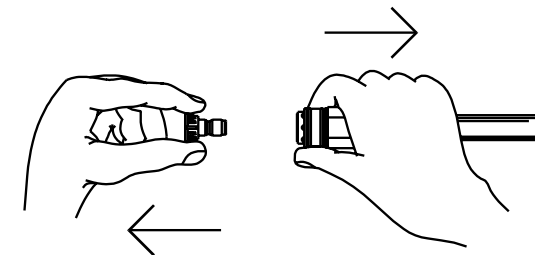

Water Supply

Select a water supply hose which is a quality grade of garden hose measuring at least 3/4" ID and no longer than 50 feet.

Check the water inlet strainer to ensure it is clean and free of any obstructions. Periodic cleaning of the water strainer will help prevent pump problems.

NOTICE

As a strainer becomes obstructed, it restricts proper flow of water to the pump. This can result in cavitations which will cause premature failure of pump packings.

1. Using a screw driver, remove the screen from the water inlet.
2. Clean or replace if necessary.

Connect the hoses.

1. Connect one end of the water supply hose to the water inlet of the unit.
2. Connect the other end of the hose to your pressurized water supply.

Note: Do not use a non-pressurized water supply (i.e. from a pond or well) with this unit.

3. Connect the high pressure discharge hose to the water outlet of the unit.
4. Securely connect the other end of the hose to the gun assembly. (A wrench may be required on some models.)
5. Connect the wand assembly to the gun/hose assembly.

Follow the incoming water requirements listed below:

1. Water pressure must be a minimum of 25 pounds per square inch (PSI) and a maximum of 125 PSI. (A typical outdoor faucet will generally supply this PSI if turned completely "ON".)
2. Incoming GPM must be approximately one gallon more than the outgoing GPM stated on the pressure washer nameplate. (You can check GPM by timing how long it takes to fill a 5 gallon container.)

NOTICE

Incoming water temperature must not exceed 125°F for Model 2525, and 145°F for other models. Excessive pump damage may result if the water temperature exceeds this acceptable level.

NOTICE

Damage to the equipment could occur. Never allow the unit to operate without the incoming water line attached and the water supply completely turned on.

INSTALLATION & PREPARATION INSTRUCTIONS

Unloader

The unloader will either be adjustable or factory preset depending on the model you purchased.

Adjustable

The unloader valve on your machine is equipped with an adjustment knob to adjust the pressure. Should less pressure be required, simply turn the adjustment knob counterclockwise. To set back to maximum, turn adjustment knob completely clockwise. Do not overtighten.



Factory Preset (2525 DD Only)

The unloader valve on your machine is factory preset and should only be adjusted by a trained representative. Do not adjust the pressure on your own.



NOTICE

Do not overtighten the unloader. Breakage could result in immediate loss of water pressure and costly repairs.

Thermal Relief Valve

To ensure the water temperature does not exceed acceptable levels, never allow the pressure washer to operate in the bypass mode (with the unit running and the trigger gun closed) for more than three minutes.

A “thermal relief valve” has been added to this unit to protect the pump. It may begin to open and release water if the water temperature in the pump has exceeded 140°F. This will allow fresh, cool water to enter the system.

Pre-Start Inspection Procedures

Before starting the unit, perform the following procedures:

1. Check the oil level in the pump and engine.
2. Inspect the water inlet strainer. Clean or replace if necessary. See “Water Supply” pg. 9.
3. Check all hose connections to ensure they are securely tightened. See “Water Supply” pg. 9.

<p>Inspect for system fuel leaks. If a fuel leak is found, do not start unit. See “Fire & Ventilation Precautions” pg. 4. Be sure that all damaged parts are replaced and that the mechanical problems are corrected prior to operation of the unit. If you require service, contact Airlessco Customer Service.</p>										

<p>Inspect high pressure hoses for kinking, cuts and leaks. If a cut or leak is found, do not use hose. Replace hose before starting unit. See “Miscellaneous Safety Precautions” pg. 5. Be sure that all damaged parts are replaced and that the mechanical problems are corrected prior to operation of the unit. If you require service, contact Airlessco Customer Service.</p>										

OPERATING INSTRUCTIONS

Priming the Pump

It is essential to prime the pump on initial start-up and each time the water supply is disconnected from the unit after initial use.

1. Lay the high pressure hose out to remove any loops. Water flow will constrict the hose, creating tight loops if the hose is not straight.

Note: The nozzle assembly should not be connected to the gun assembly at this time. See “Nozzle Connection” pg. 9.



2. With the trigger gun locked in the “OFF” position, turn the water supply completely on. Pointing the gun in a safe direction, unlock the trigger gun and squeeze the trigger. Low pressure water will begin flowing from the hose/gun assembly. This allows the unit to prime and purge any air from the system. The unit is primed when water flow is uninterrupted by air.
3. Once the unit is primed, release the trigger and lock the gun in the “OFF” position. Securely connect the nozzle assembly. (See “Nozzle Connection” pg. 9)

NOTICE

Be certain the nozzle is not connected to the unit while priming the pump. Priming allows mineral deposits to be released from the system which would obstruct or damage the nozzle assembly resulting in costly repairs.

OPERATING INSTRUCTIONS

Start-Up



										
--	---	--	--	--	--	--	--	--	--	--

Refer to the "Safety Precautions" pgs. 3-5 before starting the unit.



Locate the Safety Decals on your unit and heed their warnings.

Never look directly into the nozzle. High pressure water creates a risk of severe injury.

1. With the gun locked in the "OFF" position, point the trigger gun away from yourself or anyone else. Ensure the water supply is completely turned on.
2. Disengage the safety lock-off on the gun and squeeze the trigger. Low pressure water will begin flowing from the nozzle.
3. Be certain the trigger gun remains in an open position while starting the engine. Brace yourself as the gun will kickback from the high pressure created by the pump once the engine has started.
4. Steady the unit during engine start-up. (Refer to the engine manual accompanying this pressure washer for the correct procedures needed to start the engine.)
5. Once the engine has started, perform the following procedures with the gun open:

										
--	---	--	--	--	--	--	--	--	--	--

Inspect for system oil leaks and fuel leaks. If a fuel leak is found, turn unit off immediately. See "Fire & Ventilation Precautions" pg. 4. Be sure that all damaged parts are replaced and that the mechanical problems are corrected prior to operation of the unit. If you require service, contact Airlessco Customer Service.

										
--	--	--	--	--	--	--	--	--	--	--

Inspect high pressure hoses for kinking, cuts and leaks. If a cut or leak is found, do not touch hose at leak. Turn unit off immediately. Replace hose before restarting the unit. See "Miscellaneous Safety Precautions" pg. 5. Be sure that all damaged parts are replaced and that the mechanical problems are corrected prior to operation of the unit. If you require service, contact Airlessco Customer Service.

6. Trigger the gun several times. Be certain to lock the trigger gun in the "OFF" position whenever changing the quick connect nozzles.

NOTICE										
---------------	--	--	--	--	--	--	--	--	--	--

Do not allow unit to operate in bypass mode (with trigger closed) for more than three minutes without triggering the gun. Failure to follow this simple rule can cause premature failure of pump packing seals, resulting in costly pump repair.



Because your pressure washer delivers a high pressure spray and a variety of spray patterns, there are many cleaning jobs that can be done without the use of detergents. If a cleaning agent is required, see "Cleaning With Detergents" pg. 13 for the correct procedures.

NOTICE										
---------------	--	--	--	--	--	--	--	--	--	--

Do not allow spray pattern to remain on a fixed area for an extended period of time. Possible damage may occur to the area.

OPERATING INSTRUCTIONS

Cleaning with Detergents

										
---	---	---	--	--	--	--	--	--	--	--

Refer to "Detergent Cleaning Precautions" pg. 4 before working with detergents. Be certain to wear protective safety attire.

Prepare detergent solution according to label directions. Never pump acids, alkaline, abrasive fluids or solvents through the unit.

Some units are equipped with adjustable detergent knobs. Locate the clear vinyl hose which leads to the pump head.

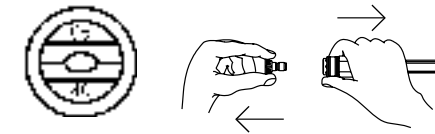

- If your injector is equipped with an adjustment knob on the pump head, you may adjust the amount of detergent desired by turning the knob completely counterclockwise to set at the maximum siphon rate.
 - If your injector is not equipped with an adjustment knob, the detergent ratio is preset and cannot be adjusted.
1. Immerse the detergent strainer into the detergent solution to allow detergent to siphon.
 2. With the trigger gun locked in the "OFF" position, secure quick-connect the detergent spray nozzle (#6540° BLACK) into the end of the wand.



Note: This injection system is designed to apply detergents under low pressure only. It will not allow detergent solutions to be introduced into the system unless the nozzle assembly is in the low pressure detergent mode.

3. To apply solution; unlock the trigger gun and squeeze the trigger. In a few moments a detergent/water mixture will exit the low pressure nozzle. Start spraying the lower portion of the surface being cleaned and move up, using long overlapping strokes. Applying from the bottom up helps avoid streaking. Allow to soak briefly. Do not allow detergent solution to dry on the surface. (Avoid working on hot surfaces or in direct sunlight to minimize the chances of the detergent drying, which may result in damaging painted surfaces.) Be certain to rinse a small section at a time.
4. To rinse; lock the trigger gun in the "OFF" position, securely quick-connect the desired high pressure nozzle into the end of the wand. Unlock the trigger gun and spray. It will take about 30 seconds to purge all detergent from the line. For best rinsing results, start at the top and work down.
5. Siphon a gallon of water through the low pressure detergent injection system after each use. This prevents the possibility of corrosion or detergent residue causing mechanical problems during the next use.

Shutdown

1. Turn engine "OFF" as directed in the engine manual.
 2. Turn the water supply "OFF".
- | | | | | | | | | | | |
|---|---|---|--|--|--|--|--|--|--|--|
|  |  |  | | | | | | | | |
|---|---|---|--|--|--|--|--|--|--|--|
3. Pointing the gun in a safe direction, trigger gun momentarily to relieve any trapped pressure.
 4. Once pressure is relieved, disconnect the nozzle assembly.
 5. Disconnect and drain gun, wand and hoses.
 6. Wipe unit clean and store with gun, wand and hoses in a safe, non-freezing area.

STORAGE & MAINTENANCE INSTRUCTIONS

Engine

The engine instructions that accompany your unit detail specific procedures for maintenance of the engine. Following the engine manufacturer's recommendations will extend engine work life.

Pump

The pump oil must be changed after the first 25 hours of operation on all units. Once the initial oil change has been completed, it is recommended the oil be changed every 3 months or 250 hour intervals. If oil appears dirty or milky, changes may be required at a greater frequency. Add pump oil and fill only to the center of the sight glass (Refer to the parts listing for the correct pump oil). Do not overfill.

Nozzles

Water flow through the spray nozzle will erode the orifice, making it larger, resulting in a pressure loss. Nozzles should be replaced whenever pressure is less than 85% of the maximum. The frequency of replacement will depend upon such variables as mineral content in the water and number of hours the nozzle is used.

Quick Couplers

There is an o-ring seal inside the female quick coupler. This o-ring will deteriorate or, if the unit is allowed to pump without the high pressure hose or nozzle attached, the o-ring may be blown out occasionally. Simply insert a replacement o-ring to correct the leak. (Additional o-rings can be purchased from your dealer.)

STORAGE & MAINTENANCE INSTRUCTIONS

Winterizing

For storage and transportation purposes in subfreezing ambient temperatures, it will be necessary to winterize this unit. This unit must be protected to the lowest incurred temperature for the following reasons:



- If any part of the pumping system becomes frozen; excessive pressure may build up in the unit which could cause the unit to burst resulting in possible serious injury to the operator or bystanders.
- The pumping system in this unit may be permanently damaged if frozen. Freeze damage is not covered by warranty.

If you must store your unit in an area where the temperature may fall below 32°F, you can protect your unit by following the procedure outlined below.

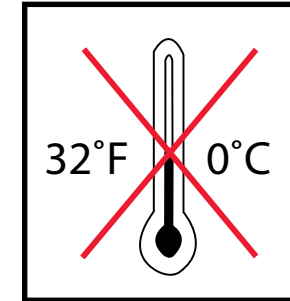

NOTICE

Do not store/operate unit in a freezing environment. Damage to washer could occur.

Gather the following items:

- Two 5 gallon containers.
- One gallon of antifreeze. (Airlessco® recommends an environmentally safe antifreeze.)
- Water supply.
- Three foot hose, 1/2-3/4 I.D. with a 3/4 inch male garden hose fitting.

Procedure:

1. To start winterizing, unit must be run and primed according to the "Start-up Procedures" listed on page 12.
2. After running and priming, shut off the unit and water supply.

3. Relieve system pressure by pointing the trigger gun in a safe direction and squeezing the trigger until water flow ceases to exit the nozzle.
4. Lock the trigger gun in an OFF position and remove the nozzle.
5. In one 5 gallon container, mix the antifreeze and water according to manufacturer's recommendations for the temperature to which you are winterizing.

Note: Proper winterizing is based on the recommended manufacturer's instructions listed on the "Protection Chart" shown on the back label of most antifreeze containers.

6. Remove the water supply hose from the unit and attach the 3 foot hose securely to the inlet connection. Submerge the other end into the antifreeze solution.
7. Shut off the detergent injector if applicable.
8. Point the wand into the empty container and start the unit.
9. Trigger the gun until the antifreeze begins to exit the wand. Release the trigger for 3 seconds, then trigger the gun for 3 seconds. Continue cycling the gun several times until all the antifreeze mixture is siphoned from the container.
10. Stop the unit.
11. Detach the 3 foot hose from the unit and drain any excess antifreeze back into the 5 gallon container.
12. Disconnect the hose/gun/wand assembly from the unit and drain any excess antifreeze back into the 5 gallon container.
13. Store the hose, gun and wand with the unit in a safe, non-freezing area.
14. Store antifreeze solution for next use or dispose of according to state EPA laws.

Optional Procedure:

1. Shut the unit and water supply off.
2. Relieve system pressure by pointing the trigger gun in a safe direction and squeezing the trigger until water flow ceases to exit the nozzle.
3. Disconnect and drain the hose, gun and wand.
4. Start the unit and allow it to run until all the water exits the unit. Once the water has stopped flowing from the unit, turn the unit off.

NOTICE

When using this procedure, caution should be used as ice chips can form from drops of water which could cause the unit to burst if starting before completely thawed.

Troubleshooting

Problem	Cause	Solution
Engine will not start.	Various engine problems.	Refer to the engine manual accompanying your unit.
	Unit components are frozen.	Allow to thaw. If any part of the unit becomes frozen; excessive pressure may build up in the unit which could cause the unit to burst resulting in possible serious injury to the operator or bystanders.
No discharge at nozzle when trigger mechanism is squeezed.	Inadequate water supply.	Ensure hose is 3/4" (19.05mm) diameter and incoming water supply is turned on.
Low or fluctuating pressure.	Kink in water inlet hose.	Remove kink.
	Kink in high pressure discharge hose.	Replace hose.
	Water inlet screen obstructed.	Remove screen, clean or replace.
	Pump sucking air. (Prime eliminated)	Tighten all water intake connections. Eliminate leaks in intake line.
	Not in high pressure mode.	Insert a high pressure nozzle.
	Obstructed or worn spray nozzle.	Remove, clean or replace.
	Damaged or obstructed valve assembly on pump.	Remove, inspect, clean or replace.
	Pump packing worn.	Replace packings.
Water is leaking from the "Heat Dump Valve".	Bypass valve not operating correctly.	Repair or replace.
	Water temperature is too high.	Do not allow the unit to operate in the bypass mode (with trigger gun closed) for more than 3 minutes.
Oil appears milky or foamy.	Defective valve.	Replace.
	Water in oil.	Change pump oil. Fill to proper level.
Oil leaking from unit.	Do Not Use.	Contact Customer Service.
Detergent will not siphon into Low Pressure Detergent mode.	Detergent strainer is not completely submerged in detergent solution.	Check, submerge if necessary.
	Detergent strainer is obstructed.	Inspect, clean or replace.
	Detergent hose cut, obstructed.	Inspect, clean or replace.
	Detergent adjusting knob on pump turned to closed position. (If applicable.)	Open adjusting knob. Refer to "Cleaning with Detergents" pg.13.
	Not in low pressure mode.	Insert 6540° (BLACK) nozzle.
	Nozzle assembly is plugged.	Clean or replace.
	Too many high pressure hose extensions attached to the water outlet.	Use one extension maximum.
Water flows back into detergent container.	Ball and Spring in Venturi stuck.	Remove, clean or replace.
	Ball and Spring in Venturi reversed, missing or corroded.	Remove, clean or replace.
Water flows from the nozzle when the trigger gun is locked in the "OFF" position.	Gun is malfunctioning.	Repair or replace.

PUMP SERVICE: 2525 MODEL PRESSURE WASHERS

Repair kits are available. See the Parts List, page 24. For the best results, use all parts in kits.

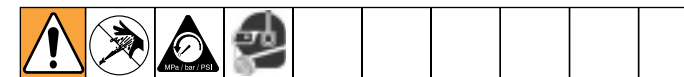

Follow Shutdown Procedure, page 13, to relieve system pressure.

- Drain and refill pump after 25 hours of operation.

For Outlet Valves

1. Remove hex plug from the manifold using a 14mm wrench.
2. Examine o-ring located under hex plug. Replace if cut or distorted.
3. Remove valve assembly from cavity. The assembly may come apart!
4. Install new valve, o-ring and hex plug. Torque to 14.75 ft-lb (20 Nm)

Note: Re-torque the plug after 5 hours operation.

For Inlet Valves

1. Remove 4 hex bolts from the manifold using a 6mm hex bit.
2. Carefully separate manifold from crankcase. You may have to lightly tap the manifold with a soft mallet to loosen it.
3. Using a screwdriver, press valves out of the manifold through the 3 holes located on the backside of the manifold (look for the stainless valve seats through the holes).
4. Remove the valve.
5. Install new o-ring. Then install new valve assembly. Reinsert brass plugs.
6. Reinstall manifold to pump. Torque hex bolts to 14.75 ft-lb (20 Nm).

Servicing Plungers or Internal Bearings

1. Damage to the plungers or any internal parts in the pump housing is considered a catastrophic failure and is not recommended for service. Replace pump if necessary.

Servicing V-Packings

1. Remove manifold as described in Valve Replacement Section.
2. Remove white retaining ring, this may be stuck on the piston.
3. Remove packing from manifold.
4. Inspect all parts and replace as necessary.
5. Thoroughly clean packing cavities and inspect for damage.
6. Lightly grease packing cavities. Replace packings in the following order:
 - packing
 - retainer ring

NOTICE

Packings must be installed in the proper order and facing the correct direction. Improperly installed parts will cause the pump to malfunction.

7. Remove brass retainer located around the piston.
8. Remove the outer and inner o-rings on the brass retainer.
9. Replace o-rings, reinstall brass retainer around piston.
10. Reassemble manifold. Torque hex bolt to 14.75 ft-lb (20 Nm).

PUMP SERVICE: 2730 MODEL PRESSURE WASHERS

Repair kits are available. See the Parts List, page 28 (2730B). For the best results, use all parts in kits.



Follow Shutdown Procedure, page 13, to relieve system pressure.

- Drain and refill pump after 25 hours of operation.

Valves

For a set of six valves, order Valve Assembly Kit 804402.

1. Remove hex plug from the manifold using a 22mm wrench.
2. Examine o-ring located under hex plug. Replace if cut or distorted.
3. Remove valve assembly from cavity. The assembly may come apart!
4. Install new valve, o-ring and hex plug. Torque to 60 ft-lb (81 Nm)

Note: Retorque the plug after 5 hours operation.

Pumping Section

1. Remove capscrews and lock washers from manifold.
2. Carefully separate manifold from the crankcase. You may have to lightly tap the manifold with a soft mallet to loosen it.

NOTICE

To avoid damage to plunger or seals, keep manifold properly aligned with the ceramic plungers when you remove it.

3. Carefully examine each plunger for any scoring or cracking. Replace as necessary.

Servicing Plungers

1. Loosen plunger retaining nut five or six turns using a 13mm wrench. Push plunger toward the crankcase to separate plunger and retaining screw.
2. Remove nut from plunger and examine and clean o-ring, backup ring, and copper bearing/gasket washer.
3. Remove plunger and flinger from plunger shaft. Clean parts as necessary.
4. Inspect plunger shaft for oil leaks from crankcase. If leaking is obvious, replace oil seals. Otherwise, DO NOT remove these seals because they cannot be reused. Oil Seal Kits are available for replacing seals.

5. Lightly grease the flinger (and oil seal if it is being replaced) on plunger shaft. Then install plunger.
6. Lightly grease the retaining screw and outer end of the plunger. Place washer, o-ring and backup ring around screw and install nut through plunger. Torque to 11.0 ft-lb (15 Nm).

Note: If replacing packings, see Servicing V-Packings.

7. Lubricate outside of each plunger. Slide the manifold on the crankcase, being careful not to damage seals.
8. Install capscrews and washers finger tight. Torque screws to 8.8 ft-lb (12 Nm) following the tightening pattern in the following figure.

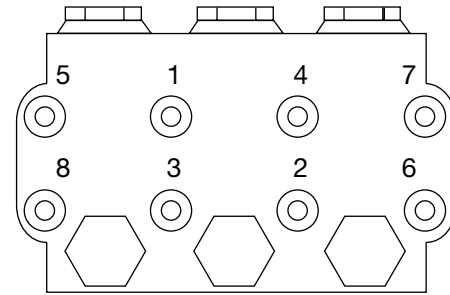

NOTICE

Uneven tightening could cause the manifold to bind or jam.

Servicing V-Packings

1. Remove manifold as described in Pumping Section.
2. Carefully pull packing retainer from manifold. Examine o-ring. Replace o-ring if cut or damaged.
3. Remove V-packing and head ring. Pull out retainer ring. Remove second V-packing and second head ring.
4. Inspect all parts and replace as necessary.
5. Thoroughly clean packing cavities and inspect for damage.
6. Lightly grease packing cavities. Replace packings in the following order:

- head ring
- v-packing
- intermediate ring
- head ring
- v-packing
- packing retainer
- o-ring in retainer groove

NOTICE

Packings must be installed in the proper order and facing the correct direction. Improperly installed parts will cause the pump to malfunction.

7. Reassemble manifold following procedure described in Servicing Plungers.

PUMP SERVICE: 3030 MODEL PRESSURE WASHERS

Repair kits are available. See the Parts List, page 32, 34. For the best results, use all parts in kits.



Follow Shutdown Procedure, page 13, to relieve system pressure.

- Drain and refill pump-after 25 hours of operation.

Valves

For a set of six valves, order Valve Assembly Kit 804402.

1. Remove hex plug from the manifold using a 27mm wrench.
2. Examine o-ring located under hex plug. Replace if cut or distorted.
3. Remove valve assembly from cavity. The assembly may come apart!
4. Install new valve, o-ring and hex plug. Torque to 73 ft-lb (99 Nm).

Note: Retorque the plug after 5 hours operation.

Pumping Section

1. Remove capscrews and lock washers from manifold.
2. Carefully separate manifold from the crankcase. You may have to lightly tap the manifold with a soft mallet to loosen it.

NOTICE

To avoid damage to plunger or seals, keep manifold properly aligned with the ceramic plungers when you remove it.

3. Carefully examine each plunger for any scoring or cracking. Replace as necessary.

Servicing Plungers

1. Loosen plunger retaining nut five or six turns using a 13mm wrench. Push plunger toward the crankcase to separate plunger and retaining screw.
2. Remove nut from plunger and examine and clean o-ring, backup ring, and copper bearing/gasket washer.
3. Remove plunger and flinger from plunger shaft. Clean parts as necessary.
4. Inspect plunger shaft for oil leaks from crankcase. If leaking is obvious, replace oil seals. Otherwise, DO NOT remove these seals because they cannot be reused. Oil Seal Kits are available for replacing seals.
5. Lightly grease the flinger (and oil seal if it is being replaced) on plunger shaft. Then install plunger.

6. Lightly grease the retaining screw and outer end of the plunger. Place washer, o-ring and backup ring around screw and install nut through plunger. Torque to 11.0 ft-lb (15 Nm).

Note: If replacing packings, see Servicing V-Packings.

7. Lubricate outside of each plunger. Slide the manifold on the crankcase, being careful not to damage seals.
8. Install caP screws and washers finger tight. Torque screws 14.7 ft-lb (20 Nm) following the tightening pattern in the following figure.

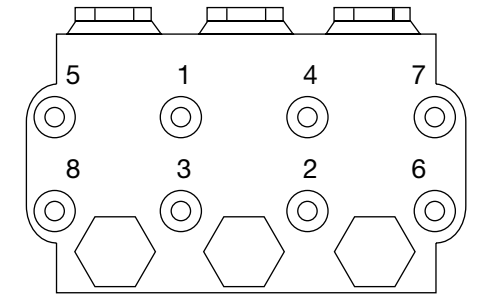

NOTICE

Uneven tightening could cause the manifold to bind or jam.

Servicing V-Packings

Two packing kits are available: one kit contains packings only. The other includes packings, rings and retainers.

1. Remove manifold as described in Pumping Section.
2. Carefully pull packing retainer from manifold. Examine o-ring. Replace o-ring if cut or damaged.
3. Remove V-packing and head ring. Pull out retainer ring. Remove second V-packing and second head ring.
4. Inspect all parts and replace as necessary.
5. Thoroughly clean packing cavities and inspect for damage.
6. Lightly grease packing cavities. Replace packings in the following order:

- head ring
- v-packing
- intermediate ring
- head ring
- v-packing
- packing retainer
- o-ring in retainer groove

NOTICE

Packings must be installed in the proper order and facing the correct direction. Improperly installed parts will cause the pump to malfunction.

7. Reassemble manifold following procedure described in Servicing Plungers.

Pressure Washer - Parts

262305- Model 2525DD

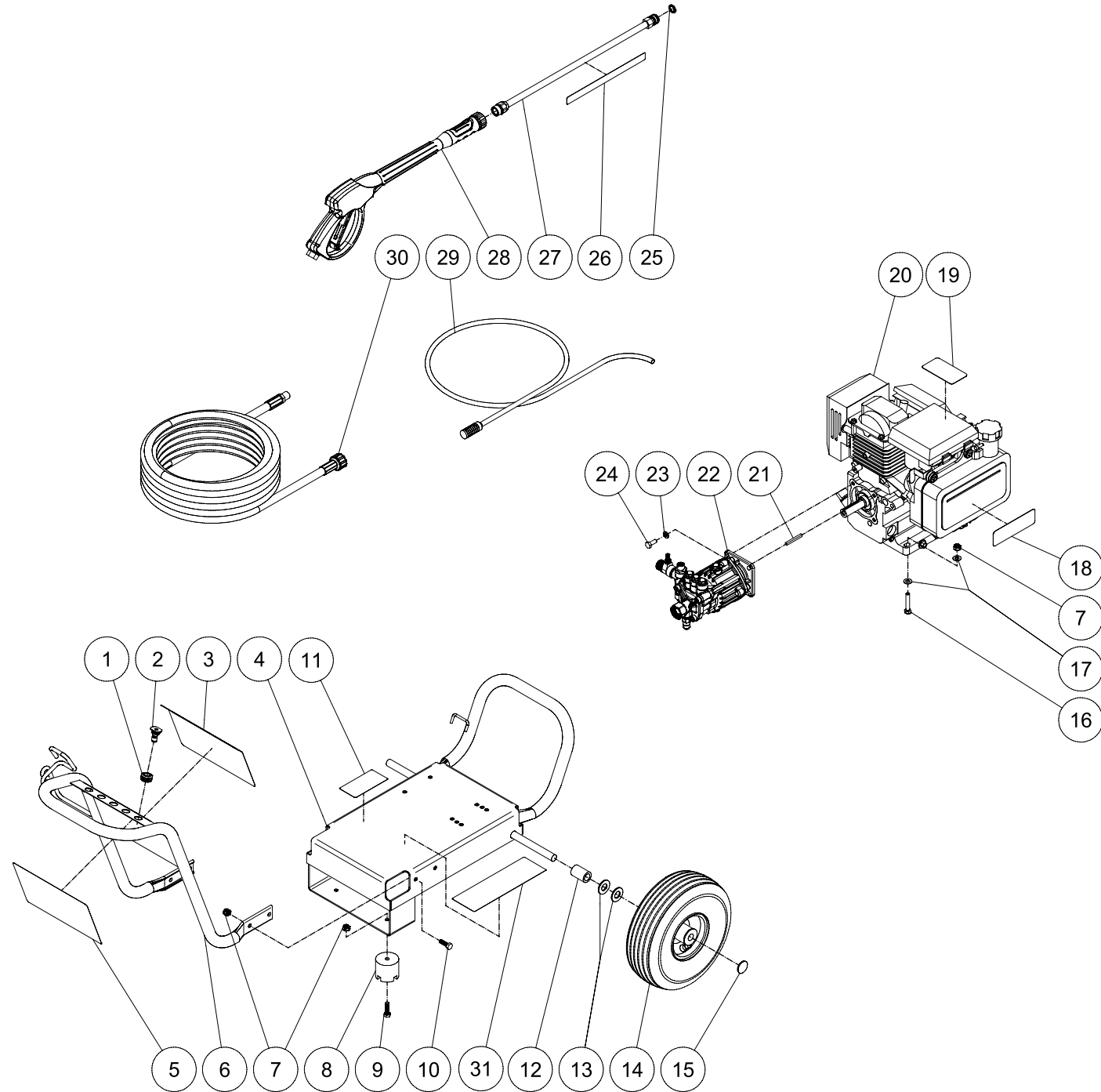

Pressure Washer - Parts

262305- Model 2525DD

DESCRIPTION	PART #	QTY	DESCRIPTION	PART #	QTY
1 GROMMET	16E489	5	15 CAP	16E491	2
2 NOZZLE, 0°	805535	1	16 BOLT	802127	4
- NOZZLE, 15°	805536	1	17 WASHER	107194	8
- NOZZLE, 40°	805538	1	18▲DECAL - RISK OF FIRE (E/S/F)	N/A	1
- NOZZLE, DETERGENT	805634	1	19▲DECAL - RISK OF BURNS (E/S/F)	N/A	1
3 DECAL - AIRLESSCO 2525DD	16E229	1	20 ENGINE	16E657	1
4 BASEPLATE	16E506	1	21 KEY	197792	1
5▲ DECAL - WARNING/CAUTION (E/S/F)	N/A	1	22 PUMP	24E735	1
6 HANDLE	16E515	1	23 LOCKWASHER	100214	4
7 LOCKNUT	111040	10	24 BOLT	108842	4
8 ISOLATOR	16E475	2	25 O-RING	154594	1
9 BOLT	100521	2	26▲DECAL - RISK OF INJECTION (E/S/F)	N/A	1
10 BOLT	114251	4	27 LANCE ASSEMBLY	118124	1
11 DECAL- SILVER STICKER	N/A	1	28 GUN & WAND - 4000 PSI	246674	1
12 SPACER	16E512	2	29 DETERGENT HOSE	117760	1
13 WASHER	111841	4	30 HOSE	16E286	1
14 WHEEL	16E476	2	31 DECAL - OPERATIONS - (E/S/F)	N/A	1
			32▲DECAL SET, SAFETY	16E947	1
			INCLUDES 5, 18, 19, 26, 31		

▲REPLACEMENT WARNING DECALS AVAILABLE AT NO COST.

Pump Assembly - Parts - Series A

24E735 (for use with Model 2525DD)

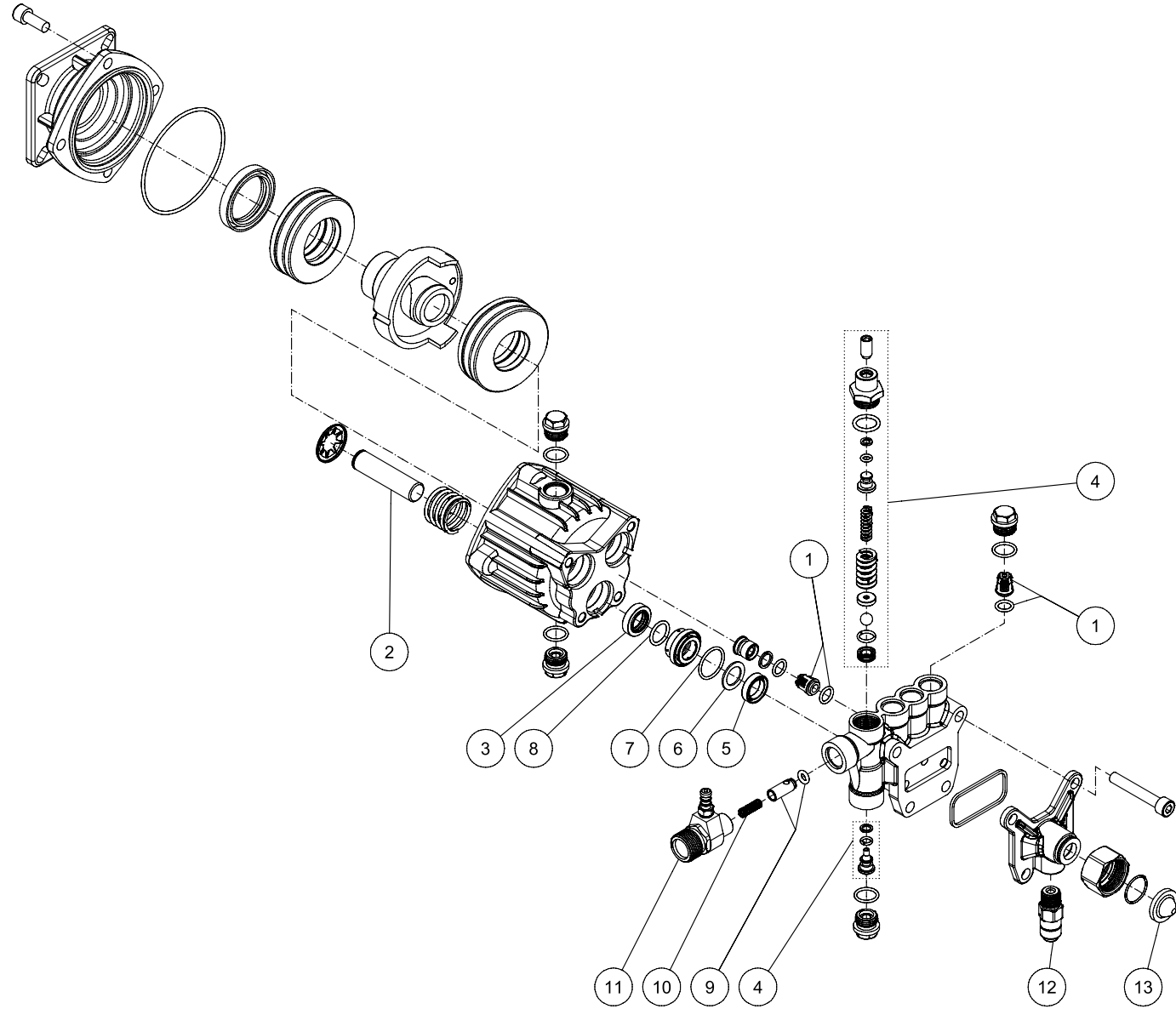

Pump Assembly - Parts

24E735 (for use with Model 2525DD)

DESCRIPTION	PART #	QTY
KIT, REPAIR, VALVES INCLUDES 1	24E736	6
KIT, REPAIR, PLUNGER INCLUDES 2	24E737	3
KIT, REPAIR, OIL SEAL INCLUDES 3	24E738	3
KIT, REPAIR, UNLOADER INCLUDES 4	24E739	1
KIT, REPAIR, PACKINGS INCLUDES 5, 6, 7, 8	24E740	3
KIT, REPAIR, CHEMICAL INJECTOR INCLUDES 9, 10, 11	24E741	1
THERMAL RELIEF VALVE INCLUDES 12	117759	1
FILTER, INLET INCLUDES 13	801112	1

Pump Assembly - Parts - Series B

24R713 (for use with Model 2525DD)

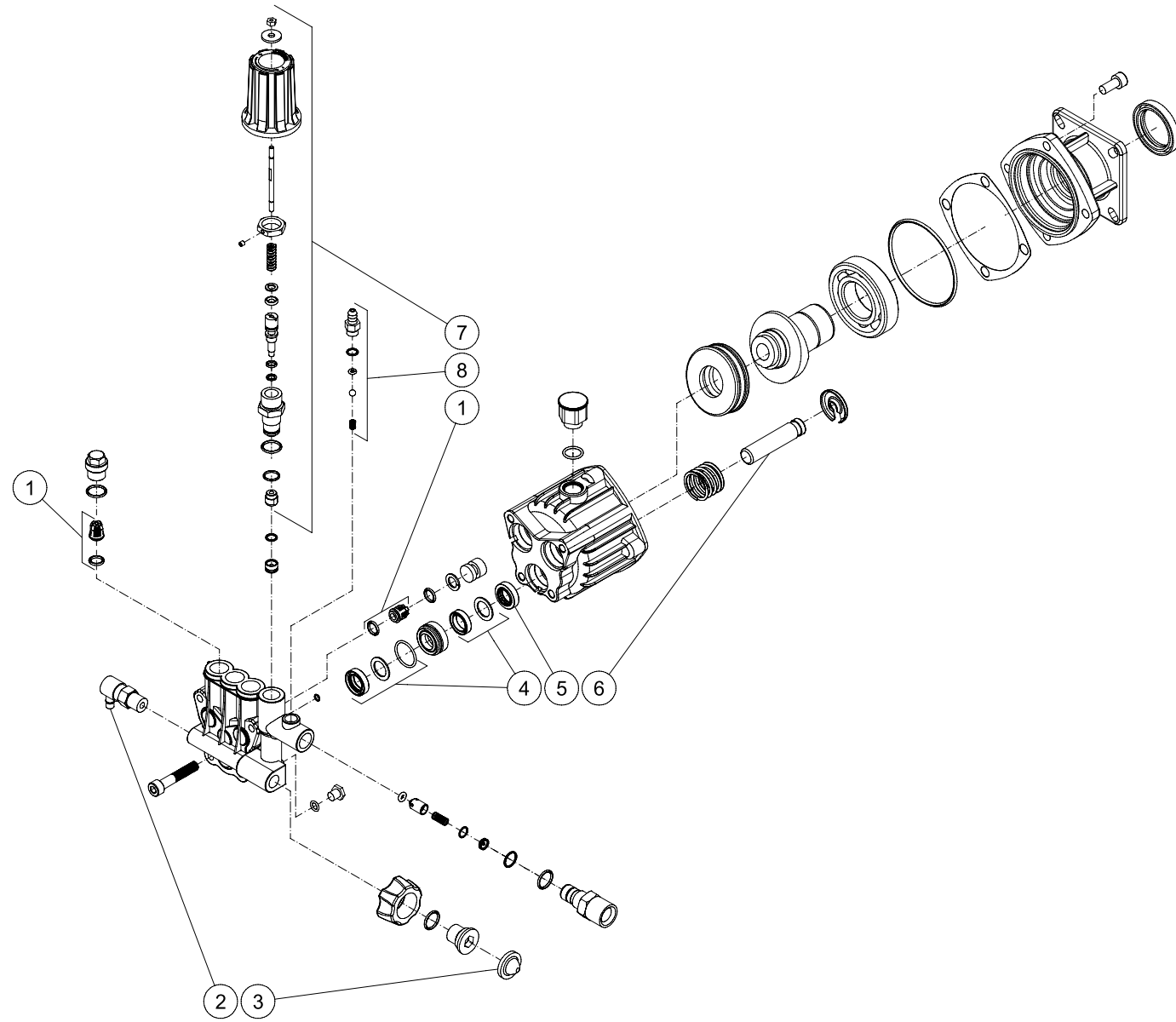

Pump Assembly - Parts

24R713 (for use with Model 2525DD)

DESCRIPTION	PART #	QTY
KIT, REPAIR, VALVES INCLUDES 1	24R715	6
THERMAL RELIEF VALVE INCLUDES 2	117759	1
FILTER, INLET INCLUDES 3	801112	1
KIT, REPAIR, PACKINGS INCLUDES 4	24R718	3
KIT, REPAIR, OIL SEAL INCLUDES 5	16V292	3
KIT, REPAIR, PISTON INCLUDES 6	16V302	3
KIT, REPAIR, UNLOADER INCLUDES 7	24R714	1
KIT, REPAIR, CHEMICAL INJECTOR INCLUDES 8	24R716	1

Pressure Washer - Parts

262306- Model 2730DD

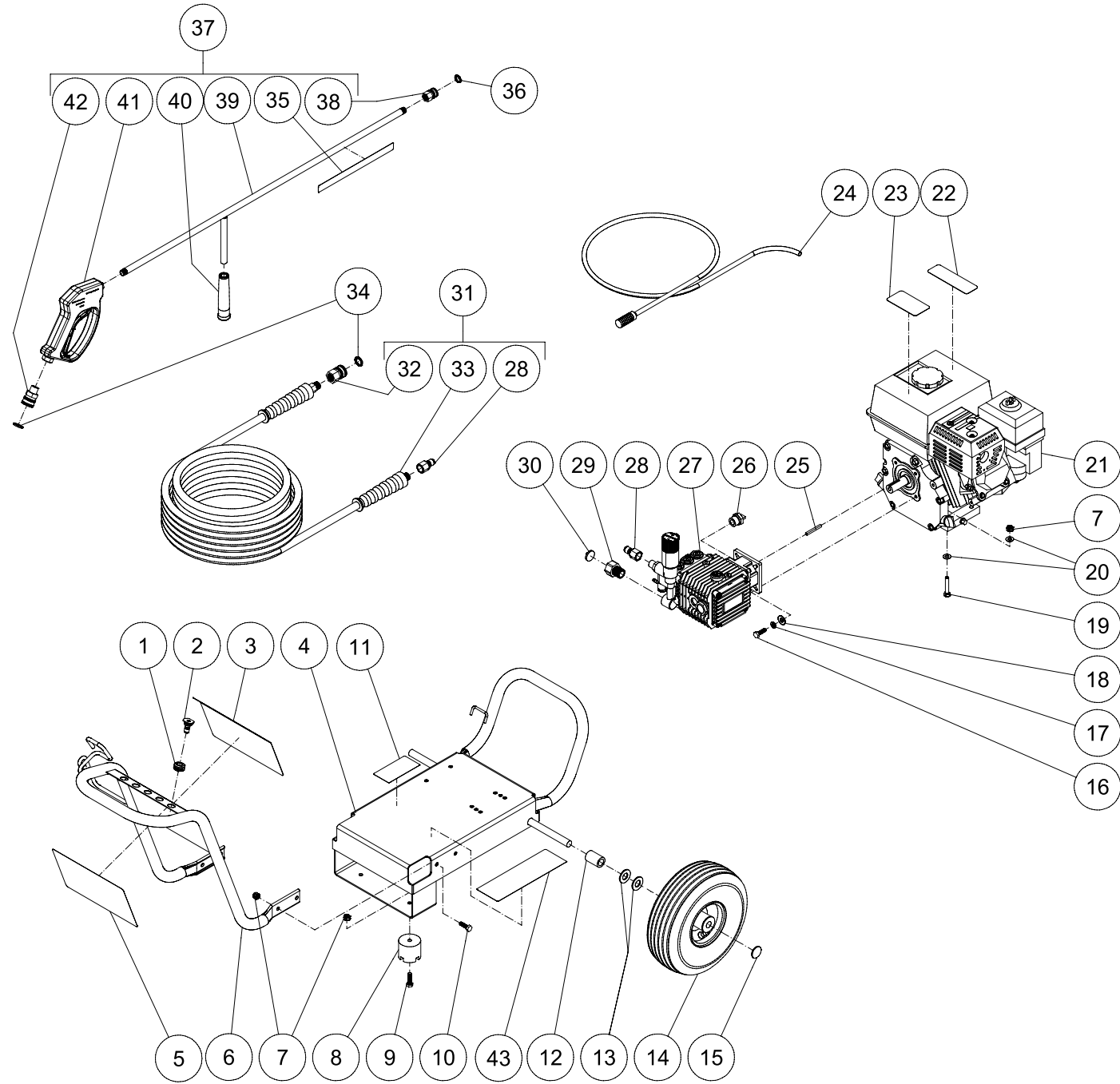

Pressure Washer - Parts

262306- Model 2730DD

DESCRIPTION	PART#	QTY	DESCRIPTION	PART#	QTY
1 GROMMET	16E489	5	21 ENGINE	16E658	1
2 NOZZLE, 0°	805535	1	22▲DECAL - RISK OF FIRE (E/S/F)	N/A	1
- NOZZLE, 15°	805536	1	23▲DECAL - RISK OF BURNS (E/S/F)	N/A	1
- NOZZLE, 25°	805537	1	24 DETERGENT HOSE	117760	1
- NOZZLE, 40°	805538	1	25 KEY	197792	1
- NOZZLE, DETERGENT	805634	1	26 RELIEF VALVE	116461	1
3 DECAL - AIRLESSCO 2730DD	16E230	1	27 PUMP	244749	1
4 BASEPLATE	16E506	1	28 QUICK CONNECT	197428	2
5▲DECAL - WARNING/CAUTION (E/S/F)	N/A	1	29 SWIVEL	16E662	1
6 HANDLE	16E515	1	30 FILTER	801112	1
7 LOCKNUT	111040	10	31 HOSE ASSEMBLY	244783	1
8 ISOLATOR	16E475	2	32 QC SOCKET	N/A	1
9 BOLT	100521	2	33 HOSE	N/A	1
10 BOLT	114251	4	34 O-RING	156082	2
11 DECAL - SILVER STICKER	N/A	1	35▲DECAL - RISK OF INJECTION (E/S/F)	N/A	1
12 SPACER	16E512	2	36 O-RING	154594	1
13 WASHER	111841	5	37 GUN/WAND ASSEMBLY	24E723	1
14 WHEEL	16E476	2	38 QUICK CONNECT	N/A	1
15 CAP	16E491	2	39 WAND	N/A	1
16 BOLT	100184	4	40 GRIP	N/A	1
17 LOCKWASHER	100214	4	41 GUN	N/A	1
18 WASHER	107194	4	42 QUICK CONNECT SOCKET	N/A	1
19 BOLT	802127	4	43 DECAL - OPERATIONS - (E/S/F)	N/A	1
20 WASHER	107194	8	44▲DECAL SET, SAFETY	16E947	1
			INCLUDES 5, 22, 23, 35, 43		

▲REPLACEMENT WARNING DECALS AVAILABLE AT NO COST.

Pump Assembly - Parts

244749 (for use with Model 2730DD)

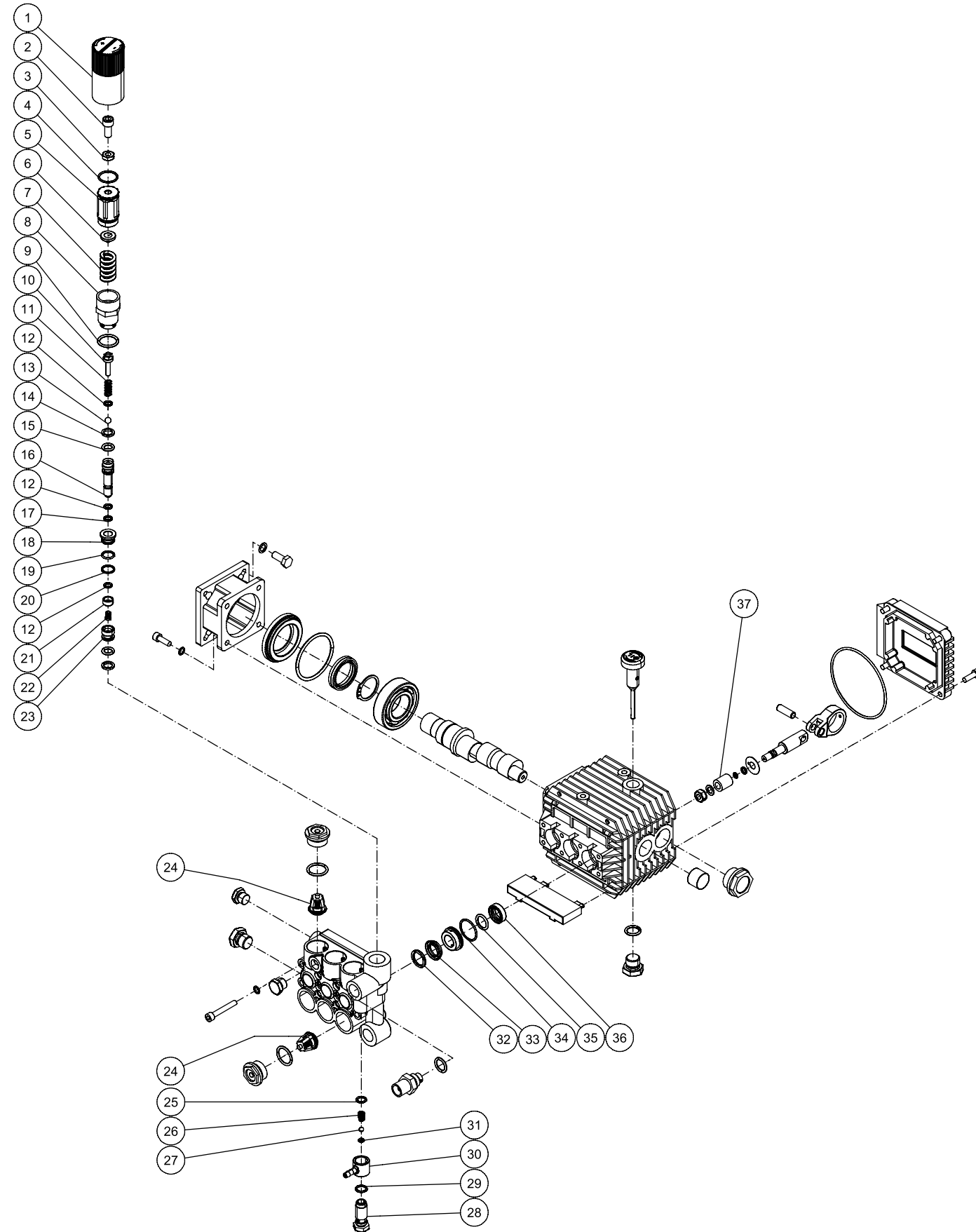

Pump Assembly - Parts

244749 (for use with Model 2730DD)

DESCRIPTION	PART #	QTY
KIT, REPAIR, VALVES INCLUDES 24	804402	6
KIT, REPAIR, OIL SEAL INCLUDES 36	804033	3
KIT, REPAIR, PLUNGER INCLUDES 37	804011	3
KIT, REPAIR, PACKINGS INCLUDES 32, 33, 34, 35	804037	3
KIT, REPAIR, CHEMICAL INJECTOR INCLUDES 25-31	24E748	1
KIT, REPAIR, UNLOADER INCLUDES 1-23	244803	1

Pressure Washer - Parts

262308- Model 3030DD

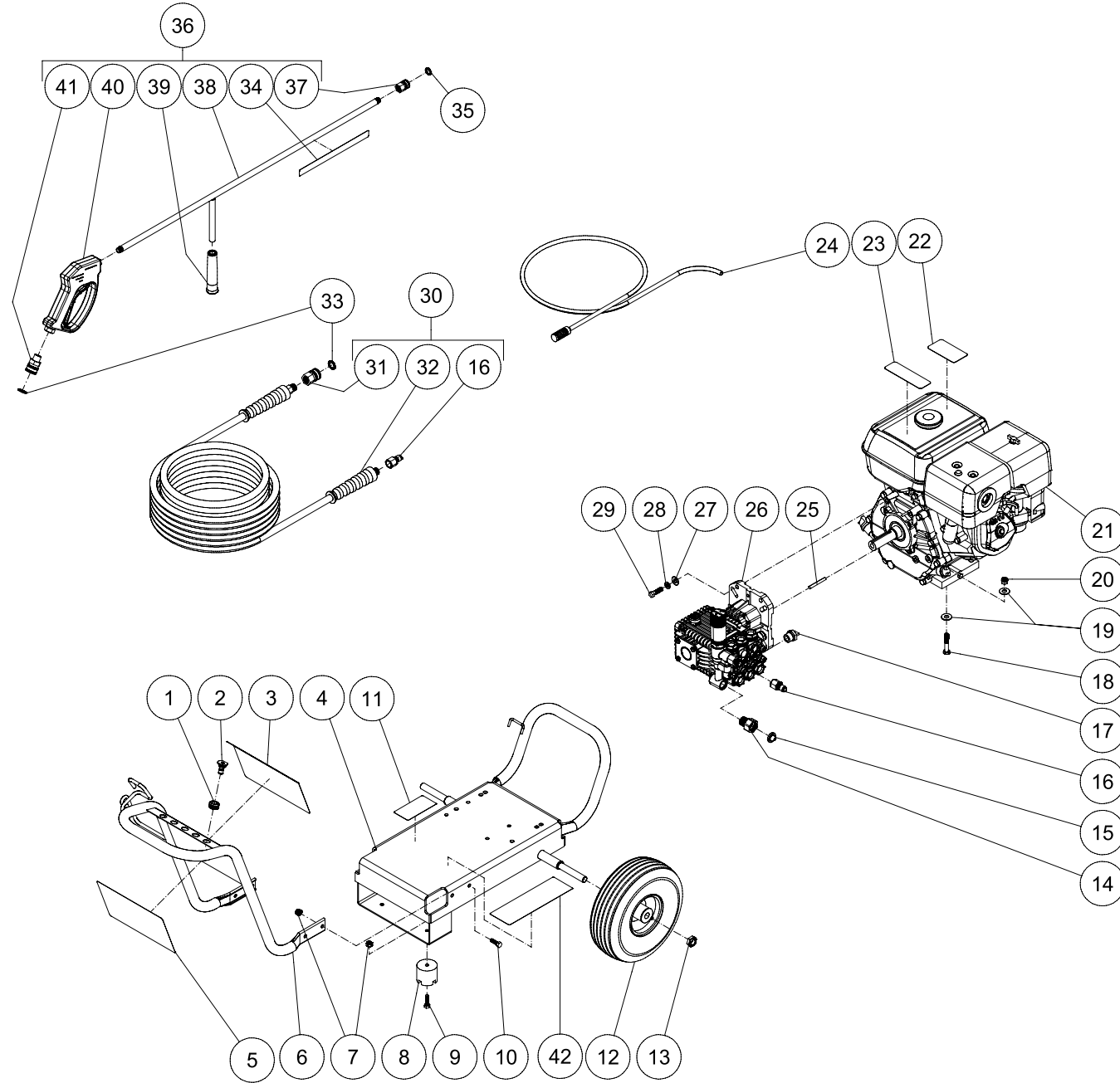

Pressure Washer - Parts

262308- Model 3030DD

DESCRIPTION	PART #	QTY	DESCRIPTION	PART #	QTY
1 GROMMET	16E489	5	21 ENGINE	16E659	1
2 NOZZLE, 0°	805539	1	22▲DECAL - RISK OF BURNS (E/S/F)	N/A	1
- NOZZLE, 15°	805540	1	23▲DECAL - RISK OF FIRE (E/S/F)	N/A	1
- NOZZLE, 25°	805541	1	24 DETERGENT HOSE	117760	1
- NOZZLE, 40°	805542	1	25 KEY	801137	1
- NOZZLE, DETERGENT	805634	1	26 PUMP	24E753	1
3 DECAL - AIRLESSCO 3030DD	16E231	1	27 WASHER	107194	4
4 FRAME	16E507	1	28 LOCKWASHER	100133	4
5▲DECAL - WARNING/CAUTION (E/S/F)	N/A	1	29 BOLT	100004	4
6 HANDLE	16E515	1	30 HOSE ASSEMBLY	244783	1
7 LOCKNUT	111040	6	31 QC SOCKET	N/A	1
8 ISOLATOR	16E475	2	32 HOSE	N/A	1
9 BOLT	100521	2	33 O-RING	156082	2
10 BOLT	114251	4	34▲DECAL - RISK OF INJECTION (E/S/F)	N/A	1
11 DECAL- SILVER STICKER	N/A	1	35 O-RING	154594	1
12 WHEEL	16E476	2	36 GUN/WAND ASSEMBLY	24E723	1
13 LOCKNUT	119554	2	37 QUICK CONNECT	N/A	1
14 SWIVEL	16E662	1	38 WAND	N/A	1
15 FILTER	801112	1	39 GRIP	N/A	1
16 QUICK CONNECT	197428	2	40 GUN	N/A	1
17 RELIEF VALVE	116461	1	41 QUICK CONNECT SOCKET	N/A	1
18 BOLT	111803	4	42 DECAL - OPERATIONS - (E/S/F)	N/A	1
19 WASHER	100731	8	43▲DECAL SET, SAFETY	16E947	1
20 LOCKNUT	101566	4			
			INCLUDES 5, 22, 23, 34, 42		

▲REPLACEMENT WARNING DECALS AVAILABLE AT NO COST.

Pump Assembly - Parts

24E753 (for use with Model 3030DD)

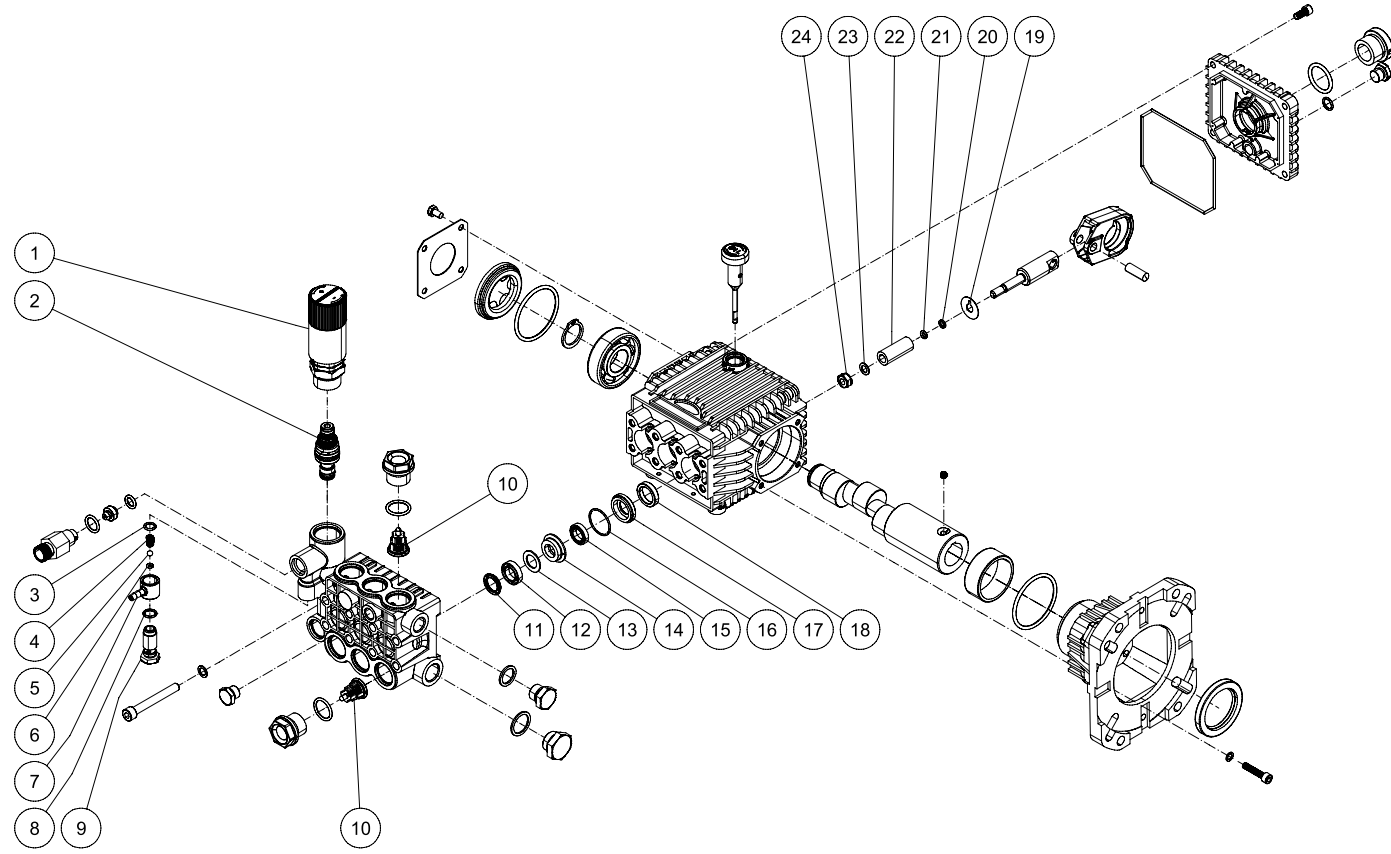

Pump Assembly - Parts

24E753 (for use with Model 3030DD)

DESCRIPTION	PART #	QTY
KIT, REPAIR, VALVES INCLUDES 10	804402	6
KIT, REPAIR, OIL SEAL INCLUDES 18	24E744	3
KIT, PLUNGER INCLUDES 22	24E745	3
KIT, REPAIR, PACKINGS INCLUDES 11-17	24E746	3
KIT, REPAIR, PLUNGER INCLUDES 19, 20, 21, 23, 24	24E747	3
KIT, REPAIR, CHEMICAL INJECTOR INCLUDES 3-9	24E748	1
KIT, REPAIR, UNLOADER INCLUDES 1, 2	244804	1

Airlessco Standard Warranty

Airlessco warrants all equipment referenced in this document which is manufactured by Airlessco and bearing its name to be free from defects in material and workmanship on the date of sale to the original purchaser for use. With the exception of any special, extended, or limited warranty published by Airlessco, Airlessco will, for a period of twelve months from the date of sale, repair or replace any part of the equipment determined by Airlessco to be defective. This warranty applies only when the equipment is installed, operated and maintained in accordance with Airlessco's written recommendations.

This warranty does not cover, and Airlessco shall not be liable for general wear and tear, or any malfunction, damage or wear caused by faulty installation, misapplication, abrasion, corrosion, inadequate or improper maintenance, negligence, accident, tampering, or substitution of non-Airlessco component parts. Nor shall Airlessco be liable for malfunction, damage or wear caused by the incompatibility of Airlessco equipment with structures, accessories, equipment or materials not supplied by Airlessco, or the improper design, manufacture, installation, operation or maintenance of structures, accessories, equipment or materials not supplied by Airlessco.

This warranty is conditioned upon the prepaid return of the equipment claimed to be defective to an authorized Airlessco distributor for verification of the claimed defect. If the claimed defect is verified, Airlessco will repair or replace free of charge any defective parts. The equipment will be returned to the original purchaser transportation prepaid. If inspection of the equipment does not disclose any defect in material or workmanship, repairs will be made at a reasonable charge, which charges may include the costs of parts, labor, and transportation.

THIS WARRANTY IS EXCLUSIVE, AND IS IN LIEU OF ANY OTHER WARRANTIES, EXPRESS OR IMPLIED, INCLUDING BUT NOT LIMITED TO WARRANTY OF MERCHANTABILITY OR WARRANTY OF FITNESS FOR A PARTICULAR PURPOSE.

Airlessco's sole obligation and buyer's sole remedy for any breach of warranty shall be as set forth above. The buyer agrees that no other remedy (including, but not limited to, incidental or consequential damages for lost profits, lost sales, injury to person or property, or any other incidental or consequential loss) shall be available. Any action for breach of warranty must be brought within two (2) years of the date of sale.

Airlessco **MAKES NO WARRANTY, AND DISCLAIMS ALL IMPLIED WARRANTIES OF MERCHANTABILITY AND FITNESS FOR A PARTICULAR PURPOSE, IN CONNECTION WITH ACCESSORIES, EQUIPMENT, MATERIALS OR COMPONENTS SOLD BUT NOT MANUFACTURED BY Airlessco.** These items sold, but not manufactured by Airlessco (such as electric motors, switches, hose, etc.), are subject to the warranty, if any, of their manufacturer. Airlessco will provide purchaser with reasonable assistance in making any claim for breach of these warranties.

In no event will Airlessco be liable for indirect, incidental, special or consequential damages resulting from Airlessco supplying equipment hereunder, or the furnishing, performance, or use of any products or other goods sold hereto, whether due to a breach of contract, breach of warranty, the negligence of Airlessco, or otherwise.

For Airlessco Canada Customers

The Parties acknowledge that they have required that the present document, as well as all documents, notices and legal proceedings entered into, given or instituted pursuant hereto or relating directly or indirectly hereto, be drawn up in English. Les parties reconnaissent avoir convenu que la rédaction du présente document sera en Anglais, ainsi que tous documents, avis et procédures judiciaires exécutés, donnés ou intentés, à la suite de ou en rapport, directement ou indirectement, avec les procédures concernées.

Airlessco Information

TO PLACE AN ORDER OR FOR SERVICE, contact your Airlessco distributor, or call 1-800-223-8213 to identify the nearest distributor.

*All written and visual data contained in this document reflects the latest product information available at the time of publication.
Airlessco reserves the right to make changes at any time without notice.*

For patent information, see www.graco.com/patents.

This manual contains English. *MM 3A0819*

Airlessco, 3501 N. 4th Avenue, Sioux Falls, SD 57104

www.airlessco.com
Revised February 2013