

# SP200 Electric Airless Sprayer

333089A

EN

**- For Portable Spray Applications of Architectural Paints and Coatings -**  
**- Not approved for Use in Explosive Atmospheres or Hazardous Locations -**





**Important Safety Instructions**

Read all warnings and instructions in this manual. Save these instructions.

**Model: 24U967, Series A**

Maximum Working Pressure: 3000 psi (207 bar, 21 MPa)

						
<ul style="list-style-type: none"><li>• Use only water-based or mineral spirit-type materials. Do not use materials having flash points lower than 70°F (21°C). This includes but is not limited to acetone, xylene, toluene, and naphtha. For more information about your material, request MSDS from the supplier.</li><li>• Spraying flammable or combustible materials in a factory or fixed location must comply with NFPA 33 and OSHA 1910.94(c) requirements in the USA and with all similar local regulations in other countries.</li></ul>						

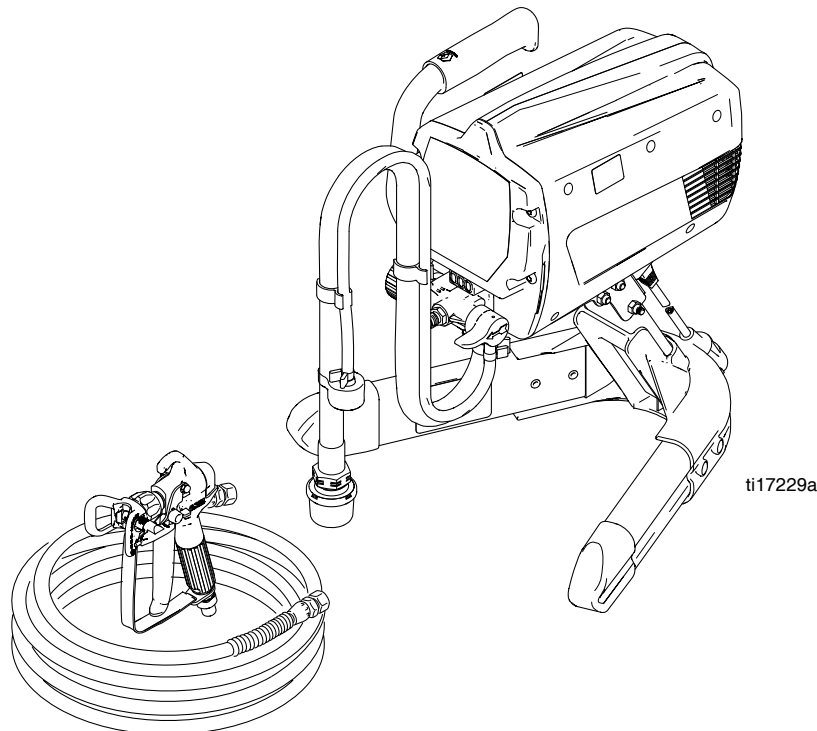

# Contents

<b>Notes</b> .....	<b>7</b>	<b>Shutdown and Cleaning</b> .....	<b>18</b>
<b>Component Identification</b> .....	<b>8</b>	Pail Flushing .....	18
Component Identification .....	9	Cleaning Gun Filter .....	20
<b>Grounding and Electric Requirements</b> .....	<b>10</b>	<b>Storage</b> .....	<b>21</b>
Thermal Overload .....	10	Short Term Storage .....	21
<b>Operation</b> .....	<b>11</b>	Long Term Storage .....	21
Trigger Lock .....	11	<b>Maintenance and Service</b> .....	<b>23</b>
Pressure Relief Procedure .....	11	Caring for Sprayer .....	23
<b>Setup</b> .....	<b>12</b>	Paint Hoses .....	23
Prime and Flush Storage Fluid .....	12	Tips .....	23
Install Tip and Guard on Gun .....	14	Pump Check Valves .....	23
Spraying Techniques .....	15	Pump Packings .....	23
Getting Started .....	15	<b>Troubleshooting</b> .....	<b>24</b>
Triggering Gun .....	15	<b>Parts</b> .....	<b>28</b>
Aiming Gun .....	15	<b>Technical Data</b> .....	<b>32</b>
Unclogging Spray Tip .....	16	<b>Notes</b> .....	<b>33</b>
Choosing the Correct Tip .....	17	<b>Airlessco Standard Warranty</b> .....	<b>34</b>
Uni-Tip Selection Chart .....	17		

# Warnings

The following warnings are for the setup, use, grounding, maintenance, and repair of this equipment. The exclamation point symbol alerts you to a general warning and the hazard symbols refer to procedure-specific risks. When these symbols appear in the body of this manual or on warning labels, refer back to these Warnings. Product-specific hazard symbols and warnings not covered in this section may appear throughout the body of this manual where applicable.

## ⚠️ WARNING



### GROUNDING

This product must be grounded. In the event of an electrical short circuit, grounding reduces the risk of electric shock by providing an escape wire for the electric current. This product is equipped with a cord having a grounding wire with an appropriate grounding plug. The plug must be plugged into an outlet that is properly installed and grounded in accordance with all local codes and ordinances.

- Improper installation of the grounding plug is able to result in a risk of electric shock.
- When repair or replacement of the cord or plug is required, do not connect the grounding wire to either flat blade terminal.
- The wire with insulation having an outer surface that is green with or without yellow stripes is the grounding wire.
- Check with a qualified electrician or serviceman when the grounding instructions are not completely understood, or when in doubt as to whether the product is properly grounded.
- Do not modify the plug provided; if it does not fit the outlet, have the proper outlet installed by a qualified electrician.
- This product is for use on a nominal 230V circuit and has a grounding plug similar to the plugs illustrated in the figure below.

230V

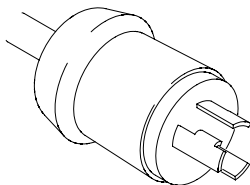

- Only connect the product to an outlet having the same configuration as the plug.
- Do not use an adapter with this product.

#### Extension Cords:

- Use only a 3-wire extension cord that has a grounding plug and a grounding receptacle that accepts the plug on the product.
- Make sure your extension cord is not damaged. If an extension cord is necessary, use 12 AWG (2.5 mm<sup>2</sup>) minimum to carry the current that the product draws.
- An undersized cord results in a drop in line voltage and loss of power and overheating.

# ! WARNING



## FIRE AND EXPLOSION HAZARD

Flammable fumes, such as solvent and paint fumes, in work area can ignite or explode. To help prevent fire and explosion:

- Do not spray or clean with materials having flash points lower than 70°F (21°C). Use water-based material or mineral spirits-type material only. For complete information about your material, request the MSDS from the material distributor or retailer.
- Do not spray flammable or combustible materials near an open flame or sources of ignition such as cigarettes, motors, and electrical equipment.
- Paint or solvent flowing through the equipment is able to result in static electricity. Static electricity creates a risk of fire or explosion in the presence of paint or solvent fumes. All parts of the spray system, including the pump, hose assembly, spray gun, and objects in and around the spray area shall be properly grounded to protect against static discharge and sparks. Use Graco conductive or grounded high-pressure airless paint sprayer hoses.
- Verify that all containers and collection systems are grounded to prevent static discharge. Do not use pail liners unless they are antistatic or conductive.
- Connect to a grounded outlet and use grounded extensions cords. Do not use a 3-to-2 adapter.
- Do not use a paint or a solvent containing halogenated hydrocarbons.
- Keep spray area well-ventilated. Keep a good supply of fresh air moving through the area. Keep pump assembly in a well ventilated area. Do not spray pump assembly.
- Do not smoke in the spray area.
- Do not operate light switches, engines, or similar spark producing products in the spray area.
- Keep area clean and free of paint or solvent containers, rags, and other flammable materials.
- Know the contents of the paints and solvents being sprayed. Read all Material Safety Data Sheets (MSDS) and container labels provided with the paints and solvents. Follow the paint and solvents manufacturer's safety instructions.
- Fire extinguisher equipment shall be present and working.
- Sprayer generates sparks. When flammable liquid is used in or near the sprayer or for flushing or cleaning, keep sprayer at least 20 feet (6 m) away from explosive vapors.















## SKIN INJECTION HAZARD

High-pressure spray is able to inject toxins into the body and cause serious bodily injury. In the event that injection occurs, **get immediate surgical treatment.**

- Do not aim the gun at, or spray any person or animal.
- Keep hands and other body parts away from the discharge. For example, do not try to stop leaks with any part of the body.
- Always use the nozzle tip guard. Do not spray without nozzle tip guard in place.
- Use Graco nozzle tips.
- Use caution when cleaning and changing nozzle tips. In the case where the nozzle tip clogs while spraying, follow the **Pressure Relief Procedure** for turning off the unit and relieving the pressure before removing the nozzle tip to clean.
- Do not leave the unit energized or under pressure while unattended. When the unit is not in use, turn off the unit and follow the **Pressure Relief Procedure** for turning off the unit.
- Check hoses and parts for signs of damage. Replace any damaged hoses or parts.
- This system is capable of producing 3000 psi. Use Graco replacement parts or accessories that are rated a minimum of 3000 psi.
- Always engage the trigger lock when not spraying. Verify the trigger lock is functioning properly.
- Verify that all connections are secure before operating the unit.
- Know how to stop the unit and bleed pressure quickly. Be thoroughly familiar with the controls.

# ! WARNING

 	<p><b>EQUIPMENT MISUSE HAZARD</b></p> <p>Misuse can cause death or serious injury.</p> <ul style="list-style-type: none"> <li>• Do not operate the unit when fatigued or under the influence of drugs or alcohol.</li> <li>• Do not exceed the maximum working pressure or temperature rating of the lowest rated system component. See <b>Technical Data</b> in all equipment manuals.</li> <li>• Use fluids and solvents that are compatible with equipment wetted parts. See Technical Data in all equipment manuals. Read fluid and solvent manufacturer's warnings. For complete information about your material, request MSDS from distributor or retailer.</li> <li>• Do not leave the work area while equipment is energized or under pressure.</li> <li>• Turn off all equipment and follow the <b>Pressure Relief Procedure</b> when equipment is not in use.</li> <li>• Check equipment daily. Repair or replace worn or damaged parts immediately with genuine manufacturer's replacement parts only.</li> <li>• Do not alter or modify equipment. Alterations or modifications may void agency approvals and create safety hazards.</li> <li>• Make sure all equipment is rated and approved for the environment in which you are using it.</li> <li>• Use equipment only for its intended purpose. Call your distributor for information.</li> <li>• Route hoses and cables away from traffic areas, sharp edges, moving parts, and hot surfaces.</li> <li>• Do not kink or over bend hoses or use hoses to pull equipment.</li> <li>• Keep children and animals away from work area.</li> <li>• Comply with all applicable safety regulations.</li> </ul>
  	<p><b>ELECTRIC SHOCK HAZARD</b></p> <p>This equipment must be grounded. Improper grounding, setup, or usage of the system can cause electric shock.</p> <ul style="list-style-type: none"> <li>• Turn off and disconnect power cord before servicing equipment.</li> <li>• Connect only to grounded electrical outlets.</li> <li>• Use only 3-wire extension cords.</li> <li>• Ensure ground prongs are intact on power and extension cords.</li> <li>• Do not expose to rain. Store indoors.</li> </ul>
	<p><b>PRESSURIZED ALUMINUM PARTS HAZARD</b></p> <p>Use of fluids that are incompatible with aluminum in pressurized equipment can cause serious chemical reaction and equipment rupture. Failure to follow this warning can result in death, serious injury, or property damage.</p> <ul style="list-style-type: none"> <li>• Do not use 1,1,1-trichloroethane, methylene chloride, other halogenated hydrocarbon solvents or fluids containing such solvents.</li> <li>• Many other fluids may contain chemicals that can react with aluminum. Contact your material supplier for compatibility.</li> </ul>
	<p><b>BURN HAZARD</b></p> <p>Equipment surfaces and fluid that is heated can become very hot during operation. To avoid severe burns:</p> <ul style="list-style-type: none"> <li>• Do not touch hot fluid or equipment.</li> </ul>

 <b>WARNING</b>	
 	<p><b>MOVING PARTS HAZARD</b></p> <p>Moving parts can pinch, cut or amputate fingers and other body parts.</p> <ul style="list-style-type: none"> <li>Keep clear of moving parts.</li> <li>Do not operate equipment with protective guards or covers removed.</li> <li>Pressurized equipment can start without warning. Before checking, moving, or servicing equipment, follow the <b>Pressure Relief Procedure</b> and disconnect all power sources.</li> </ul>
	<p><b>TOXIC FLUID OR FUMES HAZARD</b></p> <p>Toxic fluids or fumes can cause serious injury or death if splashed in the eyes or on skin, inhaled, or swallowed.</p> <ul style="list-style-type: none"> <li>Read MSDSs to know the specific hazards of the fluids you are using.</li> <li>Store hazardous fluid in approved containers, and dispose of it according to applicable guidelines.</li> </ul>
	<p><b>PERSONAL PROTECTIVE EQUIPMENT</b></p> <p>Wear appropriate protective equipment when in the work area to help prevent serious injury, including eye injury, hearing loss, inhalation of toxic fumes, and burns. This protective equipment includes but is not limited to:</p> <ul style="list-style-type: none"> <li>Protective eyewear, and hearing protection.</li> <li>Respirators, protective clothing, and gloves as recommended by the fluid and solvent manufacturer.</li> </ul>
	<p><b>CALIFORNIA PROPOSITION 65</b></p> <p>This product contains a chemical known to the State of California to cause cancer, birth defects or other reproductive harm. Wash hands after handling.</p>



## Component Identification





A	Airless spray gun	Dispenses fluid.
B	Power switch	Turns sprayer ON and OFF.
C	Pressure control knob	Increases (clockwise) and decreases (counter-clockwise) fluid pressure in pump, hose, and spray gun.
C1	Setting Indicator	To select function, align symbol on pressure control knob with setting indicator, page 11.
D	Pump fluid outlet fitting	Threaded connection for paint hose.
G	Suction tube	Draws fluid from paint pail into pump.
H	Prime tube (with diffuser)	Drains fluid in system during priming and pressure relief.
J	Prime/Spray valve	<ul style="list-style-type: none"> <li>• PRIME position directs fluid to prime tube.</li> <li>• SPRAY position directs pressurized fluid to paint hose.</li> <li>• Automatically relieves system pressure in overpressure situations.</li> </ul>
L	Inlet screen	Prevents debris from entering pump.
M	Paint hose	Transports high-pressure fluid from pump to spray gun.
N	Handle	Used to help transport sprayer.
Q	Tip guard	Reduces risk of fluid injection injury.
R	Reversible spray tip	<ul style="list-style-type: none"> <li>• Atomizes fluid being sprayed, forms spray pattern and controls fluid flow according to hole size.</li> <li>• Reverse unclogs plugged tips without disassembly.</li> </ul>
S	Gun trigger safety lever (page 11)	Prevents accidental triggering of spray gun.
T	Gun fluid inlet fitting	Threaded connection for paint hose.
V	Gun fluid filter	Filters fluid entering spray gun to reduce tip clogs.
X	Power cord	Supplies sprayer with electricity
Z	Pump priming button	Manually taps inlet ball to loosen if stuck.
AA	Plug Adapter	Adapts power cord to Australian electrical outlet.
AB	Plug Adapter Retainer	Retains plug adapter to power cord.

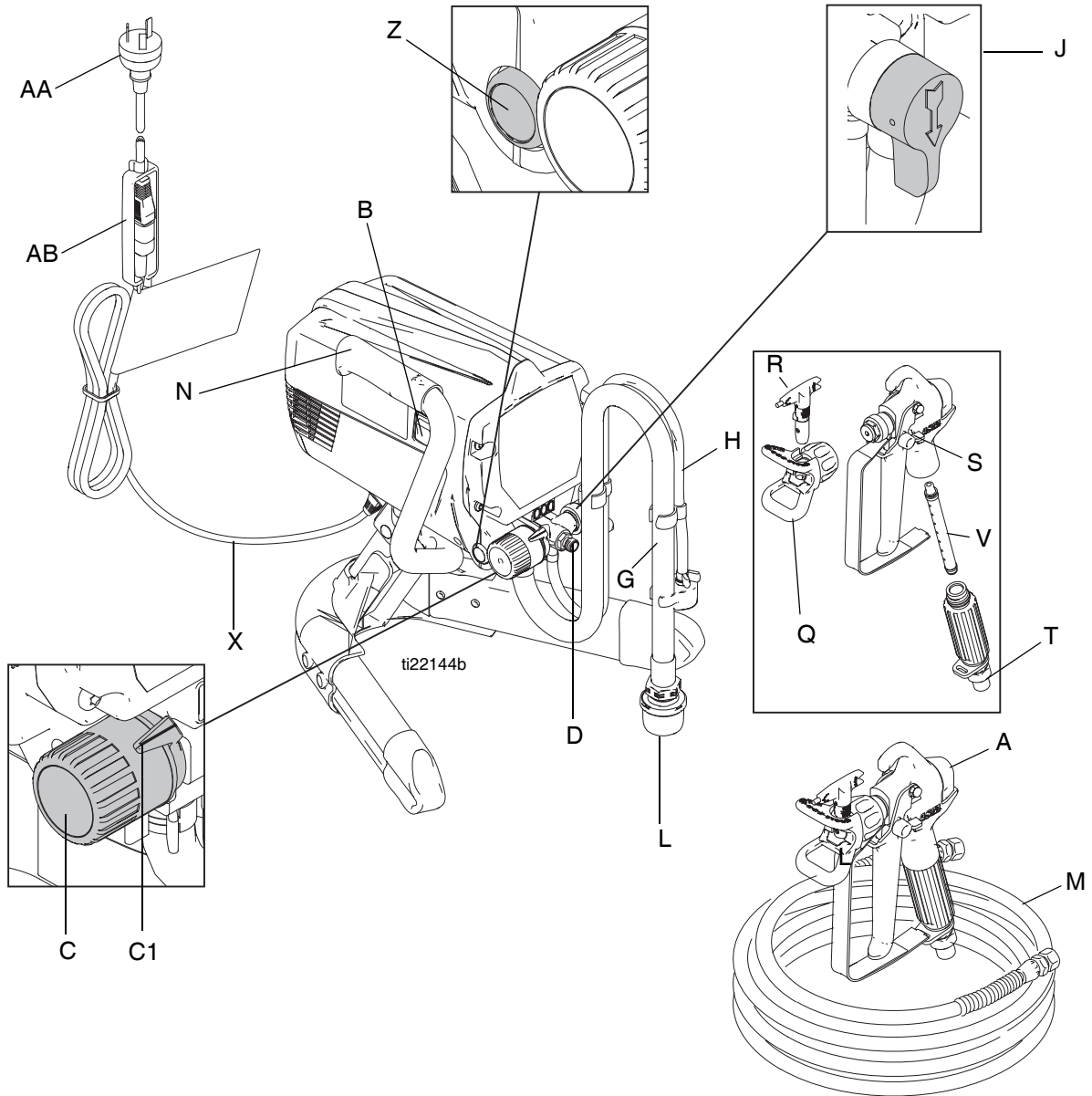

# Component Identification



# Grounding and Electric Requirements

						
--	---	---	---	--	--	--

The equipment must be grounded to reduce the risk of static sparking and electric shock. Electric or static sparking can cause fumes to ignite or explode. Improper grounding can cause electric shock. Grounding provides an escape wire for the electric current.

- The 240 VAC sprayers require a 220-240 VAC, 50/60 Hz, 10A circuit with a grounding receptacle.
- Never use an outlet that is not grounded.
- Do not use sprayer if electrical cord has damaged ground prong.
- Only use an extension cord with an undamaged 3-prong plug.

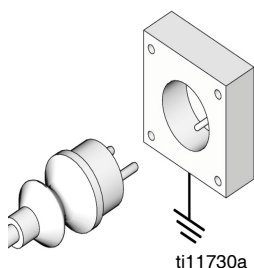

Recommended extension cords for use with this sprayer:

- 15 m (49.2 ft) 1.0 mm<sup>2</sup>
- 30 m (98.4 ft) 1.5 mm<sup>2</sup>
- 50 m (164.0 ft) 2.5 mm<sup>2</sup>

**NOTE:** Smaller gauge or longer extension cords may reduce sprayer performance.

**Spray gun:** ground through connection to a properly grounded fluid hose and pump.

**Fluid supply container:** follow local code.

**Solvent pails used when flushing:** follow local code. Use only conductive metal pails, placed on a grounded surface such as concrete. Do not place the pail on a nonconductive surface, such as paper or cardboard, which interrupts grounding continuity.

**Grounding the metal pail:** connect a ground wire to the pail by clamping one end to pail and other end to ground such as a water pipe.





ti9207a

**Maintaining grounding continuity** when flushing or relieving pressure: hold metal part of the spray gun firmly to the side of the grounded metal pail, then trigger the gun.

## Thermal Overload

Motor has a thermal overload switch to shut itself down if overheated. If unit overheats, allow approximately 45 minutes for unit to cool. Once cool, switch will close and unit will restart.

						
---	---	--	--	--	--	--

To reduce risk of injury from motor starting unexpectedly when it cools, always turn power switch OFF if motor shuts down.

# Operation

## Trigger Lock

Always engage the trigger lock when you stop spraying to prevent the gun from being triggered accidentally by hand or if dropped or bumped.

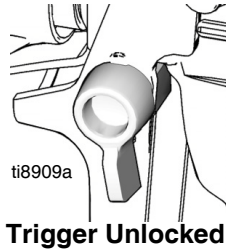
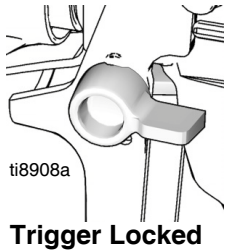

3. Turn Prime/Spray valve to PRIME position.

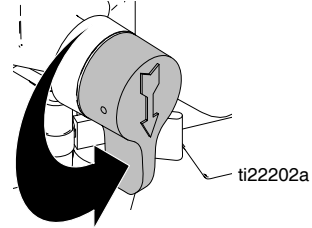

4. Disengage trigger lock. Hold gun firmly to side of pail. Trigger the gun to relieve pressure.

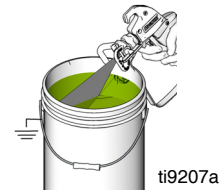

## Pressure Relief Procedure



Follow the Pressure Relief Procedure whenever you see this symbol.



This equipment stays pressurized until pressure is manually relieved. To help prevent serious injury from pressurized fluid, such as skin injection, splashing fluid and moving parts, follow the Pressure Relief Procedure when you stop spraying and before cleaning, checking, or servicing the equipment.

1. Engage trigger lock.
2. Turn power switch OFF and unplug power cord.

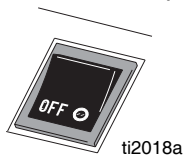

5. Engage trigger lock.

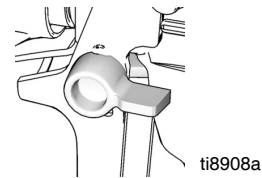

**NOTE:** Leave Prime/Spray valve in the PRIME position until you are ready to spray again.

6. If you suspect the spray tip or hose is clogged or that pressure has not been fully relieved after following the steps above, VERY SLOWLY loosen tip guard retaining nut or hose end coupling to relieve pressure gradually, then loosen completely. Clear hose or tip obstruction. Read Unclogging Spray Tip, page 16.

## Pressure Control Knob Settings

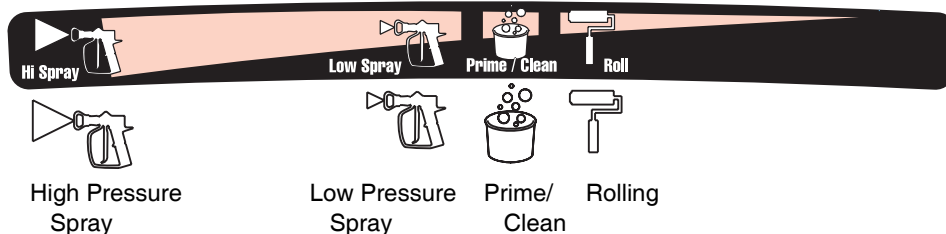

**NOTE:** To select function, align symbol on pressure control knob with setting indicator on sprayer.

# Setup

## Prime and Flush Storage Fluid

**NOTE:** This unit is not intended for lacquers.

Before you use the sprayer for the first time or begin a new spraying project, you need to prime the sprayer and flush the storage fluid out of the sprayer.

### Water-based or Oil-based (Mineral Spirit Type) Materials

- When spraying **water-based** materials, flush the system thoroughly with water.
- When spraying **oil-based** materials, flush the system thoroughly with mineral spirits or compatible, oil-based flushing solvent.
- To spray **water-based** materials **after spraying oil-based** materials, flush the system thoroughly with water first. The water flowing out of prime tube should be clear and solvent-free **before** you begin spraying the water-based material.
- To spray **oil-based** materials **after spraying water-based** materials, flush the system thoroughly with mineral spirits or a compatible oil-based flushing solvent first. The solvent flowing out of the prime tube should not contain any water.
- When flushing with solvents, ground pail and gun. Read Grounding and Electric Requirements, page 10.
- To avoid fluid splashing back on your skin or into your eyes, always aim gun at inside wall of pail.



1. Unscrew tip and guard assembly from gun.

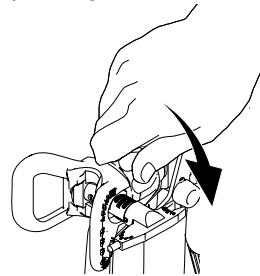

ti17267a

2. Uncoil hose and connect one end to gun. Use two wrenches to tighten securely.

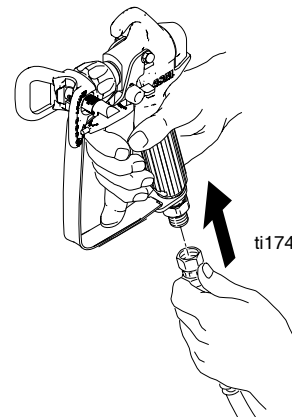

ti17494a

3. Connect other end of hose to sprayer.

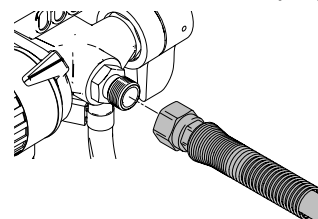

ti22204a

**NOTE:** If hose is already connected, make sure connections are tight.

4. Turn Pressure Control Knob all the way left (counter-clockwise) to minimum pressure.

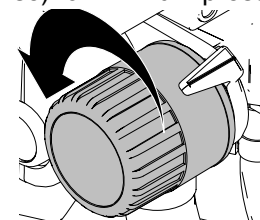

ti22206a

5. Make sure the power switch is OFF and the sprayer is unplugged.

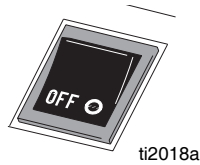

6. Separate prime tube (smaller) from suction tube (larger).

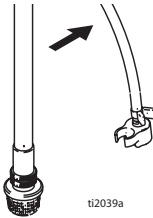

7. Place prime tube in waste pail.

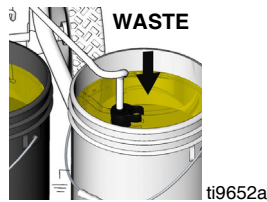

8. Submerge suction tube in water or flushing solvent.

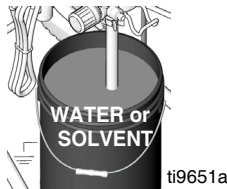

9. Move Prime/Spray Valve to PRIME.

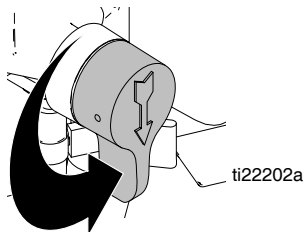

10. Plug sprayer in a grounded outlet.

11. Push pump priming button two times.

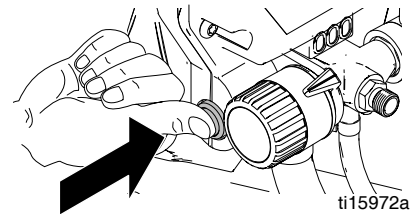

12. Turn power switch ON.

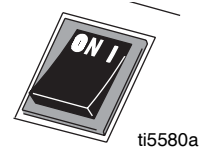

13. Align setting indicator with Prime/Clean setting on Pressure Control knob until pump starts.

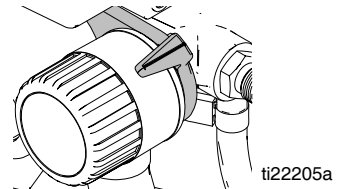

14. When sprayer starts pumping, flushing solvent and air bubbles will be purged from system. Allow fluid to flow out of prime tube, into waste pail, for 30 to 60 seconds.

15. Turn power switch OFF.

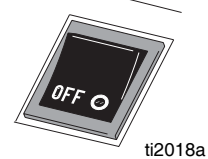

16. Transfer suction tube to paint pail and submerge suction tube in paint.

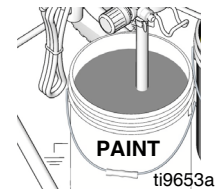

17. Turn power switch ON.

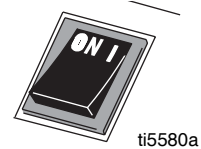

18. When you see paint coming out of prime tube:

- a. Point gun into waste pail.
- b. Unlock gun trigger lock.

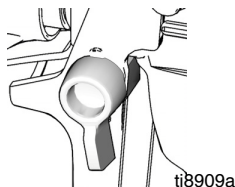

- c. Pull and hold gun trigger.
- d. Move Prime/Spray valve to SPRAY.

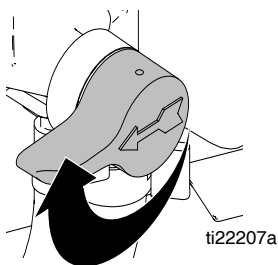

**NOTE:** Some fluids may prime faster if the Power Switch is momentarily turned off so the pump can slow and stop. Repeat several times if necessary.

19. Continue to trigger gun into waste pail until you see only paint coming out of gun.

20. Release trigger. Engage trigger lock.

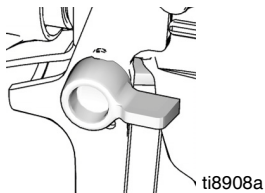

21. Transfer prime tube to paint pail and clip prime tube to suction tube.

**NOTE:** Motor stopping indicates pump and hose are primed with paint. If motor continues to run the sprayer is not properly primed. To reprime, move Prime/Spray valve to PRIME and repeat step 18.

## Install Tip and Guard on Gun

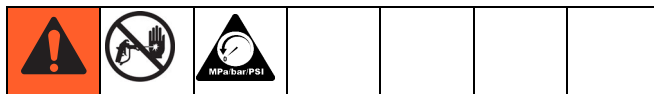

1. Relieve pressure, page 11.
2. Engage trigger lock.

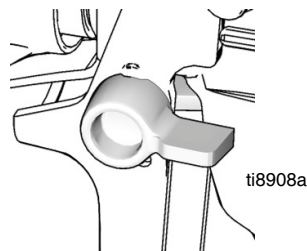

3. Verify tip and guard parts are assembled in order shown.

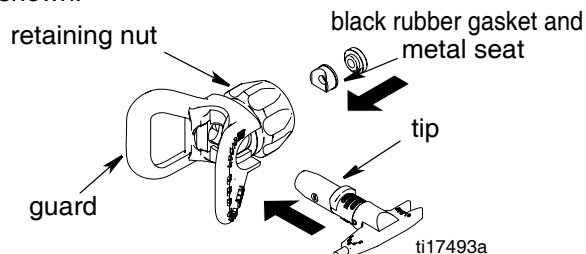

Use tip to align seat in guard

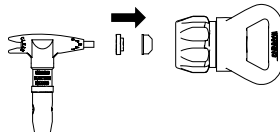

Tip must be pushed all the way into guard

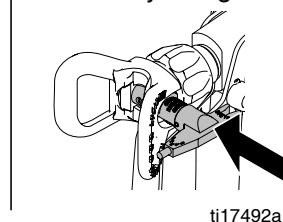

4. Screw tip and guard assembly on gun. Tighten retaining nut.

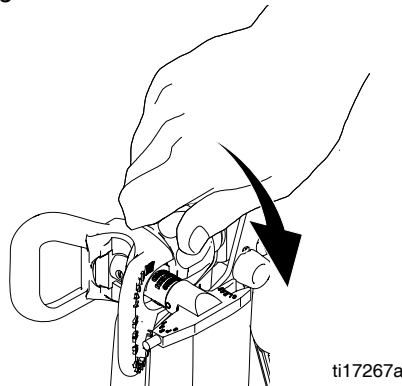

## Spraying Techniques

### Preventing Excessive Tip Wear

- Spray should be atomized (evenly distributed, no gaps at edges). Start at low pressure setting, increase pressure a little at a time until you see a good spray pattern, without tails.
- Spray at lowest pressure that atomizes paint.
- If maximum sprayer pressure is not enough for a good spray pattern, tip is too worn. See Reversible Spray Tip Selection Chart, page 17.

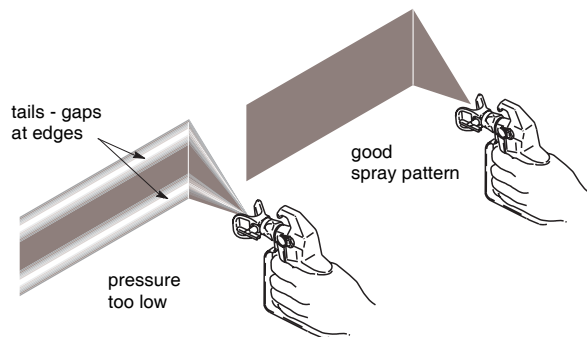

**NOTE:** If tails persist when spraying at the highest pressure, a smaller tip is needed or the material may need to be thinned.

### Adjust Spray Pressure

This sprayer is set up for most airless spraying applications. Details on tip selection, tip wear, coat thickness, etc. are provided on page 17.

**NOTE:** Motor only runs when gun is triggered. Sprayer is designed to stop pumping when gun trigger is released.

Align setting indicator with function symbol on Pressure Control knob, page 11.

- Turning knob to the right (clockwise), increases pressure at gun.
- Turning knob to the left (counter-clockwise), decreases pressure at gun.

## Getting Started



Use a piece of scrap cardboard to practice these basic spraying techniques before you begin spraying the surface.

- Hold gun 30 cm (12 in.) from surface and aim straight at surface. Tilting gun to direct spray angle causes an uneven finish.

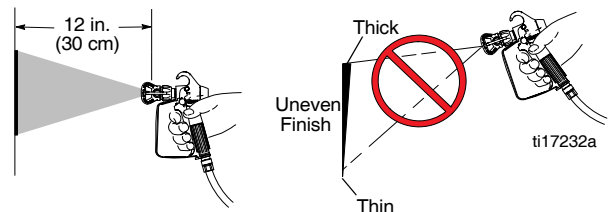

- Flex wrist to keep gun pointed straight. Fanning gun to direct spray at angle causes uneven finish.

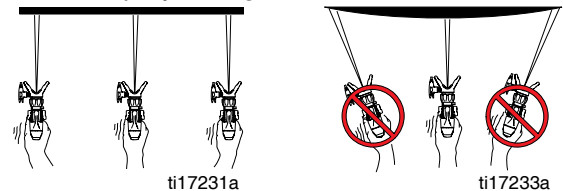

## Triggering Gun

Pull trigger after starting stroke. Release trigger before end of stroke. Gun must be moving when trigger is pulled and released.

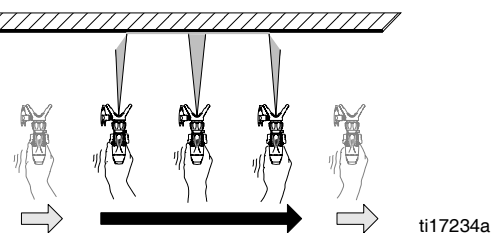

## Aiming Gun

Aim tip of gun at bottom edge of previous stroke, overlapping each stroke by half.

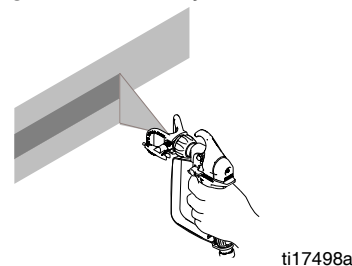



## Unclogging Spray Tip

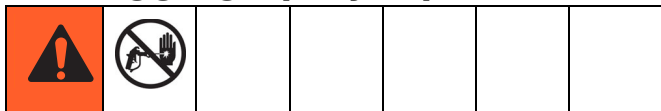

1. To UNCLOG tip obstruction, engage trigger lock.

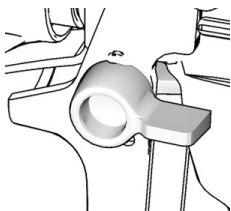

ti8908a

2. Point arrow-shaped handle backward to UNCLOG position.

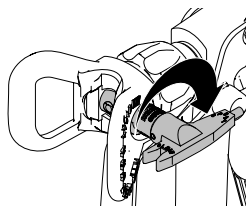

ti17491a

3. Aim gun at piece of scrap or cardboard.

4. Unlock trigger lock. Pull trigger to clear clog.

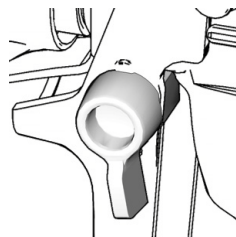

ti8909a

5. When obstruction is cleared, engage trigger lock and rotate arrow-shaped handle back to SPRAY position.

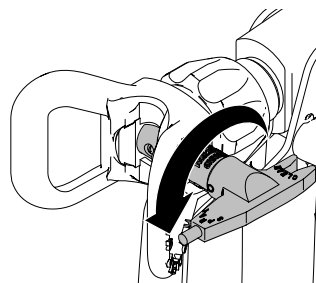

ti17490a

**NOTE:** Point the arrow-shaped handle on the spray tip forward to SPRAY and backward to UNCLOG obstructions.

## Tip Selection

### Selecting a Tip Hole Size

Tips come in a variety of hole sizes for a range of fluids. The sprayer includes the tip most likely to satisfy common spraying applications. Use the following table to determine the range of recommended tip hole sizes for each fluid type. If you need a tip other than the one supplied, see the **Uni-Tip Selection Chart** page 17.

**NOTE:** As you spray, the tip wears and enlarges. Starting with a tip hole size smaller than the maximum will allow you to spray within the rated flow capacity of the sprayer.

Tip Hole Size (expressed as diameter, based on area of elliptical orifice)	COATINGS					
	Stains	Enamels	Oil-based primers and paints	Interior latex paint	Exterior latex paint	Acrylics
0.011 in. (0.28 mm)	X	X	X			
0.013 in. (0.33 mm)	X	X	X	X		
0.015 in. (0.38 mm)		X	X	X	X	
0.017 in. (0.43 mm)			X	X	X	X



## Choosing the Correct Tip

Consider the coating and the surface to be sprayed. Make sure you use the best tip hole size for that coating and the best fan width for that surface.

### Tip Hole Size

Tip hole size controls the flow rate (the amount of paint that comes out of the gun).

#### Hints:

- Generally, use larger tip hole sizes with thicker coatings and smaller tip hole sizes with thinner coatings
- The maximum tip hole size that a sprayer can support is related to its maximum flow rate. The maximum tip hole size supported by the sprayer is 0.015 in (0.38 mm).
- Tips wear with use and need periodic replacement.

### Fan Width

Fan width is the size of the spray pattern, which determines the area covered with each stroke. For a given tip hole size, narrower fans deliver a thicker coat and wider fans deliver a thinner coat.

#### Hints:

- Select a fan width best suited for the surface being sprayed.
- Wider fans provide better coverage on broad, open surfaces.
- Narrower fans provide better control on small, confined surfaces.

## Understanding the Tip Number

The last three digits of tip number (example: 69-413) contain information about hole size and fan width on the surface when gun is held 30 cm (12 in.) from surface being sprayed.

**First digit when doubled = approximate fan width.**

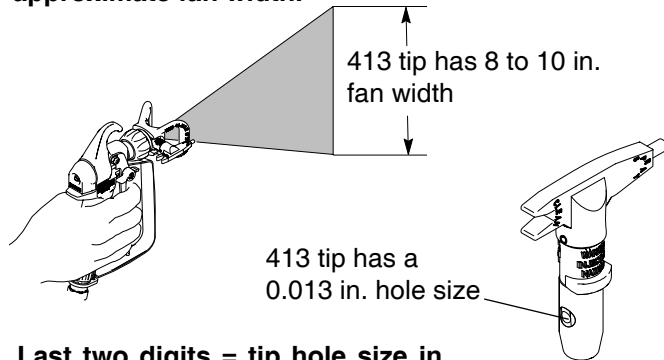

**Last two digits = tip hole size in thousands of an inch**

## Uni-Tip Selection Chart

Tip Part No.	Fan width 30 cm (12 in.) from surface	Hole Size
69-311	6 to 8 in. (152 to 203 mm)	0.011 in. (0.28 mm)
69-411	8 to 10 in. (203 to 254 mm)	0.011 in. (0.28 mm)
69-313	6 to 8 in. (152 to 203 mm)	0.013 in. (0.33 mm)
69-413	8 to 10 in. (203 to 254 mm)	0.013 in. (0.33 mm)
69-415	8 to 10 in. (203 to 254 mm)	0.015 in. (0.38 mm)
69-515	10 to 12 in. (254 to 305 mm)	0.015 in. (0.38 mm)

**Example:** For an 8 to 10 in. (203 to 254 mm) fan width and a 0.013 in. (0.33 mm) hole size, order Part No. 69-413.

# Shutdown and Cleaning

						
<ul style="list-style-type: none"> <li>To reduce the risk of static sparking, which can cause fire or explosion, always hold a metal part of the gun firmly against the metal pail when flushing. This also reduces splashing.</li> <li>To reduce risk of injection, always remove the spray tip before flushing to avoid.</li> </ul>						

## Pail Flushing

- For short term shutdown periods (overnight to two days) refer to Short Term Storage, page 21.
- For flushing after spraying oil-based coatings, use compatible oil-based flushing fluid or mineral spirits. Read Priming and Flushing Storage Fluid, page 12.
- For flushing after spraying water-based coatings, use water. Read Priming and Flushing Storage Fluid, page 12.

1. **Relieve pressure**, page 11.
2. Remove tip and guard assembly from gun and place in flushing fluid.
3. Place empty waste and water or solvent pails side by side.

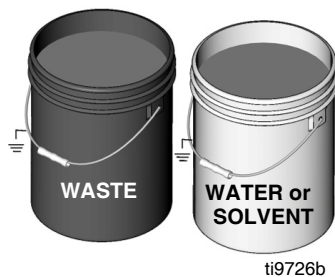

4. Lift suction tube and prime tube from paint pail. Let them drain into paint pail for a while.

5. Separate prime tube (smaller) from suction tube (larger).

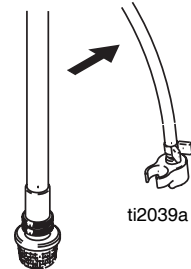

6. Place prime tube in waste pail.

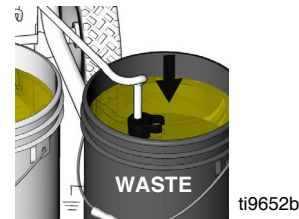

7. Submerge suction tube in water or flushing solvent.

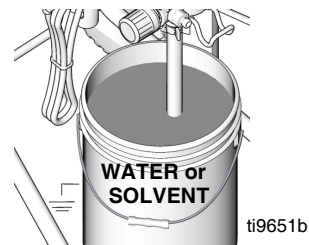

8. Turn pressure control knob to the Prime/Clean setting.

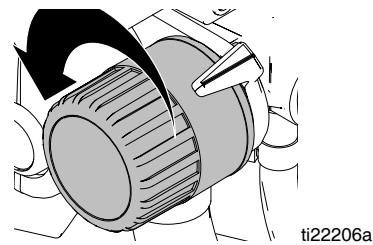

9. Turn power switch ON.

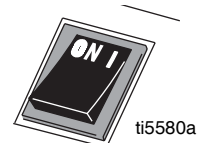

10. Flush until approximately 1/3 of the flushing fluid is emptied from the pail.

11. Turn power switch OFF.

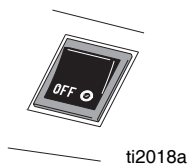

**NOTE:** Step 12 is for returning paint in hose back to paint pail. One 50-ft hose holds approximately 1-quart (1-liter) of paint.

12. To preserve paint in hose:

- a. Point gun into paint pail.
- b. Unlock gun trigger lock.

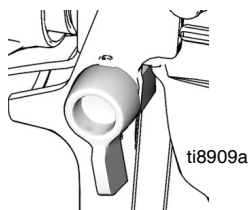

- c. Pull and hold gun trigger.
- d. Move Prime/Spray valve to SPRAY.

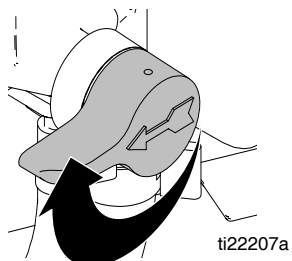

- e. Turn power switch ON.

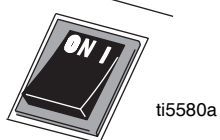

- f. Continue to hold gun trigger until you see paint diluted with flushing fluid starting to come out of gun.

13. While continuing to trigger gun, quickly move gun to redirect spray into waste pail. Continue triggering gun into waste pail until flushing fluid dispensed from gun is relatively clear.



14. Stop triggering gun. Engage the trigger lock.

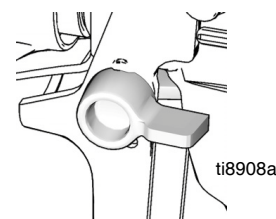

15. Turn Prime/Spray valve to PRIME.

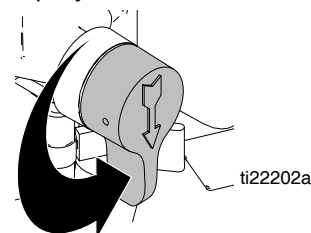

16. Turn power switch OFF.

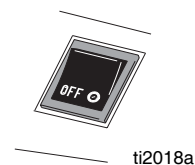

17. Fill unit with Pump Armor™ storage fluid. Read Long Term Storage, page 21.

## Cleaning Gun Filter



Perform **Pressure Relief Procedure**, page 11.

1. Engage gun trigger lock.

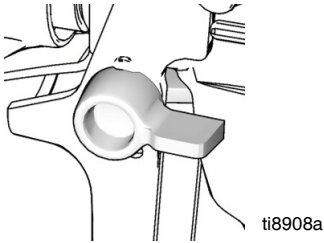

2. Unscrew hose.

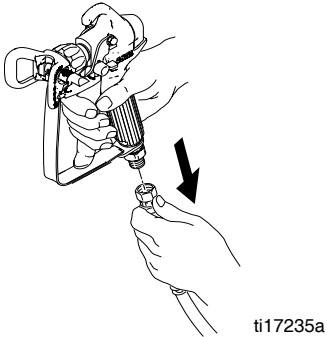

3. Remove filter and clean it in compatible solvent.

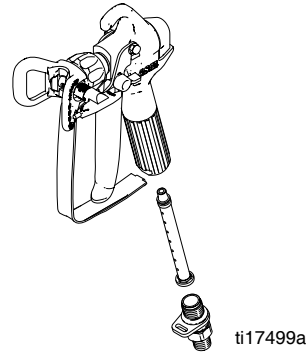

**NOTE:** Do not soak entire gun in solvent. Prolonged exposure to solvent can ruin packings.

4. Insert filter and torque to 26-32 ft-lb.

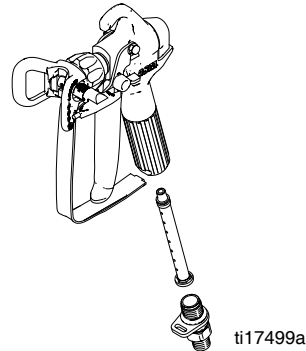

# Storage

## Short Term Storage

(up to 2 days)

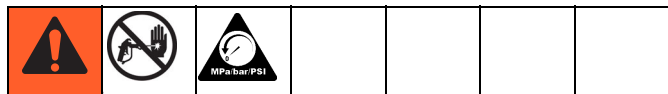

1. **Relieve pressure**, page 11.
2. Leave suction tube and prime tube in paint pail.

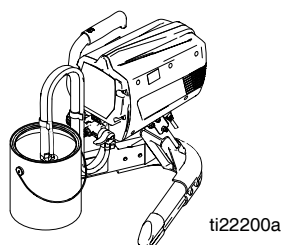

3. Cover paint pail and hoses tightly with plastic wrap.

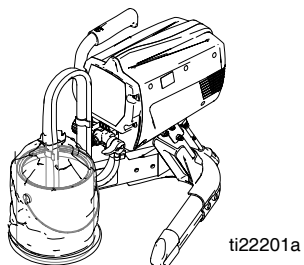

4.
  - a. Engage trigger lock.

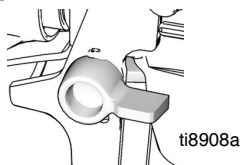

- b. Leave gun attached to hose.
- c. If you have not already cleaned them, remove tip and guard from gun and clean with water or flushing solvent. A soft brush can be used to loosen and remove dried on material if needed.

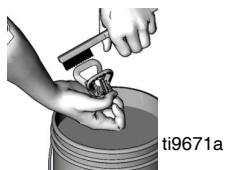

- d. Wipe paint off outside of gun using a soft cloth moistened with water or flushing solvent.

## Long Term Storage

(more than 2 days)

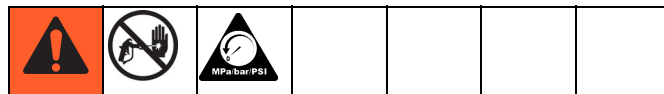

Always circulate Pump Armor storage fluid through system after cleaning. Water left in sprayer will corrode and damage pump. Follow Shutdown and Cleaning, page 18.

1. Place suction tube in Pump Armor storage fluid bottle and prime tube in waste pail.

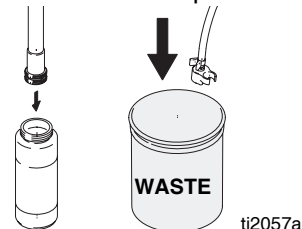

2. Move Prime/Spray valve to PRIME.

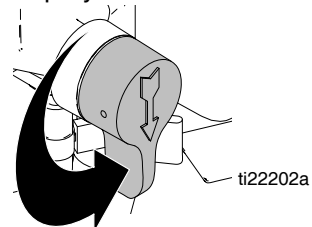

3. Turn power switch ON.

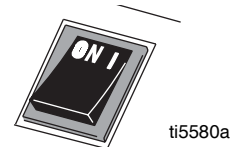

4. Turn pressure control knob clockwise until the pump turns on.

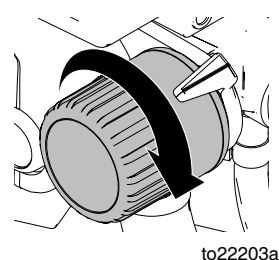

## Storage

- When storage fluid comes out of prime tube (5-10 seconds) turn power switch OFF.

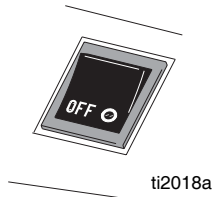

- Move Prime/Spray valve to SPRAY to keep storage fluid in sprayer during storage.

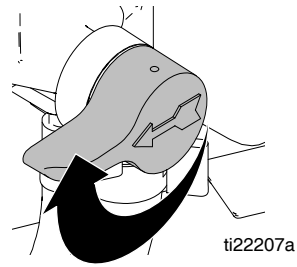

---

## Storing Sprayer

### NOTICE

- Before storing sprayer make sure all water is drained out of sprayer and hoses.
- Do not allow water to freeze in sprayer or hose.
- Do not store sprayer under pressure.

- Screw inlet screen onto suction tube.

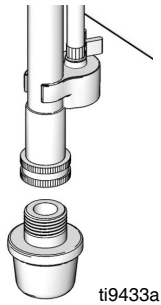

- Secure a plastic bag around suction tube to catch any drips.

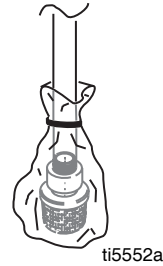

- Coil hose. Leave it connected to sprayer. Wrap hose around hose wrap bracket or sprayer stand.

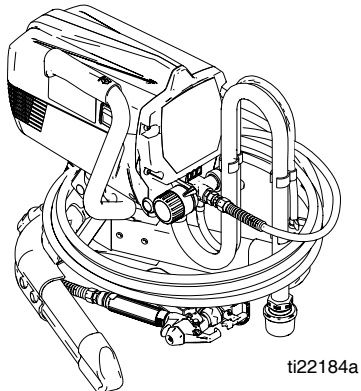

- Store sprayer indoors.

# Maintenance and Service

## NOTICE

**Protect the internal drive parts of this sprayer from water.** Openings in shroud allow cooling of mechanical parts and electronics inside. If water gets into these openings, the sprayer could malfunction or be permanently damaged.

## Caring for Sprayer

Keep sprayer and all accessories clean and in good working order.

To avoid overheating motor, keep vent holes in shroud clear for air flow. Do not cover sprayer while spraying.

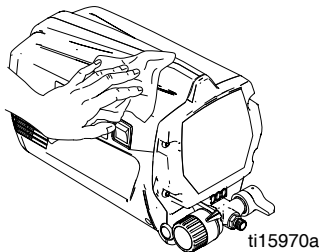

## Paint Hoses

Check hose for damage every time you spray. Do not attempt to repair hose if hose jacket or fittings are damaged. Do not use hoses shorter than 7.5 m (25 ft). Wrench tighten, using two wrenches.

## Tips

- Always clean tips with compatible solvent and brush after spraying.
- Tips may require replacement after 57 liters (15 gallons) or they may last through 227 liters (60 gallons) depending on abrasiveness of paint.
- Do not spray with worn tip.

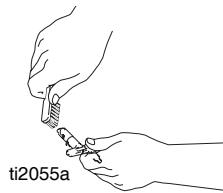

## Pump Check Valves

- Storing in water, inadequate flushing or ingested debris can cause either of the two check valves to malfunction.
- If pump does not prime after 30 seconds, try to loosen check balls by pushing pump priming button or by tapping the inlet valve with a small wrench as the sprayer is stroking.

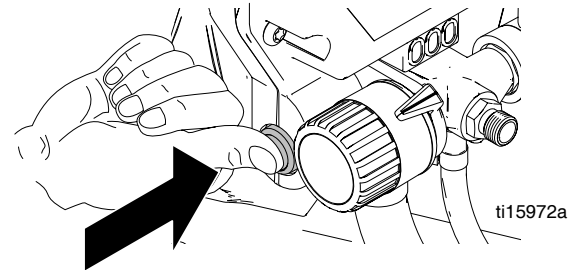

## NOTICE

Excessive shock will fracture or cause damage to pump.

**NOTE:** To verify inlet valve ball is sticking, unscrew valves from pump and check them.

If sprayer continues to cycle (motor and pump run) after you release gun trigger, pump valves may be obstructed or worn. Valve repair kits are available from Airlessco authorized service dealers.

## Pump Packings

When pump packings wear, paint will begin to leak down outside of pump.

- Replace pump packings at first sign of leaking or additional damage could occur.
- Purchase a pump repair kit and install according to instructions provided with kit.
- Consult a Graco/Airlessco authorized service center.

# Troubleshooting



Check everything in this Troubleshooting Table before you bring the sprayer to a Airlessco authorized service center.

Problem	Cause	Solution
Power switch is on and sprayer is plugged in, but motor does not run, and pump does not cycle.	Pressure is set at zero pressure.	Turn pressure control knob clockwise to increase pressure setting.
	Motor or control is damaged.	Take sprayer to Graco/Airlessco authorized service center.
	Electric outlet is not providing power.	<ul style="list-style-type: none"> <li>• Try a different outlet or plug in something that you know is working to test outlet.</li> <li>• Reset building circuit breaker or replace fuse.</li> </ul>
	Extension cord is damaged.	Replace extension cord. Read <b>Grounding and Electric Requirements</b> , page 10.
	Sprayer power cord is damaged.	Check for broken insulation or wires. Replace power cord if damaged.
	Paint and/or water is frozen or hardened in pump.	Unplug sprayer from outlet. If frozen do NOT try to start sprayer until it is completely thawed or you may damage the motor, control board and/or drivetrain.  Make sure power switch is OFF. Place sprayer in a warm area for several hours. Then plug in power cord and turn sprayer ON. Slowly increase pressure setting to see if motor will start.  If paint is hardened in sprayer, pump packings, valves, drivetrain or pressure switch may need to be replaced. Take sprayer to Graco/Airlessco authorized service center.



Problem	Cause	Solution
Pump does not prime.	Prime/Spray Valve is in SPRAY position.	Move Prime/Spray Valve to PRIME position.
	Inlet screen is clogged or suction tube is not immersed in fluid.	Clean debris off inlet screen and make sure suction tube is immersed in fluid.
	Pump was not primed with flushing fluid.	Remove suction tube from paint. Prime pump with water or solvent-based flushing fluid, page 12.
	Inlet valve check ball is stuck.	Remove suction tube and place a pencil into the inlet section to dislodge the ball, or press pump priming button.
	Inlet valve check ball or seat is dirty	Remove inlet fitting. Clean or replace ball and seat.
	Outlet valve check ball is stuck.	Remove outlet fitting and clean outlet check ball.
	Suction tube is leaking.	Tighten suction tube connection. Inspect for cracks or vacuum leaks.
	Pump does not prime with fluid.	Remove suction tube from paint. Prime pump with water or solvent-based flushing fluid.
	Fluids are viscous or sticky.	Some fluids may prime faster if the Power Switch is momentarily turned off so the pump can slow and stop. Repeat several times if necessary.
Pump cycles but does not build up pressure.	Pump is not primed.	Prime pump.
	Inlet screen is clogged.	Clean debris off inlet screen and make sure suction tube is immersed in fluid.
	Suction tube is not immersed in paint.	Make sure suction tube is immersed in paint.
	Suction tube is leaking.	Tighten suction tube connection. Inspect for cracks or vacuum leaks. If cracked or damaged, replace suction tube.
	Prime/Spray Valve is worn or obstructed with debris.	Take sprayer to Graco/Airlessco authorized service center.
	Pump check ball is stuck.	Read <b>Pump does not prime</b> section in Troubleshooting, page 25

Problem	Cause	Solution
Pump cycles, but paint only dribbles or spurts when spray gun is triggered.	Pressure is set too low.	Slowly turn Pressure Control Knob clockwise to increase pressure setting which will turn motor on to build pressure.
	Spray tip is clogged.	Unclog spray tip, page 16.
	Spray gun fluid filter is clogged.	Clean or replace gun fluid filter, page 20.
	Spray tip is too large or worn.	Replace tip.
Pressure is set at maximum but cannot achieve a good spray pattern.	Reversible spray tip is in UNCLOG position.	Rotate arrow-shaped handle on spray tip so it points forward in SPRAY position, page 16.
	Spray tip is too large for sprayer.	Select smaller spray tip.
	Spray tip is worn beyond capability of sprayer.	Replace spray tip.
	Extension cord is too long or not heavy enough gauge.	Replace extension cord. Grounding and Electrical Requirements, page 10.
	Spray gun fluid filter is clogged.	Clean or replace spray gun fluid filter, page 20.
	Inlet screen is clogged.	Clean debris off inlet screen.
	Pump valves are worn, or debris is clogging valve.	Check for worn pump valves. <ul style="list-style-type: none"> <li>a. Prime sprayer with paint</li> <li>b. Trigger gun momentarily. When trigger is released, pump should cycle momentarily and stop. If pump continues to cycle, pump valves may be worn.</li> <li>c. Remove valves and check for debris.</li> </ul>
	Material is too thick.	Thin material.
Hose is too long (if extra section is added).	Remove section of hose.	
Spray gun stopped spraying.	Suction tube is leaking.	Tighten suction tube connection. Inspect for cracks or vacuum leaks.
	Spray tip is clogged.	Unclog spray tip, page 16.
When paint is sprayed, it runs down the wall or sags.	Coat is going on too thick.	Move gun faster.
	Coat is going on too thick.	Choose a tip with smaller hole size.
	Coat is going on too thick.	Choose tip with wider fan.
	Coat is going on too thick.	Make sure gun is far enough from surface.

Problem	Cause	Solution
When paint is sprayed, coverage is inadequate.	Coat is going on too thin.	Move gun slower.
		Choose tip with larger hole size.
		Choose tip with narrower fan.
		Make sure gun is close enough to surface.
Fan pattern varies dramatically while spraying.  OR  Sprayer does not turn on promptly when resuming spraying.	Pressure control switch is worn and causing excessive pressure variation.	Take sprayer to Graco/Airlessco authorized service center.
Cannot trigger spray gun.	Spray gun trigger lock is locked.	Rotate trigger safety lever to unlock trigger lock, page 11.
Paint is coming out of pressure control switch.	Pressure control switch is worn.	Take sprayer to Graco/Airlessco authorized service center.
Prime/Spray valve actuates automatically relieving pressure through prime tube.	System is over pressurizing.	Take sprayer to Graco/Airlessco authorized service center.
Paint leaks down outside of pump.	Pump packings are worn.	Replace pump packings.
Motor is hot and runs intermittently. Motor automatically shuts off due to excessive heat. Damage can occur if cause is not corrected.  See <b>Thermal Overload</b> , page 10.	Vent holes in enclosure are plugged or sprayer is covered.	Keep vent holes clear of obstructions and over spray and keep sprayer open to air.
	Extension cord is too long or not a heavy enough gauge.	Replace extension cord. Read <b>Grounding and Electrical Requirements</b> , page 10.
	Unregulated electrical generator being used has excessive voltage.	Use electrical generator with a proper voltage regulator. Sprayer requires 220-240 VAC, 50/60 Hz.

# Parts

## SP200 240V Model 24U967 Series A

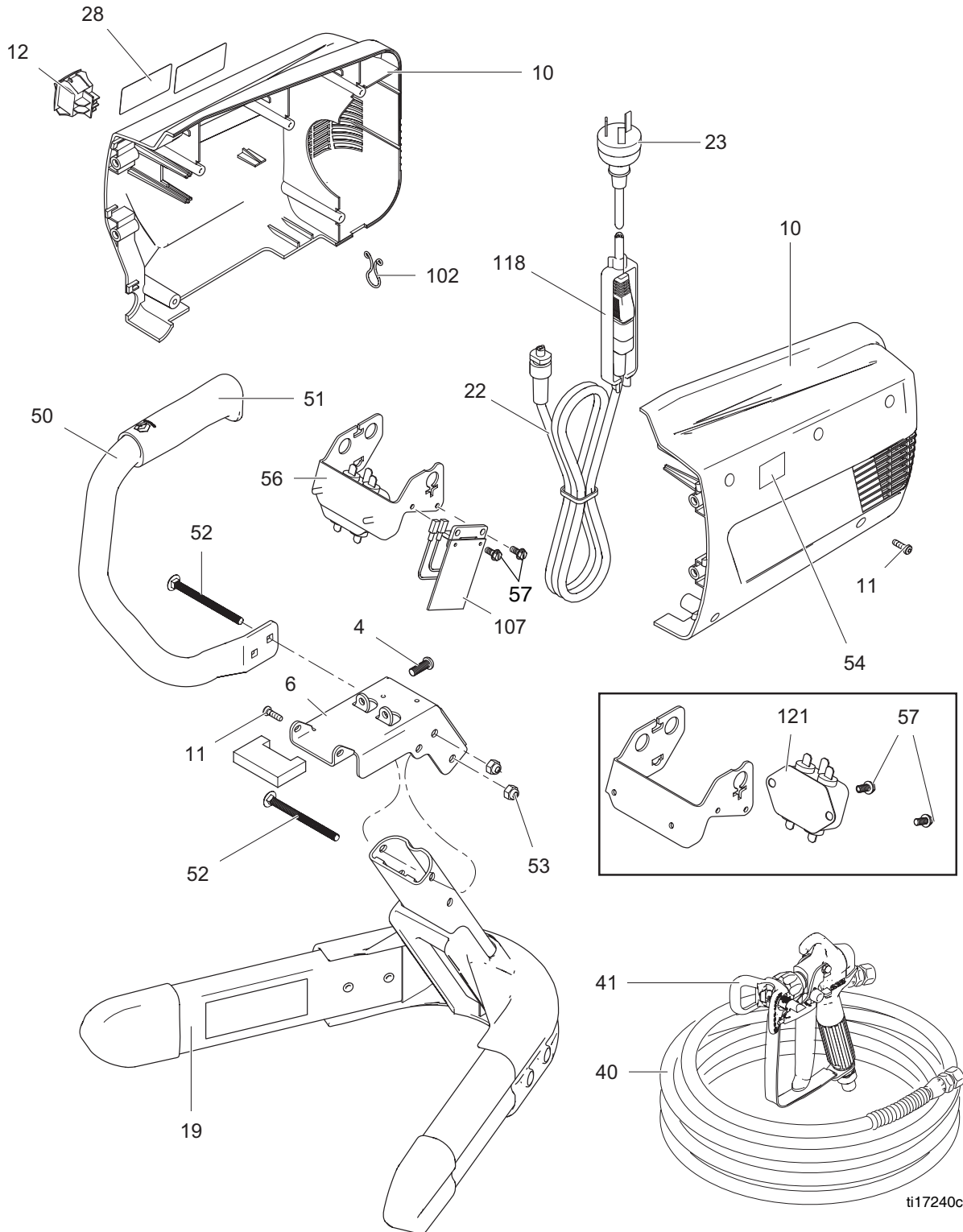

## Parts List

### SP200 240V Model 24U967 Series A

Ref.	Part	Description	Qty.	Ref.	Part	Description	Qty.
4	112689	SCREW	4	52	122233	BOLT, carriage	3
6	16D684	FRAME	1	53	102040	NUT, lock, hex	3
10	16X022	ENCLOSURE, sprayer, black (includes 11, 17, 28, 54)	1	54	16D576	LABEL, Made in USA	1
11	115477	SCREW, mach, torx pan hd	6	56	16W317	BRACKET, control board/EMI filter (Includes 121 and 57 qty. 2)	1
12	118899	SWITCH, rocker, spdt	1	57	115492	SCREW, mach, slot hex wash hd	4
19	16E839	BASE, assembly (includes 52 qty. 2, 53 qty. 2)	1	102	121423	RETAINER, wire	1
22	16X876	CORD SET, (includes 23, 118)	1	107	16G223	KIT, control board (includes 57 qty. 2)	1
23	242005	CORD SET, adapter, Australia	1	115▲	16T398	LABEL, warning ENG/CHI/KOR	1
28▲	195792	LABEL, warning	1	118	195551	RETAINER, adapter, cord	1
40	245449	HOSE, cpld, 1/4 in. x 25 ft	1	121	16W227	FILTER, EMI	1
41	288681	GUN, 500, 4-finger, ASM	1				
47▲	179960	SIGN, warning (not shown)	1				
50	256992	HANDLE, painted	1				
51	116139	GRIP, handle	1				

▲ Replacement Danger and Warning labels, tags, and cards are available at no cost.



## Parts List

### SP200 240V Model 24U967 Series A

Ref.	Part	Description	Qty.	Ref.	Part	Description	Qty.
1	16G227	PUMP, assembly, 240V (includes 1a, 1b, 1c, 1d, 1e, 1f, 1g, 72)	1	30	197607	TUBE, suction set	1
1a	235014	DUMP VALVE	1	31	16F635	LABEL, control	1
1b	24E578	BASE, valve	1	36	195400	CLIP, spring	2
1c	111600	PIN, grooved	1	37	195697	STRAINER	1
1d	187625	HANDLE, valve, drain	1	38	244035	DEFLECTOR, barbed	1
1e	16F292	VALVE, outlet	1	55	16W319	COVER, gear	1
1f	16F621	MODULE, ball knocker	1	66	115489	CLAMP, drain tube	2
1g	15Y291	PISTON	1	67	195084	TUBE, drain	1
2	16E778	HOUSING, drive (includes 4)	1	70	116295	CLAMP, tube	1
4	112689	SCREW, button hd	4	72	16F291	HOUSING, inlet valve (includes 72a, 72b, 72c)	1
5	16G228	MOTOR, 230V	1	72a	124249	BALL	1
7	15Y296	COVER, wire	1	72b	103338	PACKING, o-ring	1
8	15A464	LABEL, control	1	72c	123849	SPRING, compression	1
9	115498	SCREW, mach, slot hex wash hd	1	73	246286	KIT, control, pressure (includes 8)	1
16	16F629	COVER, housing	1	74	16F047	KIT, repair, pump (includes 1e, 1g, 4, 72)	1
17	120724	SCREW	4				
18	16F554	LABEL, brand, SP200	1				

# Technical Data

	US	Metric	
Working pressure range	0-3000 psi	0-207 BAR, 0-21 Mpa	
Electric Motor	4.5A (open frame, universal)		
Operating horsepower	1/2		
Maximum delivery (with tip)	0.27 gpm	1.02 lpm	
Paint hose	1/4 in. x 25 ft	6.4mm X 7.5 m	
Maximum tip hole size	0.015 in	0.38 mm	
Weight, Sprayer only	13.3 lb	6.0 kg	
Weight, sprayer, hose, & gun	16.5 lb	7.5 kg	
Dimensions (Upright):			
	Length	13.7 in	34.8 cm
	Width	16.2 in	41.1 cm
	Height	18.2 in	46.3 cm
Power cord	1.0 mm <sup>2</sup> , 3-wire, 1.8 m (6 ft)		
Fluid inlet fitting	1/4 npsm external thread		
Fluid outlet fitting	3/4 in. internally threaded (standard garden hose)		
Inlet screen (on suction tube)	1190 micron (16 mesh)		
Wetted parts, pump and hose	stainless steel, zinc plated carbon steel, brass, ultra-high molecular weight polyethylene (UHMWPE), Carbide, Nylon, Aluminum, PVC, polypropylene, fluoroelastomer		
Wetted parts, gun	aluminum, brass, carbide, nylon, ultra-high molecular weight polyethylene (UHMWPE), zinc		
Generator requirement	1500 Watt minimum		
Electrical power requirement	220-240V AC 50/60 Hz, 1 phase, 10A		
Storage temperature range◆❖	-30° to 160° F	-35° to 71° C	
Operating temperature range✓	40° to 115° F	4° to 46° C	

- ◆ When pump is stored with non-freezing fluid. Pump damage will occur if water or latex paint freezes in pump.
- ❖ Damage to plastic parts may result if impact occurs in low temperature conditions.
- ✓ Changes in paint viscosity at very low or very high temperatures can affect sprayer performance.





# Airlessco Standard Warranty

Airlessco warrants all equipment referenced in this document which is manufactured by Airlessco and bearing its name to be free from defects in material and workmanship on the date of sale to the original purchaser for use. With the exception of any special, extended, or limited warranty published by Airlessco, Airlessco will, for a period of twelve months from the date of sale, repair or replace any part of the equipment determined by Airlessco to be defective. This warranty applies only when the equipment is installed, operated and maintained in accordance with Airlessco's written recommendations.

This warranty does not cover, and Airlessco shall not be liable for general wear and tear, or any malfunction, damage or wear caused by faulty installation, misapplication, abrasion, corrosion, inadequate or improper maintenance, negligence, accident, tampering, or substitution of non-Airlessco component parts. Nor shall Airlessco be liable for malfunction, damage or wear caused by the incompatibility of Airlessco equipment with structures, accessories, equipment or materials not supplied by Airlessco, or the improper design, manufacture, installation, operation or maintenance of structures, accessories, equipment or materials not supplied by Airlessco.

This warranty is conditioned upon the prepaid return of the equipment claimed to be defective to an authorized Airlessco distributor for verification of the claimed defect. If the claimed defect is verified, Airlessco will repair or replace free of charge any defective parts. The equipment will be returned to the original purchaser transportation prepaid. If inspection of the equipment does not disclose any defect in material or workmanship, repairs will be made at a reasonable charge, which charges may include the costs of parts, labor, and transportation.

**THIS WARRANTY IS EXCLUSIVE, AND IS IN LIEU OF ANY OTHER WARRANTIES, EXPRESS OR IMPLIED, INCLUDING BUT NOT LIMITED TO WARRANTY OF MERCHANTABILITY OR WARRANTY OF FITNESS FOR A PARTICULAR PURPOSE.**

Airlessco's sole obligation and buyer's sole remedy for any breach of warranty shall be as set forth above. The buyer agrees that no other remedy (including, but not limited to, incidental or consequential damages for lost profits, lost sales, injury to person or property, or any other incidental or consequential loss) shall be available. Any action for breach of warranty must be brought within two (2) years of the date of sale.

**AIRLESSCO MAKES NO WARRANTY, AND DISCLAIMS ALL IMPLIED WARRANTIES OF MERCHANTABILITY AND FITNESS FOR A PARTICULAR PURPOSE, IN CONNECTION WITH ACCESSORIES, EQUIPMENT, MATERIALS OR COMPONENTS SOLD BUT NOT MANUFACTURED BY Airlessco.** These items sold, but not manufactured by Airlessco (such as electric motors, switches, hose, etc.), are subject to the warranty, if any, of their manufacturer. Airlessco will provide purchaser with reasonable assistance in making any claim for breach of these warranties.

In no event will Airlessco be liable for indirect, incidental, special or consequential damages resulting from Airlessco supplying equipment hereunder, or the furnishing, performance, or use of any products or other goods sold hereto, whether due to a breach of contract, breach of warranty, the negligence of Airlessco, or otherwise.

## **FOR AIRLESSCO CANADA CUSTOMERS**

The Parties acknowledge that they have required that the present document, as well as all documents, notices and legal proceedings entered into, given or instituted pursuant hereto or relating directly or indirectly hereto, be drawn up in English. Les parties reconnaissent avoir convenu que la rédaction du présente document sera en Anglais, ainsi que tous documents, avis et procédures judiciaires exécutés, donnés ou intentés, à la suite de ou en rapport, directement ou indirectement, avec les procédures concernées.

**TO PLACE AN ORDER OR FOR SERVICE**, contact your Airlessco distributor,  
or call 1-800-223-8213 to identify the nearest distributor.

*All written and visual data contained in this document reflects the latest product information available at the time of publication.  
Airlessco reserves the right to make changes at any time without notice.*

Original Instructions. This manual contains English. MM 333089

**AIRLESSCO • 3501 N. 4th AVENUE • SIOUX FALLS, SD 57104 • USA**

**Copyright 2014, Airlessco. All Airlessco manufacturing locations are registered to ISO 9001.**

Revision A - 2014