

E-Flo UniDrumTM Supply System

3A8735A

EN

Bulk Supply System for 300 Gallon (1200 Liter) Magnadrums or 1000 Liter totes. For professional use only.

Not approved for use in explosive atmospheres or hazardous (classified) locations.

The E-Flo UniDrum Supply System is composed of either one (single) or two (tandem) Supply Units. The E-Flo UniDrum Supply System evacuates 300 gallon (1200 liter) magnadrums, 1000 liter totes, or other tote drums of the same size and capacity. The E-Flo UniDrum Supply System pumps and transfers flowable and highly viscous materials such as sealant, adhesives, and sound deadeners from bulk drums.

See page 4 for model information.



Important Safety Instructions

Read all warnings and instructions in this manual and related manuals before using the equipment. Save these instructions.

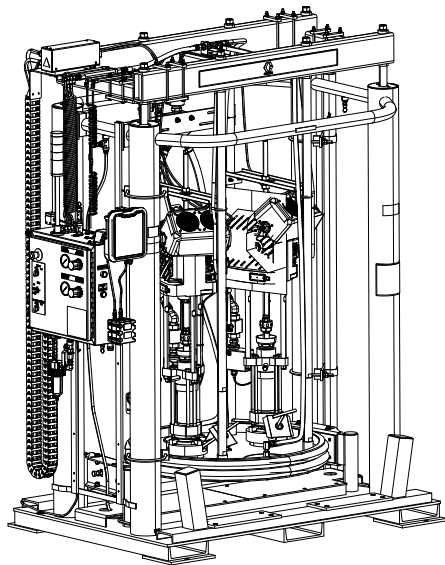

E-Flo UniDrum Left Hand Supply Unit

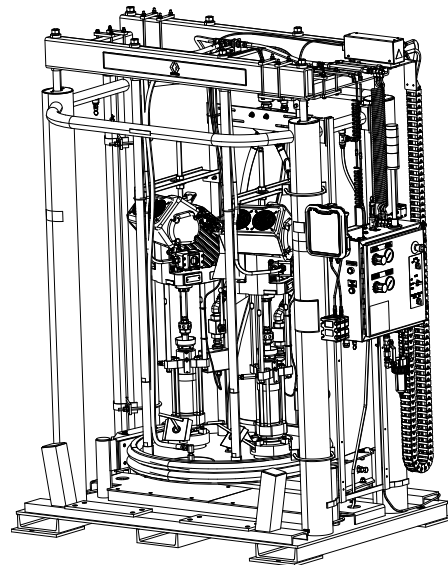

E-Flo UniDrum Right Hand Supply Unit

Contents

Related Manuals	3	Operation	34
Models	4	ADM Run Screens	34
1000 Liter Units	4	Setup Screens	38
300 Gallon Units	5	Changing Empty Drums	42
Warnings	6	Priming	43
Uncrating the System	9	Running the System	45
Overview	9	Stopping the System	45
Installation Overview	9	Light Tower Color Codes	45
Operation Overview	9	Pressure Relief Procedures	46
Component Identification	11	Fluid Pressure Relief Procedure	46
1000 Liter Units	11	Pneumatic Pressure Relief Procedure	47
300 Gallon Units	12	Maintenance	48
Control Box	13	Preventative Maintenance Schedule	48
General Description	16	Flushing the System	48
Advanced Display Module (ADM)	17	Cleaning the System	48
Advanced Display Module (ADM)	17	Wiper Lubrication	49
ADM Component Identification	18	Ram Assembly Service	50
ADM LED Status Descriptions	18	Piston Rod Seal Service	50
ADM Display Details	19	Ram Piston Service	51
ADM Icons	21	Depressurization Valve (Ball Seat Applicator) Repair Procedure	52
ADM Soft Keys	22	Servicing the Pumps	52
Installation	23	Replacing Wipers	52
Preparing the Site	23	Pump Removal	54
Selecting a Location for the UniDrum	23	Recycling and Disposal	55
Preparing to Install the UniDrum	23	End of Product Life	55
Installing the UniDrum	24	Troubleshooting	56
ADM and Light Tower Kit, 26D425	24	Ram Assembly Troubleshooting	56
Communication Gateway Module (CGM) Kits	25	Pump Troubleshooting	57
Tandem Cable Kit, 26B339	27	Software Troubleshooting	58
Grounding	27	Error Codes and Troubleshooting	58
Connecting Power to the Control Box	28	Errors	58
Connecting the Air Supply Lines to the UniDrum	29	Events Log Screen	58
Connecting Output Hose to the Pumps	30	Errors Log Screen	59
Flushing the System Before Initial Use	31	Troubleshooting Screen	59
Adjusting the Drum Lid Holder Before Initial Use - 300 Gallon Systems	31	Troubleshoot Errors	59
Initial System Startup Procedure	32	Troubleshoot Error Codes	60
Drum Settings	33		

USB Data	69
Download Procedure	69
USB Logs	69
Event Log	69
Unit X - Pump X Log	70
Cycles Log	70
System Configuration Settings	70
Custom Language File	70
Create Custom Language Strings	71
Upload Procedure	71
Communications Gateway Module (CGM)	72
Overview	72
Connection Details	72
E-Flo UniDrum and PLC Connection Setup	74
Available Internal Data	75
Time and Date Information	83
Timing Diagrams	84
Error Code Handling	90
Active Alarm Descriptions	91
(Data Exchange Command Value = 0 or 3)	91
Active Deviation Descriptions	92
(Data Exchange Command Value = 1 or 4)	92
Active Advisory Descriptions	92
(Data Exchange Command Value = 2 or 5)	92
Setup	93
Electrical Diagrams	96
Control Box	96
Pneumatic Diagram	101
Control Box	101
Dimensions	102
300 Gallon Units	102
1000 Liter Units	103
Technical Specifications	105
California Proposition 65	105
Graco Standard Warranty	106

Related Manuals

Manual in English	Description
3A8736	E-Flo UniDrum Supply System Repair-Parts
3A6482	APD20 Advanced Precision Driver Instructions
3A6586	E-Flo SP Electric Pumps for Sealants and Adhesives Installation-Parts
3A6321	ADM Token In-System Programming Instructions
3A1244	Graco control Architecture Module Programming
3A1906	Light Tower Kit Instructions-Parts
311825	Dura-Flo® Lowers Instructions-Parts
311827	Dura-Flo™ Lowers Repair-Parts

Models

The E-Flo UniDrum Supply Units listed below are covered in this manual. For specific pump information, refer to the chart in **Servicing the Pumps** on page 52.

1000 Liter Units



Left Side Mounted Control Box					Right Side Mounted Control Box				
Carbon Steel									
Supply Unit Part No.	Pump Size	Pump Type	Voltage	Max Fluid Working Pressure	Supply Unit Part No.	Pump Size	Pump Type	Voltage	Max Fluid Working Pressure
26D395	290cc	CS/Severe Duty	230V	2800 psi (193 bar, 19.3 MPa)	26D407	290cc	CS/Severe Duty	230V	2800 psi (193 bar, 19.3 MPa)
26D396	290cc	CS/Severe Duty	400V/ Y	2800 psi (193 bar, 19.3 MPa)	26D408	290cc	CS/Severe Duty	400V/ Y	2800 psi (193 bar, 19.3 MPa)
26D397	290cc	CS/Severe Duty	480V	2800 psi (193 bar, 19.3 MPa)	26D409	290cc	CS/Severe Duty	480V	2800 psi (193 bar, 19.3 MPa)
26D392	430cc	CS/Severe Duty	230V	1900 psi (131 bar, 13.1 MPa)	26D404	430cc	CS/Severe Duty	230V	1900 psi (131 bar, 13.1 MPa)
26D393	430cc	CS/Severe Duty	400V/ Y	1900 psi (131 bar, 13.1 MPa)	26D405	430cc	CS/Severe Duty	400V/ Y	1900 psi (131 bar, 13.1 MPa)
26D394	430cc	CS/Severe Duty	480V	1900 psi (131 bar, 13.1 MPa)	26D406	430cc	CS/Severe Duty	480V	1900 psi (131 bar, 13.1 MPa)
26D398	430cc	SS/ MaxLife	230V	1900 psi (131 bar, 13.1 MPa)	26D410	430cc	SS/ MaxLife	230V	1900 psi (131 bar, 13.1 MPa)
26D399	430cc	SS/ MaxLife	400V/ Y	1900 psi (131 bar, 13.1 MPa)	26D411	430cc	SS/ MaxLife	400V/ Y	1900 psi (131 bar, 13.1 MPa)
26D400	430cc	SS/ MaxLife	480V	1900 psi (131 bar, 13.1 MPa)	26D412	430cc	SS/ MaxLife	480V	1900 psi (131 bar, 13.1 MPa)
Stainless Steel									
Supply Unit Part No.	Pump Size	Pump Type	Voltage	Max Fluid Working Pressure	Supply Unit Part No.	Pump Size	Pump Type	Voltage	Max Fluid Working Pressure
26D401	430cc	SS/ MaxLife	230V	1900 psi (131 bar, 13.1 MPa)	26D413	430cc	SS/ MaxLife	230V	1900 psi (131 bar, 13.1 MPa)
26D402	430cc	SS/ MaxLife	400V/ Y	1900 psi (131 bar, 13.1 MPa)	26D414	430cc	SS/ MaxLife	400V/ Y	1900 psi (131 bar, 13.1 MPa)
26D403	430cc	SS/ MaxLife	480V	1900 psi (131 bar, 13.1 MPa)	26D415	430cc	SS/ MaxLife	480V	1900 psi (131 bar, 13.1 MPa)





300 Gallon Units

Left Side Mounted Control Box					Right Side Mounted Control Box				
Carbon Steel									
Supply Unit Part No.	Pump Size	Pump Type	Voltage	Max Fluid Working Pressure	Supply Unit Part No.	Pump Size	Pump Type	Voltage	Max Fluid Working Pressure
26D371	290cc	CS/Severe Duty	230V	2800 psi (193 bar, 19.3 MPa)	26D383	290cc	CS/Severe Duty	230V	2800 psi (193 bar, 19.3 MPa)
26D372	290cc	CS/Severe Duty	400V/ Y	2800 psi (193 bar, 19.3 MPa)	26D384	290cc	CS/Severe Duty	400V/ Y	2800 psi (193 bar, 19.3 MPa)
26D373	290cc	CS/Severe Duty	480V	2800 psi (193 bar, 19.3 MPa)	26D385	290cc	CS/Severe Duty	480V	2800 psi (193 bar, 19.3 MPa)
26D368	430cc	CS/Severe Duty	230V	1900 psi (131 bar, 13.1 MPa)	26D380	430cc	CS/Severe Duty	230V	1900 psi (131 bar, 13.1 MPa)
26D369	430cc	CS/Severe Duty	400V/ Y	1900 psi (131 bar, 13.1 MPa)	26D381	430cc	CS/Severe Duty	400V/ Y	1900 psi (131 bar, 13.1 MPa)
26D370	430cc	CS/Severe Duty	480V	1900 psi (131 bar, 13.1 MPa)	26D382	430cc	CS/Severe Duty	480V	1900 psi (131 bar, 13.1 MPa)
26D374	430cc	SS/ MaxLife	230V	1900 psi (131 bar, 13.1 MPa)	26D386	430cc	SS/ MaxLife	230V	1900 psi (131 bar, 13.1 MPa)
26D375	430cc	SS/ MaxLife	400V/ Y	1900 psi (131 bar, 13.1 MPa)	26D387	430cc	SS/ MaxLife	400V/ Y	1900 psi (131 bar, 13.1 MPa)
26D376	430cc	SS/ MaxLife	480V	1900 psi (131 bar, 13.1 MPa)	26D388	430cc	SS/ MaxLife	480V	1900 psi (131 bar, 13.1 MPa)
Stainless Steel									
Supply Unit Part No.	Pump Size	Pump Type	Voltage	Max Fluid Working Pressure	Supply Unit Part No.	Pump Size	Pump Type	Voltage	Max Fluid Working Pressure
26D377	430cc	SS/ MaxLife	230V	1900 psi (131 bar, 13.1 MPa)	26D389	430cc	SS/ MaxLife	230V	1900 psi (131 bar, 13.1 MPa)
26D378	430cc	SS/ MaxLife	400V/ Y	1900 psi (131 bar, 13.1 MPa)	26D390	430cc	SS/ MaxLife	400V/ Y	1900 psi (131 bar, 13.1 MPa)
26D379	430cc	SS/ MaxLife	480V	1900 psi (131 bar, 13.1 MPa)	26D391	430cc	SS/ MaxLife	480V	1900 psi (131 bar, 13.1 MPa)

Warnings

The following warnings are for the setup, use, grounding, maintenance, and repair of this equipment. The exclamation point symbol alerts you to a general warning and the hazard symbols refer to procedure-specific risks. When these symbols appear in the body of this manual or on warning labels, refer back to these Warnings. Product-specific hazard symbols and warnings not covered in this section may appear throughout the body of this manual where applicable.

 DANGER	
 	<p>SEVERE ELECTRIC SHOCK HAZARD</p> <p>This equipment can be powered by more than 240 V. Contact with this voltage will cause death or serious injury.</p> <ul style="list-style-type: none">• Turn off and disconnect power at main switch before disconnecting any cables and before servicing equipment.• This equipment must be grounded. Connect only to grounded power source.• All electrical wiring must be done by a qualified electrician and comply with all local codes and regulations.

 WARNING	
   <small>MPa / bar / PSI</small>	<p>MOVING PARTS HAZARD</p> <p>Moving parts can pinch, cut or amputate fingers and other body parts.</p> <ul style="list-style-type: none">• Keep clear of moving parts.• Keep your hands away from the follower plate and the lip of the drum while the ram is operating.• Keep your hands away from the ram frame while the ram is operating.• Do not operate equipment with protective guards or covers removed.• Equipment can start without warning. Before checking, moving, or servicing equipment, follow the Pressure Relief Procedure and disconnect all power sources.

⚠ WARNING



SKIN INJECTION HAZARD

High-pressure fluid from gun, hose leaks, or ruptured components will pierce skin. This may look like just a cut, but it is a serious injury that can result in amputation. **Get immediate surgical treatment.**



- Do not spray without tip guard and trigger guard installed.
- Engage trigger lock when not spraying.
- Do not point gun at anyone or at any part of the body.
- Do not put your hand over the spray tip.
- Do not stop or deflect leaks with your hand, body, glove, or rag.
- Follow the **Pressure Relief Procedure** when you stop spraying and before cleaning, checking, or servicing equipment.
- Tighten all fluid connections before operating the equipment.
- Check hoses and couplings daily. Replace worn or damaged parts immediately.
- Use only Graco approved hoses. Do not remove any spring guard that is used to help protect the hose from rupture caused by kinks or bends near the couplings.









FIRE AND EXPLOSION HAZARD

Flammable fumes, such as solvent and paint fumes, in **work area** can ignite or explode. Paint or solvent flowing through the equipment can cause static sparking. To help prevent fire and explosion:



- Use equipment only in well-ventilated area.
- Eliminate all ignition sources, such as pilot lights, cigarettes, portable electric lamps, and plastic drop cloths (potential static sparking).
- Ground all equipment in the work area. See **Grounding** instructions.
- Never spray or flush solvent at high pressure.
- Keep work area free of debris, including solvent, rags and gasoline.
- Do not plug or unplug power cords, or turn power or light switches on or off when flammable fumes are present.
- Use only grounded hoses.
- Hold gun firmly to side of grounded pail when triggering into pail. Do not use pail liners unless they are anti-static or conductive.
- **Stop operation immediately** if static sparking occurs or you feel a shock. Do not use equipment until you identify and correct the problem.
- Keep a working fire extinguisher in the work area.

WARNING

 	<p>EQUIPMENT MISUSE HAZARD Misuse can cause death or serious injury.</p> <ul style="list-style-type: none"> • Do not operate the unit when fatigued or under the influence of drugs or alcohol. • Do not exceed the maximum working pressure or temperature rating of the lowest rated system component. See Technical Specifications in all equipment manuals. • Use fluids and solvents that are compatible with equipment wetted parts. See Technical Specifications in all equipment manuals. Read fluid and solvent manufacturer’s warnings. For complete information about your material, request Safety Data Sheets (SDSs) from distributor or retailer. • Turn off all equipment and follow the Pressure Relief Procedure when equipment is not in use. • Check equipment daily. Repair or replace worn or damaged parts immediately with genuine manufacturer’s replacement parts only. • Do not alter or modify equipment. Alterations or modifications may void agency approvals and create safety hazards. • Make sure all equipment is rated and approved for the environment in which you are using it. • Use equipment only for its intended purpose. Call your distributor for information. • Route hoses and cables away from traffic areas, sharp edges, moving parts, and hot surfaces. • Do not kink or over bend hoses or use hoses to pull equipment. • Keep children and animals away from work area. • Comply with all applicable safety regulations.
	<p>SPLATTER HAZARD Hot or toxic fluid can cause serious injury if splashed in the eyes or on skin. During blow off of platen, splatter may occur.</p> <ul style="list-style-type: none"> • Use minimum air pressure when removing platen from drum.
	<p>BURN HAZARD Equipment surfaces and fluid that is heated can become very hot during operation. To avoid severe burns:</p> <ul style="list-style-type: none"> • Do not touch hot fluid or equipment.
	<p>TOXIC FLUID OR FUMES HAZARD Toxic fluids or fumes can cause serious injury or death if splashed in the eyes or on skin, inhaled, or swallowed.</p> <ul style="list-style-type: none"> • Read Safety Data Sheets (SDSs) to know the specific hazards of the fluids you are using. • Store hazardous fluid in approved containers, and dispose of it according to applicable guidelines.
	<p>PERSONAL PROTECTIVE EQUIPMENT Wear appropriate protective equipment when in the work area to help prevent serious injury, including eye injury, hearing loss, inhalation of toxic fumes, and burns. Protective equipment includes but is not limited to:</p> <ul style="list-style-type: none"> • Protective eyewear, and hearing protection. • Respirators, protective clothing, and gloves as recommended by the fluid and solvent manufacturer.

Uncrating the System

The E-Flo UniDrum Supply System was carefully packaged for shipment by Graco. When the system arrives, perform the following procedure to uncrate the system.

NOTICE

Moving the system off of the pallet without following the uncrating procedure can damage the equipment.

To uncrate the system, perform the following steps:

1. Inspect the crate carefully for shipping damage. Contact the carrier promptly if damage is discovered.
2. Remove the plywood sides and top of the crate.
3. Inspect the contents carefully. There should not be any loose or damaged parts.
4. Compare the packing slip against all items included in the crate. Report any shortages or other inspection problems immediately.
5. Remove the band straps that hold the UniDrum to the pallet.
6. The UniDrum is ready for installation. Before installing the system, read the **General Description** section on page 16 to become familiar with the system components.

Overview

Installation Overview

The location of the UniDrum should allow for easy loading and unloading of the 300 gallon (1200 liter) magnadrum, 1000 liter totes, or other tote drums with either a forklift truck or pallet-jack hand truck.

The E-Flo UniDrum Supply System must be leveled and mounted on a horizontal floor. An unlevelled condition can keep the UniDrum from operating properly.

Anchor the frame's four foot pads securely to the floor. The anchor bolts should be sized with sufficient safety factor to withstand the downward force of the follower plate and other objects that can push the frame off the floor.

Operation Overview

Prepare the Operator

All persons who operate the equipment must be trained in the safe, efficient operation of all system components as well as the proper handling of all fluids. All operators must thoroughly read all instruction manuals, tags, and safety labels before operating the equipment.

Overview

The E-Flo UniDrum Supply System uses two electric driven reciprocating Pumps (C) on each Supply Unit. Each Supply Unit pumps material out of a tote.

There are sensors to determine if the drum is in place and if the platen is in the drum. The pump and automatic ram down process will not enable until the drum is in place and the platen is in the drum.

General Functional Description

The E-Flo UniDrum Supply System can be setup for automatic Pump crossover, which will alternate between the LH and RH Supply Units. This dual supply system setup (controlled by customer PLC) virtually eliminates material replenishment downtime.

The E-Flo UniDrum Supply System allows the operator to load the material drum into the RH Supply Unit (B) while the LH Supply Unit (A) drum is being emptied. When the Supply Unit changeover occurs, the operator unloads the empty drum at the LH Supply Unit (A) while the RH Supply Unit (B) drum is being emptied. The cycle is repeated as many times as needed.

Supply Unit Startup

There are a series of steps that must be followed in sequential order to startup the system. Make sure to supply electrical power, supply air power, turn the System Disconnect Switch (AL) ON, flush the system, and load material. See **Initial System Startup Procedure** on page 32.

Supply Unit Operation

Depending upon the system setup, at any time during operation, the operator can:

- Stop the Pumps and relieve ram pressure at the Supply Unit.
- Shutdown the system.

At the Supply Unit (A, B), the Follower Plate (D) must be raised to load the drum into the Supply Unit. The Follower Plate (D) is lowered by the operator directly into the drum. The Pumps are turned on using the ADM, which controls the electric drivers that deliver material. See **ADM Run Screens** on page 34. The Follower Plate (D) is pressurized, and material is pumped from the drum through the outlet ports on the Pumps via a supply hose to one or more targeted applications.

Supply Unit Shutdown

For system shutdown, the operator turns off the Pumps (C) and depressurizes the system. Depending upon the type of material, the operator may choose to raise the Follower Plate (D) from the drum or keep the Follower Plate (D) lowered in the drum to prevent the material from being contaminated. Some materials will harden or congeal when exposed to air or used past their shelf life. Material should be kept covered when it is not being used and uncovered when it is ready to use.

Powering the Ram Externally

Connecting 24VDC to the customer supplied 24VDC (AM) input allows the control box operate when the Disconnect (AL) is turned OFF, including the ram UP and DOWN motion.

Component Identification

NOTE: FIG. 1 and FIG. 2 shows the typical E-Flo UniDrum Supply Unit equipped with electric motors.

1000 Liter Units

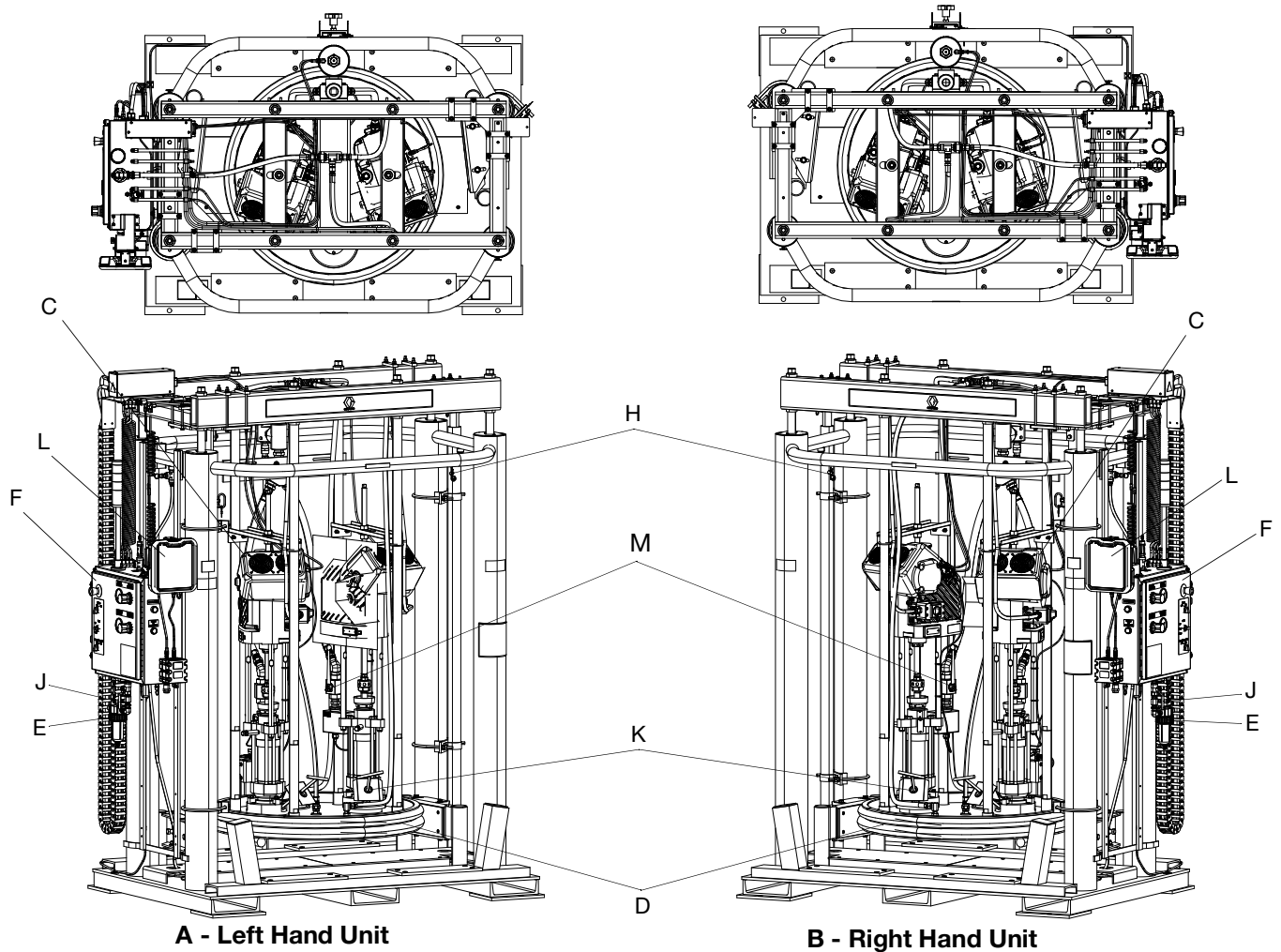

FIG. 1: E-Flo UniDrum Supply Units with Electric Motors

Key:

- A Left Hand (LH) Supply Unit
- B Right Hand (RH) Supply Unit
- C Dura-Flo Pumps with Electric Motors (2 units)
- D Follower Plate
- E Main Air Inlet
- F Control Box
- H Safety Pins
- J Main Air Shutoff Valve
- K Bleed Stick and Port
- L Advanced Display Module (ADM)
- M Ball Valve

300 Gallon Units

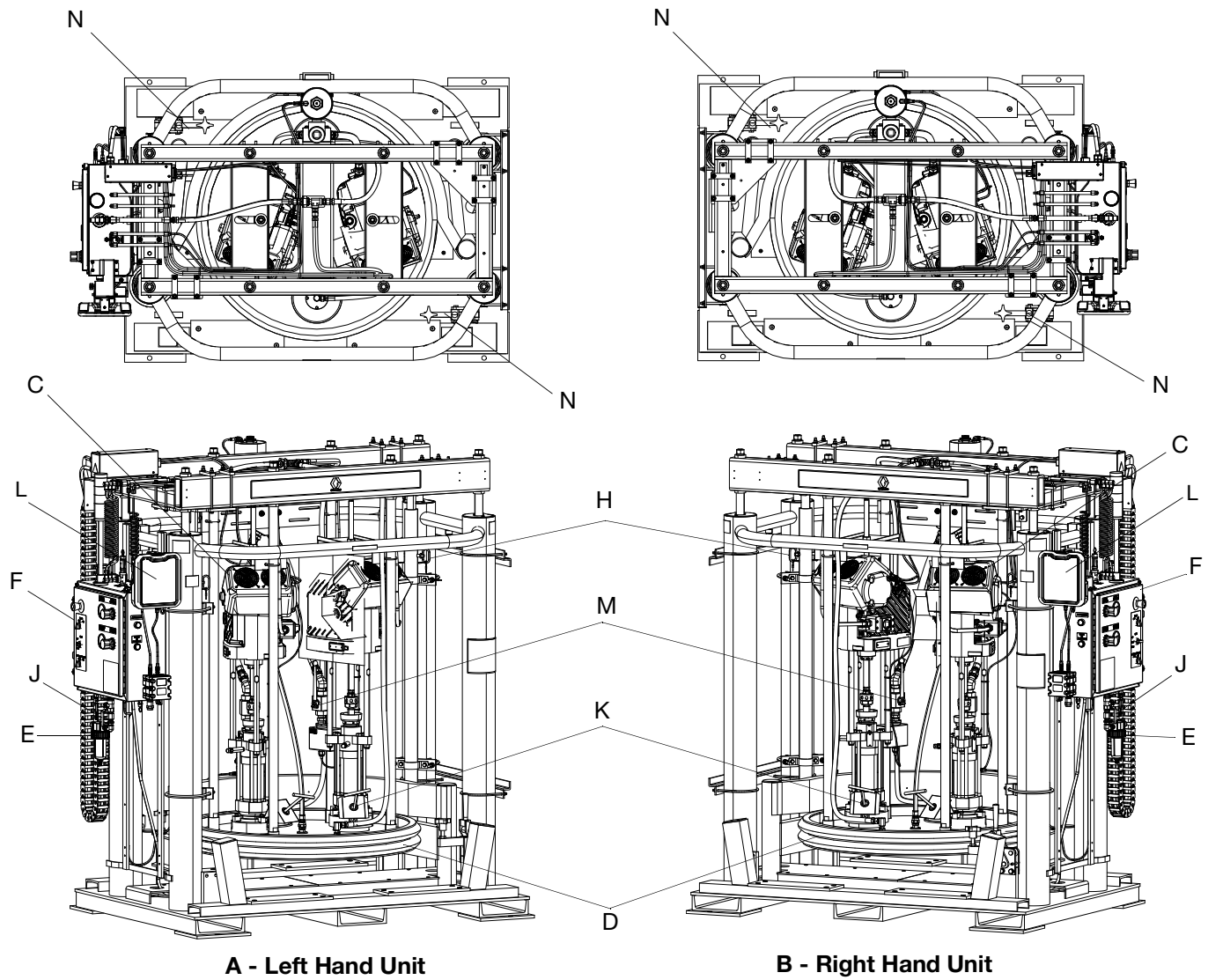

FIG. 2: E-Flo UniDrum Supply Units with Electric Motors

Key:

- A Left Hand (LH) Supply Unit
- B Right Hand (RH) Supply Unit
- C Dura-Flo Pumps with Electric Motors (2 units)
- D Follower Plate
- E Main Air Inlet
- F Control Box
- H Safety Pins
- J Main Air Shutoff Valve
- K Bleed Stick and Port
- L Advanced Display Module (ADM)
- M Ball Valve
- N Drum Clamps

Control Box

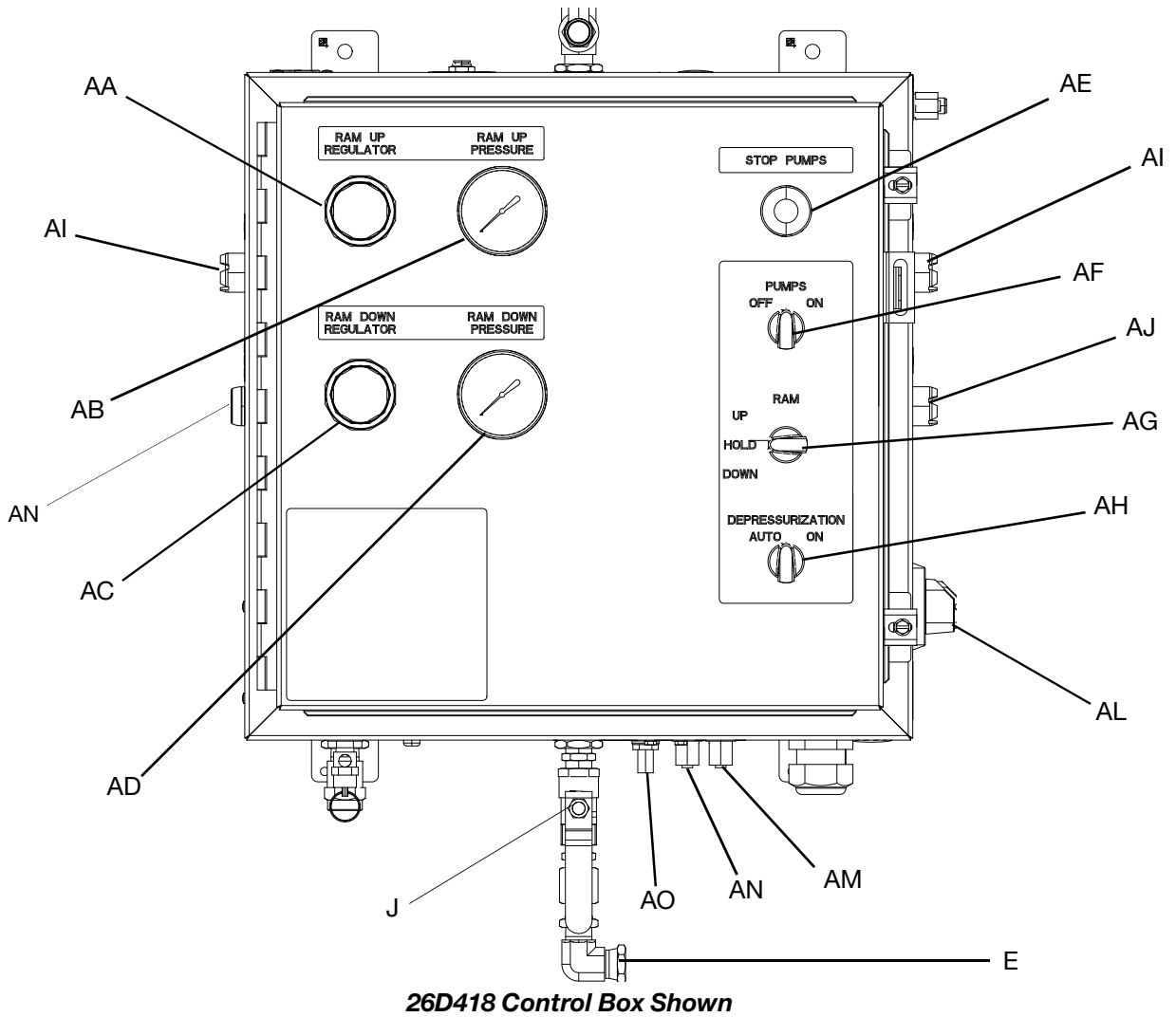

FIG. 3: Control Box

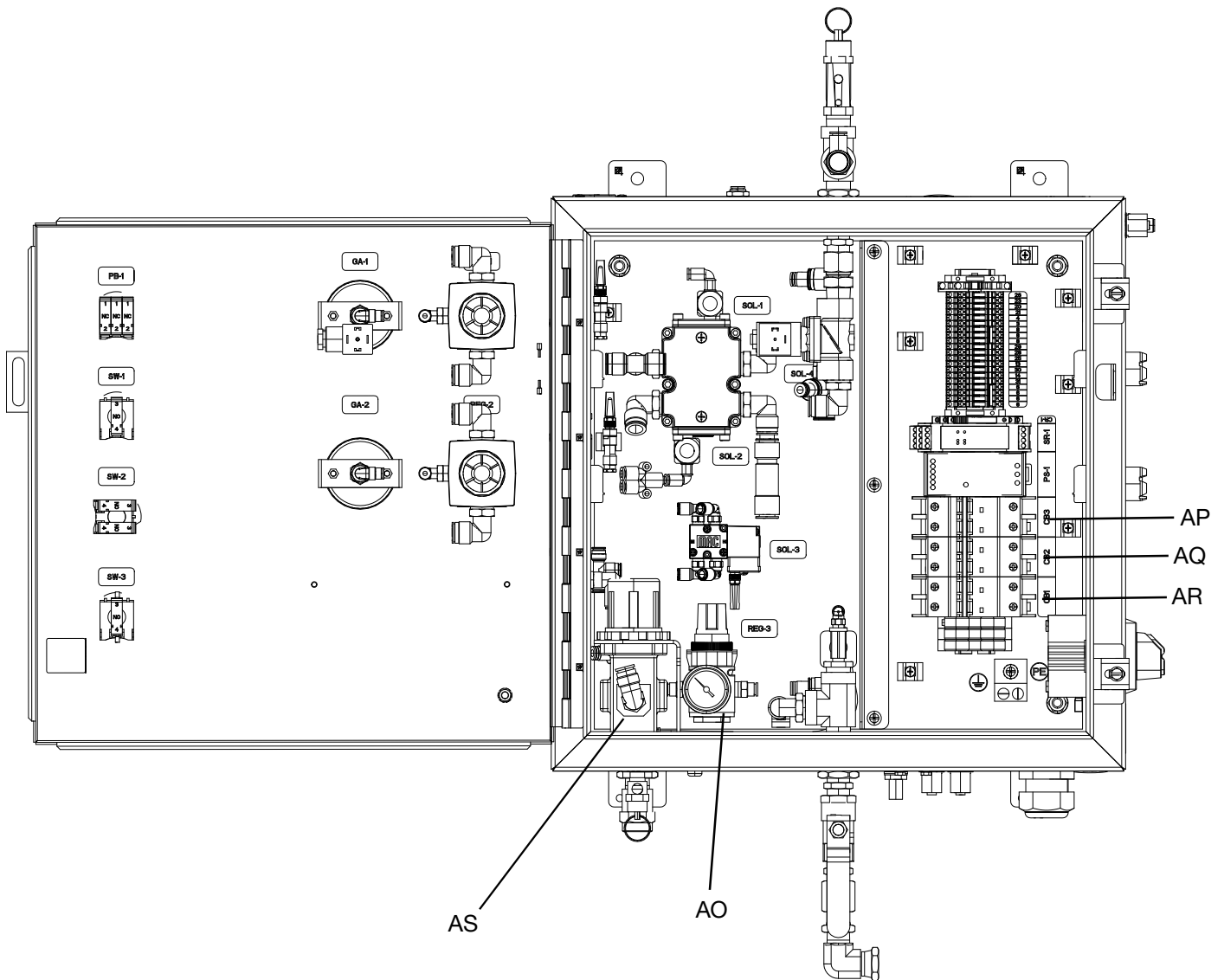

Fig. 4: Control Box Interior

Control Box Switches and Indicators

Use the table and FIG. 3 when operating the switches and reading the indicators on the Control Box (F).

Ref.	Button/Switch/Gauge		What it Does
AA	Ram Up Air Regulator		Controls the air pressure used to raise the ram assembly.
AB	Ram Up Air Pressure Gauge		Indicates the ram UP pressure setting.
AC	Ram Down Air Regulator		Controls the air pressure used to lower the ram assembly.
AD	Ram Down Air Pressure Gauge		Indicates the ram DOWN pressure setting.
AE	Stop Pumps Button		Stops movement of the pumps on the active Supply Unit, and will cross over to the inactive Supply Unit if using a tandem system.
AF	Pumps On/Off Switch		Turns the pumps ON and OFF.
AG	Ram Position Switch	UP	Allows the Ram to raise the Follower Plate (D).
		HOLD	Holds the Ram and Follower Plate (D) in the current position.
		DOWN	Allows the Ram to lower the Follower Plate (D).
AH	Depressurization Switch		Opens and closes the valve that relieves material pressure from the hoses.
AI	Ram Actuation Buttons		Raises or lowers the Follower Plate (D) when the Ram Position Switch (AG) is set to UP or DOWN.
AJ	Follower Plate Blowoff Button		Allows air into the drum to help remove the Follower Plate (D).
AL	Disconnect Switch		Turns the main electrical ON and OFF.
AN	Drum in Position Indicator		Indicates the drum is placed under the Follower Plate (D).
AO	R3 Regulator		Maintains air pressure on top of the ram cylinders to prevent the Follower Plate (D) from raising too quickly out of the drum.
AP	Power Supply Circuit Breaker		Turns the power ON and OFF to the DC power supply.
AQ	Electric Driver #2 Circuit Breaker		Turns the power ON and OFF to electric driver #2.
AR	Electric Driver #1 Circuit Breaker		Turns the power ON and OFF to electric driver #1.
AS	Blowoff Air Regulator		Controls the air that assists with removing the Follower Plate (D) from the drum.
AT	Drum in Place		Connection for the drum in place sensor.
AU	Tandem Connection		Connection for the communication cable between Tandem Supply Units.
AV	Customer I/O and Customer Supplied 24VDC		Customer input signal for the Stop Pumps Button (AE). Customer supplied 24VDC.
J	Main Air Shutoff Valve		Opens air supply line to the Control Box (F).

General Description

A general description of the E-Flo UniDrum Supply System helps the installers and operators become familiar with the system components. Contact your Graco distributor for help in choosing accessories to suit your particular needs.

Before you install the system, you should be familiar with the parts described in the following paragraphs.

System Components

See FIG. 1 on page 11.

- **UniDrum Supply Unit (A,B)** is usually setup to alternate the material supply operation between the left hand (LH) and right hand (RH) Supply Units, which is accomplished using a combination of software programming (not provided by Graco) and manual operators. Drum changeovers occur after the Follower Plate (D) has reached its preset empty limit level in the drum. Alternating between Supply Units eliminates the downtime that is usually expended unloading an empty drum and reloading a full drum.
 - LH Supply Unit (A) accommodates one tote. The LH Supply Unit has a local Control Box (F).
 - RH Supply Unit (B) accommodates one tote. The RH Supply Unit has a local Control Box (F).
- The **Advanced Display Module (ADM) (L)** controls the function of the electric drivers and pumps, and is used to set the pressure or flow.
- The two **Dura-Flo™ Pumps (C)** have electric motors. The Pumps evacuate material from the drum.
- **The Follower Plate (D)** is connected to the ram assembly and is designed to apply an even amount of pressure to the material in the drum. With the Follower Plate in its raised position, the operator moves a drum inside the Ram assembly frame. The Follower Plate is lowered directly on top of the material in the drum. When pressure is applied to the Follower Plate, the material is pumped out of the drum through hoses, which are attached to the Pump outlet ports. When the drum is empty, the operator raises the Follower Plate, removes the empty drum. The process is repeated when another drum is ready to be unloaded.

- The **Safety Pins (H)** are used to keep the ram from lowering while in the fully raised position during drum changes or maintenance of the supply system.
- **Main Air Shutoff Valve (J)** is used to open or shutoff the air supply to the entire Supply Unit (A,B).

Control Box

See FIG. 3 on page 13 and FIG. 4 on page 14.

The Control Box (F) includes the following system components. For more information, refer to the **Electrical Diagrams** on page 96 and the **Pneumatic Diagram** on page 101.

- Follower Vent Valve (AH) is activated to open the vent to relieve container pressure.
- Ram Up Push Button (AI) turns on air pressure to raise the Follower Plate (D) when used in conjunction with the Ram Position Switch (AG).
- The Ram Position Switch (AG) performs the following three functions:
 - Place the switch in the RAISE position to raise the Follower Plate (D).
 - Place the switch in the HOLD/NEUTRAL position to hold the Follower Plate (D) in the current position.
 - Place the switch in the LOWER position to lower the Follower Plate (D).

Advanced Display Module (ADM)

Advanced Display Module (ADM)



The ADM display shows graphical and text information related to setup operations.







NOTE: The ADM is only used to control the Pumps (C). The ram is controlled by the pushbuttons and switches located on the Control Box (F). See **Control Box** on page 13.

NOTICE

To prevent damage to the buttons, do not press buttons with sharp objects such as pens, plastic cards, or fingernails.

FIG. 5: Advanced Display Module (ADM)

ADM Keys and Indicators

Icon	Function
 Startup/Shutdown Key and Indicator	Press to startup or shutdown the electric pumps.
 Stop	Press to stop all pump processes. This is not a safety or emergency stop.
 Soft Keys	Press to select the specific screen or operation shown on the display directly next to each key.
 Navigation Keys	<ul style="list-style-type: none"> Left/Right Arrows: Use to move from screen to screen. Up/Down Arrows: Use to move among fields on a screen, items on a drop-down menu, or multiple screens within a function.
Numeric Keypad	Use to input values.
 Cancel	Use to cancel a data entry field.
 Setup	Press to enter or exit Setup mode.
 Enter	Press to choose a field to update, to make a selection, to save a selection or value, to enter a screen, or to acknowledge an event.

ADM Component Identification

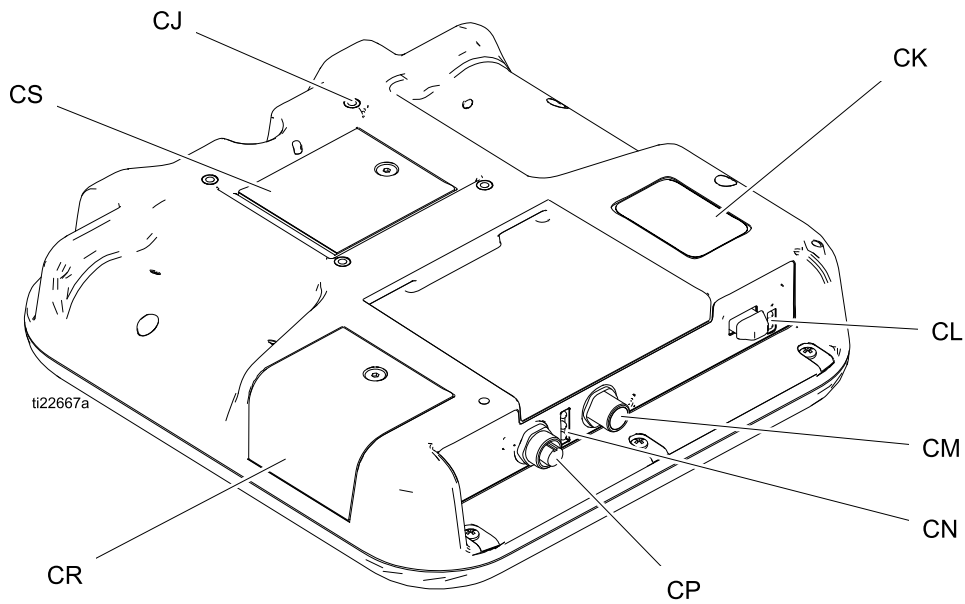



Fig. 6: ADM Component Identification

Ref.	Description
CJ	Flat Panel Mount (VESA 100)
CK	Model and Serial Number
CL	USB Port and Status LEDs
CM	CAN Cable Connection
CN	Module Status LEDs
CP	Accessory Cable Connection
CR	Token Access Cover
CS	Battery Access Cover

ADM LED Status Descriptions

LED	Conditions	Description
 System Status	Green Solid	Run Mode, System On
	Green Flashing	Setup Mode, System On
	Yellow Solid	Run Mode, System Off
	Yellow Flashing	Setup Mode, System Off
USB Status (CL)	Green Flashing	Data recording in progress
	Yellow Solid	Downloading information to USB
	Green and Yellow Flashing	ADM is busy, USB cannot transfer information when in this mode
ADM Status (CN)	Green Solid	Power applied to module
	Yellow Flashing	Active Communication
	Red Steady Flashing	Software upload from token in progress
	Red Random Flashing or Solid	Module error exists

ADM Display Details

Power Up Screen

The following screen appears when the ADM is powered up. It remains on while the ADM runs through initialization and establishes communication with other modules in the system.



Menu Bar

The menu bar appears at the top of each screen (the following image is only an example).

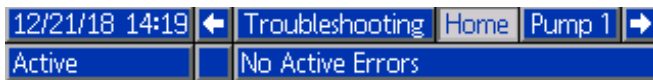

Date and Time

The date and time are always displayed in one of the following formats. The time is always displayed as a 24-hour clock.

- DD/MM/YY HH:MM
- YY/MM/DD HH:MM
- MM/DD/YY HH:MM

Arrows

The left and right arrows are only visible when screen navigation is allowed.

Screen Menu

The screen menu indicates the currently active screen, which is highlighted. It also indicates the associated screens that are available by scrolling left and right.

System Mode

The current system mode is displayed at the lower left of the menu bar.

Status

The current system status is displayed at the lower right of the menu bar.

Alarm/Deviation

The current system error is displayed in the middle of the menu bar. There are three possibilities.

Icon	Function
No Icon	No information or no error has occurred
	Advisory
	Deviation
	Alarm

Soft Keys

Icons next to the soft keys indicate which mode or action is associated with each soft key. Soft keys that do not have an icon next to them are not active in the current screen.

NOTICE

To prevent damage to the soft key buttons, do not press buttons with sharp objects such as pens, plastic cards, or fingernails.

Navigating the Screens

There are two sets of screens:

The Run screens control operations and display pump status and data.

The Setup screens control pump parameters and advanced features.

Press  on any Run screen to enter the Setup screens. If the system has a password lock, the Password screen displays. If the system is not locked (password is set to 0000), Unit 1 - Pump 1 Setup Screen displays.

Press  on any Setup screen to return to the Run screen.

Press the Enter soft key  to activate the editing function on any screen.

Press the Exit soft key  to exit any screen.

Use the other soft keys to select the function adjacent to them.

Navigating the Screens

Set a password to allow Setup screen access (see **Advanced Setup Screen 1 – Standard ADM Settings** on page 41). Enter any number from 0001 to 9999. To remove the password, enter the current password when prompted and change the password to 0000 in Advanced Setup Screen 1.

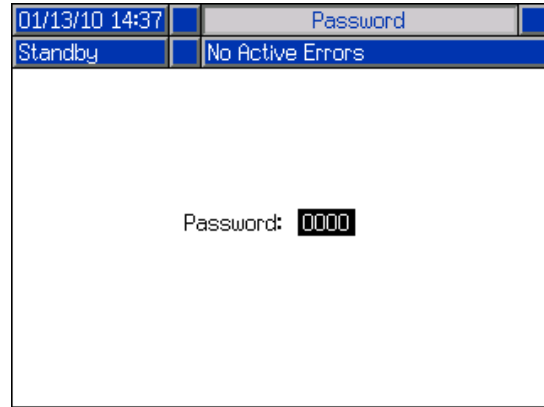











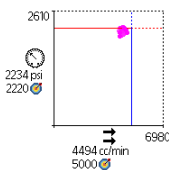
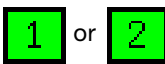
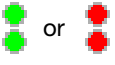

























FIG. 7













ADM Icons

Icon	Function
	Alarm - See Troubleshooting , page 56 for more information.
	Deviation - See Troubleshooting , page 56 for more information.
	Advisory - See Troubleshooting , page 56 for more information.
	Pressure or Pressure Mode
	Flow Rate or Flow Mode
	Target (either pressure or flow)
	<p>Unit Status - Indicates whether or not an error is active on this Supply Unit and the Unit Status. The three dots above the driver represent increasing levels of readiness and activity. From left to right:</p> <ul style="list-style-type: none"> Unit enabled/disabled (green if enabled, amber if disabled) Unit enabled, off, and not moving Unit enabled and commanded to drive, but Supply Unit is not moving (stalled) Unit enabled, commanded to drive and moving
	Pump Diving
	Communication Error
	No issues found with parameter or setting value
	Missing or unexpected parameter or setting value
	System is processing request (animated)

Icon	Function
	<p>Pressure-Flow Graph</p> <p>Dynamic graph representing the actual pressure, actual flow rate, pressure limit, and flow rate limit.</p> <p>The red line represents the pressure setpoint or limit. The blue line represents the flow rate setpoint or limit.</p> <p>When trending is disabled, a single magenta dot represents the current pressure and flow rate.</p> <p>When trending is enabled, older pressure flow data is kept on the screen and will slowly fade away over the period of about 30 seconds.</p>
	<p><i>Tandem system only:</i></p> <p>Denotes which Supply Unit is active.</p>
	<p>Drum low/empty state indicators. These indicators will appear next to each Supply Unit. The top circle represents drum low and the bottom circle represents drum empty. When green, the state is not activated (fluid level high). When red, the state is activated (fluid level low).</p>

ADM Soft Keys

Icon	Function
Unit Operation Icon	
	<i>Green:</i> Start Supply Unit
	<i>Inverted Red:</i> Stop Supply Unit
	<i>Red with Border (enabled):</i> Indicates that the Supply Unit cannot be started due to alarm.
	<i>Red with No Border (not enabled):</i> Indicates that system is not enabled and the Supply Unit cannot be started.
	<i>Yellow:</i> Indicates that the Supply Unit has an active alarm due to not being primed. The Supply Unit can be enabled via prime mode only.
 / 	Local / Remote control toggle
	System is locked in remote control via fieldbus interface.
 / 	Enable or disable pressure control (limiting) mode
 / 	Enable or disable flow control (limiting) mode
 /   / 	Enter or exit Unit priming mode. An “1” or “2” will be present in Tandem systems to indicate which Supply Unit will be primed.
 /   / 	Enter or exit depressurization mode.
 / 	<i>Tandem systems only</i> View and toggle the active Supply Unit.
	Enable or disable trending on the pressure / flow graph.
	Move pump rod to the top of the stroke

Icon	Function
	Move pump rod upward
	Move pump rod downward
	Move pump rod to the bottom of the stroke
	Search
	Troubleshoot selected error
	Previous screen
	Continue
	Calibrate
	Enter or exit manual Unit movement mode.
	Reset Cycle Counter
	Toggle between lifetime and resettable
 / 	Enter or exit edit mode for a particular screen

Installation



The E-Flo UniDrum Supply System weighs approximately 4150 lb (1882 kg). The E-Flo UniDrum Supply System should never be moved or lifted by one person. To avoid serious injury, engage an adequate number of personnel and use a forklift, hand truck, and support devices, such as a hoist when moving and installing the UniDrum.

NOTICE

Exercise care when the system is being moved to its installed location. Jarring, dropping, or tilting the frame while it is being lifted or moved can result in damage to the system.

NOTICE

Altering any plastic, metal tubing, or structure of the UniDrum can damage the equipment.

The installation procedures in this section are intended to serve as a guide for installing the E-Flo UniDrum Supply System. If you need more information, contact your Graco distributor.

Preparing the Site

Ensure that you have an adequate compressed air supply. 80 psi is required to operate the ram and drum blow off.

Keep the site clear of any obstacles or debris that could interfere with the installer's and operator's movement.

Selecting a Location for the UniDrum

Refer to **Technical Specifications** on page 105 for ram mounting and clearance dimensions.

When selecting a location for the UniDrum, keep the following in mind:

1. There should be sufficient space for installing, servicing, and using the equipment.
 - Select a convenient location for the equipment. Check that there is sufficient overhead clearance for the Pump and ram when the ram is in the fully raised position. Make sure the Air Regulators (AA, AC) for the Pumps (C) and Follower Plate (D) are fully accessible.
 - Make sure there is easy and safe access to an appropriate pneumatic source. Graco recommends a minimum of 3 feet (0.91 m) of open space in front of the Control Box (F).
2. Make sure that you will be able to level the base of the ram using metal shims.

Preparing to Install the UniDrum

Before installing the system:

- See component manuals for specific data on component requirements. Data presented here pertains to the system only.
- Have all system and subassembly documentation available during installation.
- Be sure that all non-Graco supplied hoses are adequately sized and pressure-rated to meet the system requirements.

Installing the UniDrum

To install the UniDrum, follow the procedure below. Refer to **Technical Specifications** on page 105 for ram mounting and clearance dimensions.

1. Using equipment such as a forklift or handtruck, move the UniDrum into place on the floor. Remove the shipping pallet.
2. Level the UniDrum, using metal shims.
3. Using the holes in the base as a guide, drill holes for 13 mm (1/2 in.) anchors.
4. Bolt the UniDrum to the floor using anchors that are long enough to prevent the Supply Unit from tipping.

ADM and Light Tower Kit, 26D425

Installing the ADM

NOTE: The ADM must be installed on the same control box as the CGM.

1. Turn OFF the System Disconnect Switch (AL).
2. Remove the cap plugs on the Control Box (F) the ADM will be mounted on.
3. Using the screws (121112), washers (100016), and nuts (100015), mount the bracket to the Control Box (F).
4. Place the ADM into the bracket and securely screw in the top screw, as shown in FIG. 8.

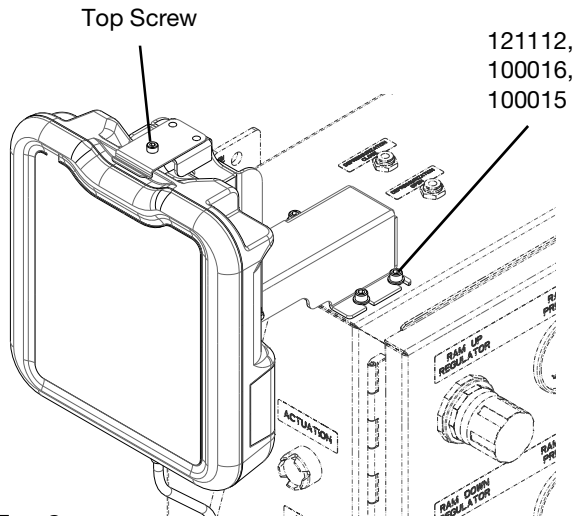

FIG. 8

5. Screw the 1.5 m CAN cable into the CAN terminal block connection (TB).

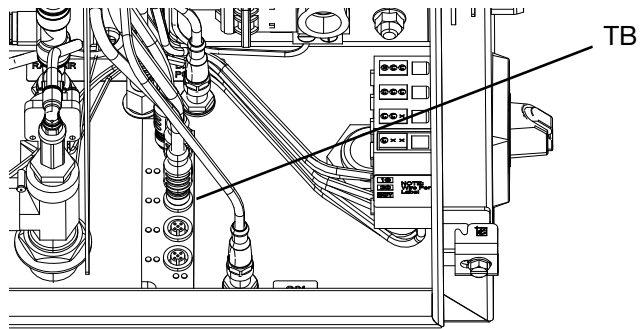

FIG. 9

6. Run the CAN cable around the outside of the Control Box (F) and through the hole under the bracket.
7. Screw the 1.5 m CAN cable into the ADM CAN Cable Connection (CM).
8. Tuck or wire tie the extra cable under the bracket so it is out of the way.

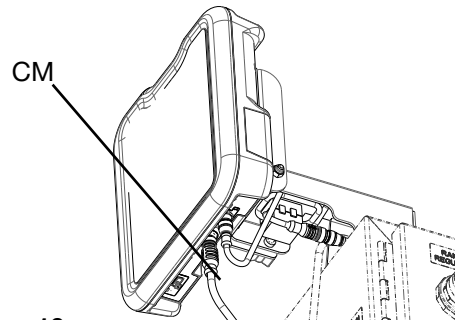

FIG. 10

Installing the Light Tower

1. Turn OFF the System Disconnect Switch (AL).
2. Remove the cap plugs on the Control Box (F) the ADM is mounted to.
3. Feed the wire on the light tower through the hold in the Control Box (F).
4. Mount the light tower to the Control Box (F) using the four screws (112310).
5. Feed the light tower cable through the hole under the bracket.
6. Screw the light tower connector tightly to the ADM accessory cable connection (CP).
7. Make a loop with the light tower cable, then clip a ferrite bead onto the loop.

- Tuck or wire tie the extra cable under the bracket so it is out of the way.

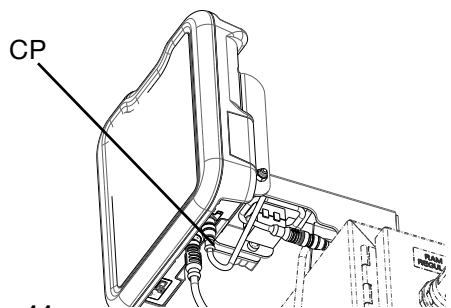

FIG. 11

Communication Gateway Module (CGM) Kits

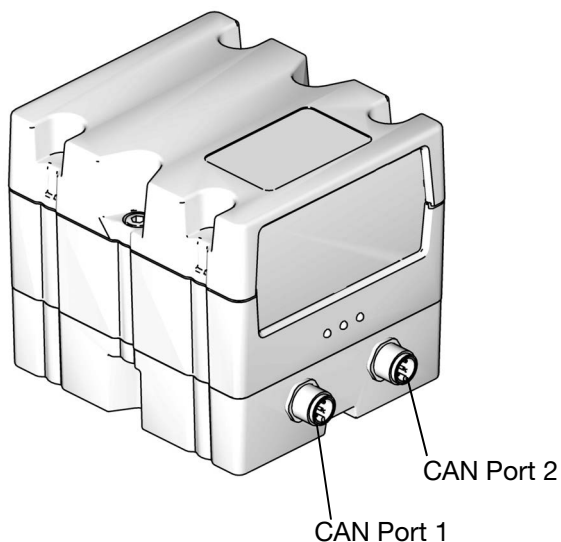

FIG. 12: CGM CAN Connections

CGM Kits

Part Number	Description
26D426	E-Flo UniDrum CGM Kit, EtherNet/IP
26D427	E-Flo UniDrum CGM Kit, DeviceNet
26D428	E-Flo UniDrum CGM Kit, PROFINET
26D429	E-Flo UniDrum CGM Kit, PROFIBUS

Installing a CGM Kit

NOTE: The CGM must be installed on the same Control Box as the ADM.

All electrical wiring must be done by a qualified electrician and comply with all local codes and regulations.				

- Turn OFF the System Disconnect Switch (AL).
- Remove the access cover from the CGM (DA). Loosen and save the two M5-0.8 x 45 mm x screws (DB), and remove the CGM (DC) from the base (DD). See FIG. 13.

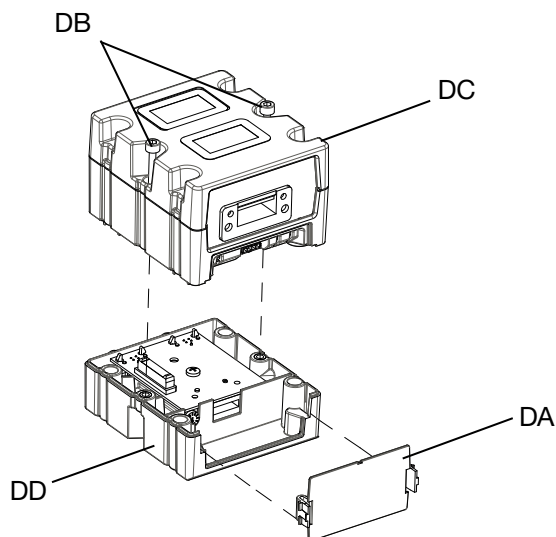

FIG. 13: Disassembling the CGM

- Using the four M4-0.7 x 20 mm mounting screws included in the kit, mount the base (DD) to the Control Box (F).
- Reattach the CGM (DC) onto the base (DD) with the two screws (DB) that were removed and saved from step 4.
- Reattach the access cover (DA).
- Unplug the cable from the ADM and plug the cable back into CGM (DC).
- Plug 0.5 m cable (121000) included in the CGM kit from the CGM to the ADM.

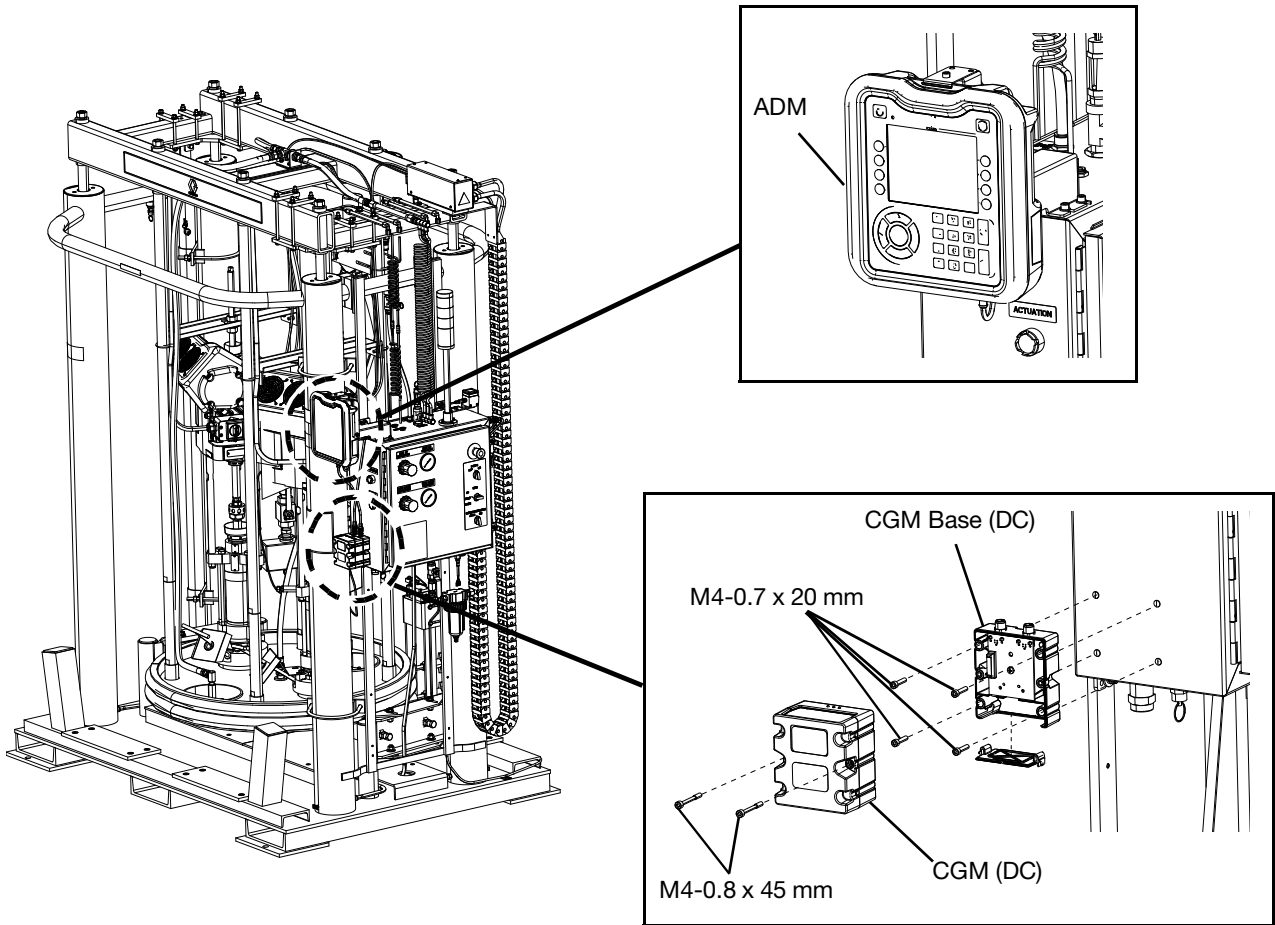

FIG. 14

8. Connect the Ethernet/IP, DeviceNet, or PROFIBUS cable to the fieldbus connection on the CGM as applicable.

9. Connect the other end of the Ethernet/IP, DeviceNet, or PROFIBUS cable to the fieldbus device.

10. Refer to the Graco Control Architecture Module programming manual for step-by-step instructions on how to update the software version of GCA modules. See **Related Manuals** on page 3.

11. Refer to the E-Flo UniDrum Supply System Operation manual for details regarding the feildbus pinout setup and to perform the setup procedure to configure the feildbus. See **Related Manuals** on page 3.

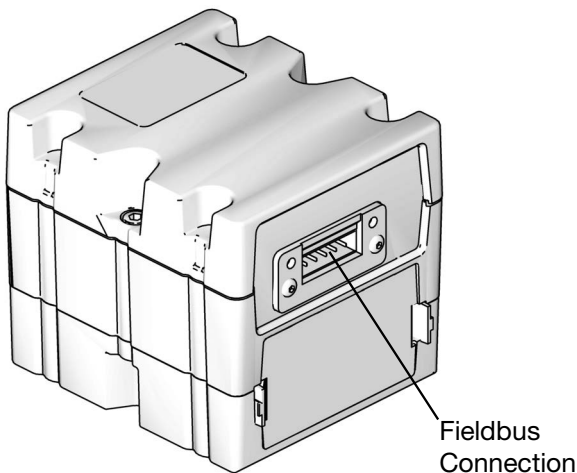

FIG. 15: CGM Fieldbus Connections

Tandem Cable Kit, 26B339

Part	Description	Qty.
121228	CABLE, CAN	1
123856	CABLE, CAN	1

To install the Tandem Cable Kit:

1. Connect the female connector of the Cable (123856) to the CAN port (JB) on the bottom of the Control Box (F) on one Supply Unit.
2. Connect the female connector of the Cable (121228) to the CAN port (JB) on the bottom of the Control Box (F) on the other Supply Unit.

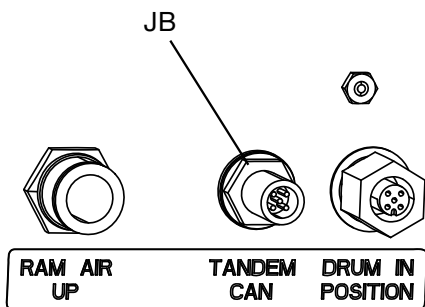
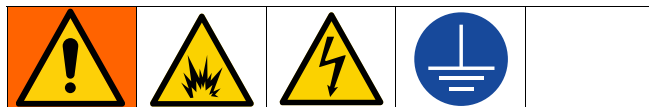

FIG. 16

Connect the male connector of the Cable (123856) into the female connector of the other Cable (121228).

Grounding



The equipment must be grounded to reduce the risk of static sparking and electric shock. Electric or static sparking can cause fumes to ignite or explode. Improper grounding can cause electric shock. Grounding provides an escape wire for the electric current.

Electric pump: the pump is grounded through the power cord.

Ram: the ram is grounded through the power cord.

Air and fluid hoses: use only electrically conductive hoses with a maximum of 500 ft. (150 m) combined hose length to ensure grounding continuity. Check the electrical resistance of the hoses. If the total resistance to ground exceeds 29 megaohms, replace the hose immediately.

Air compressor: follow manufacturer's recommendations.



Fluid supply container: follow local code.

Solvent pails used when flushing: follow local code. Use only conductive metal pails, placed on a grounded surface. Do not place the pail on a non-conductive surface, such as paper or cardboard, which interrupts the grounding continuity.

Control Box (F): the Control Box is grounded through the power cord and grounding lug on the back panel of the Control Box.

Connecting Power to the Control Box

Perform the following procedure to connect the power to the Control Box (F).

				
All electrical wiring must be done by a qualified electrician and comply with all local codes and regulations.				

NOTICE
If power and grounding connections are not done properly, the equipment may be damaged and the warranty will be voided.

Use copper conductors rated at least 60°C.

Have a qualified electrician connect the Control Box (F) to an electrical source with an appropriately sized disconnect and branch circuit protection that has the following ratings:

	Hz	Phase	Circuit Breaker
240V Models	50/60	3Ø	20 Amp
400VY Models	50	3Ø	35 Amp
480V Models	60	3Ø	10 Amp

To connect the Control Box (F) to the power source, perform the following steps:

1. Shut off system power at the main circuit breaker and verify the System Disconnect (AL) is turned off.
2. Open the door of the Control Box (F).
3. Connect a ground wire to the ground lug (GS) shown in FIG. 17.
4. Connect power wires to the corresponding locations per the label on the Control Box's (F) Disconnect Switch (AL). See FIG. 17. Torque the disconnect terminals to 17.7 in. lb. (2 N•m). For more information, refer to **Electrical Diagrams** on page 96.
5. Replace the cover on the Control Box (F).

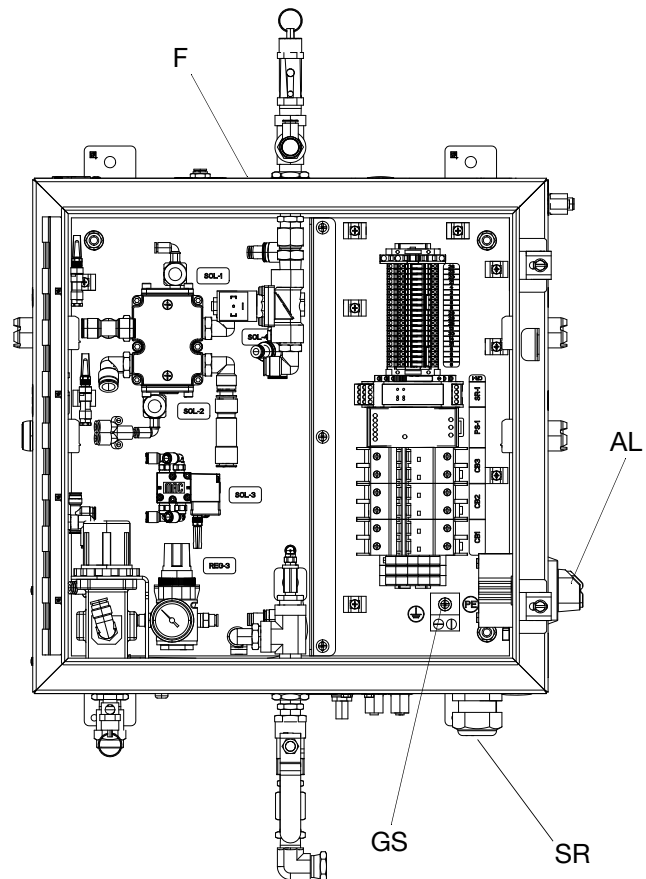

FIG. 17

Connecting the Air Supply Lines to the UniDrum

Perform the following procedure to connect the input air supply lines to the E-Flo UniDrum Supply System.

Connecting Air Supply Lines to the Supply Units

To connect the main air supply to the LH and RH Supply Units (A, B), perform the following steps:

Have a qualified technician connect both Supply Units to an air supply source that has the following required ratings:

Description	Requirements
Inlet Port Size:	1 in. npt(f)
Air Volume:	450 cfm (maximum)
Input Air:	80 psi (5.5 bar, 0.55 MPa)

1. Check the air supply to ensure that it is properly sized and pressure-rated for this system.
2. Connect the air supply line to the 1 in. npt Main Air Inlet (E).

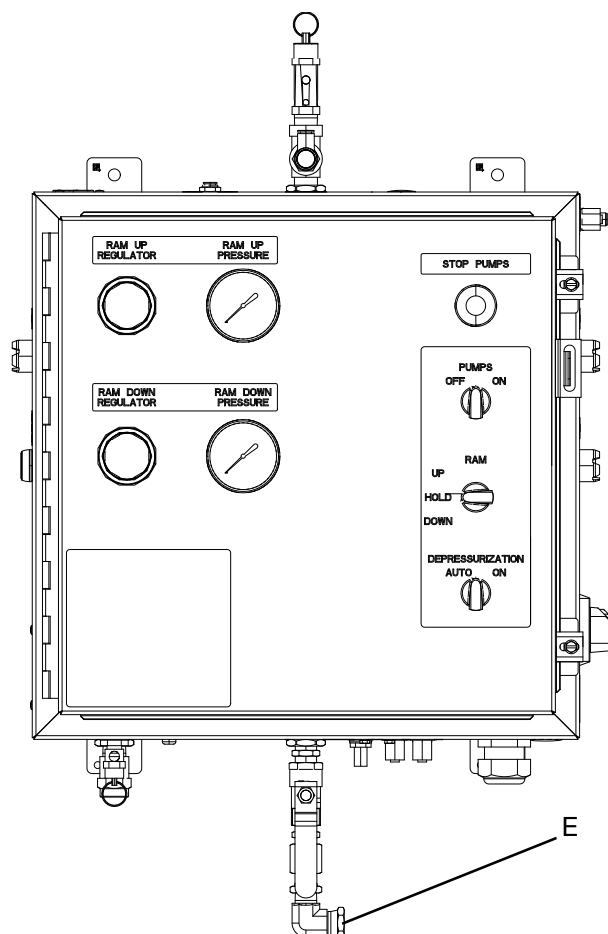

FIG. 18

Connecting Output Hose to the Pumps

It is the customer's responsibility to have the fluid supply hose ready for connection to the 1-1/4 in. npft(f) fluid outlet on the fluid manifold.

NOTE: The fluid supply hose must move freely without kinking when the Pumps move up and down.

Check the fluid supply hose to ensure it is properly sized and pressure-rated for this system. Use only electrically conductive hoses. The fluid supply hose should have spring guards on both ends. Connect the fluid supply hose to the fluid manifold outlet.

NOTICE

There must be a minimum of 10 feet (3 m) of fluid supply hose on the outlet to prevent damage to the Supply Unit.

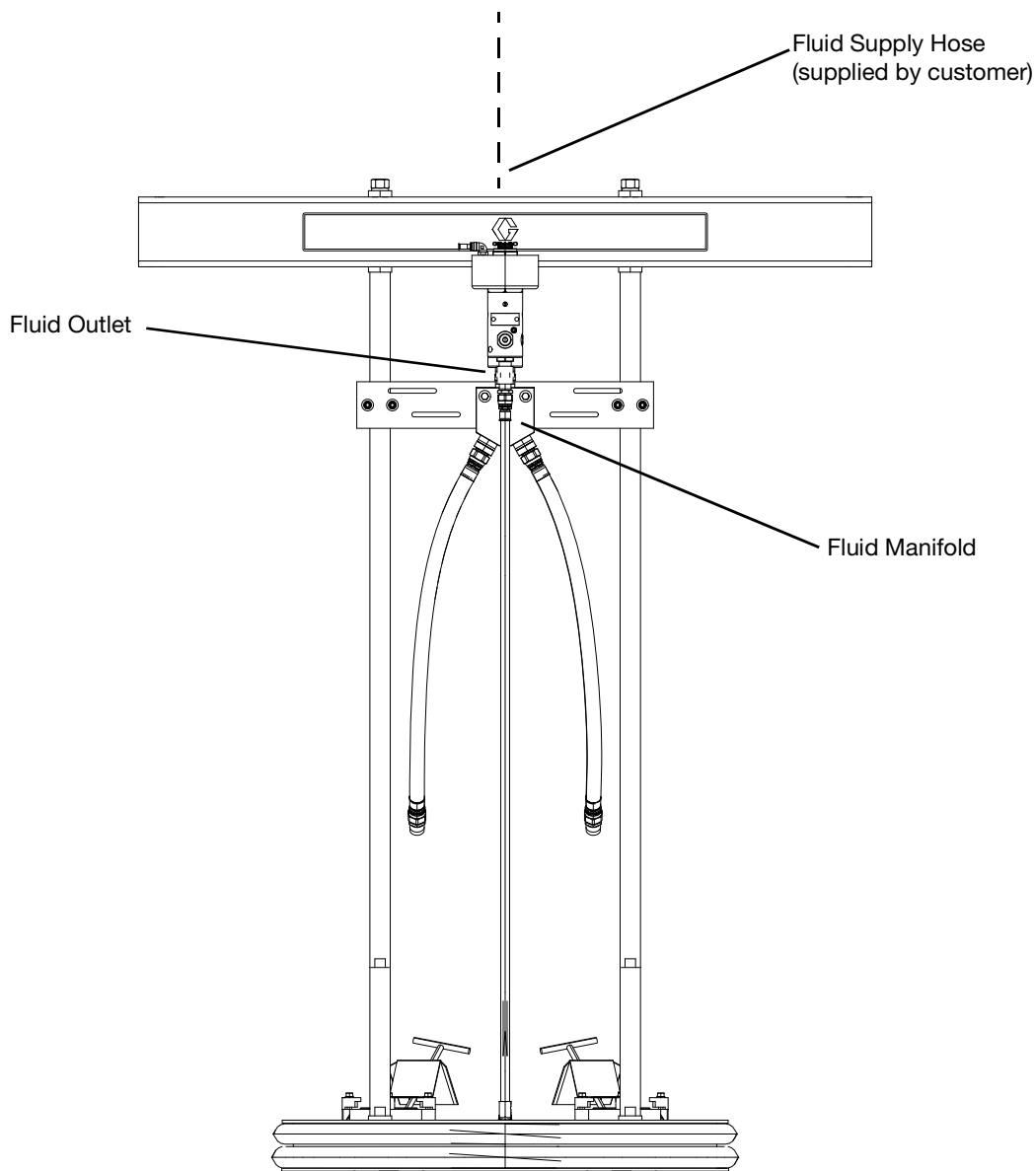

FIG. 19

Flushing the System Before Initial Use

Flushing the system before its initial use can prevent material contamination, which may cause the material to fail or perform poorly.

The equipment was tested with lightweight oil, which is left in the fluid passages to protect parts. To avoid contaminating your fluid with oil, flush the equipment with a compatible solvent before using the equipment.



To avoid fire and explosion, always ground equipment and waste container. To avoid static sparking and injury from splashing, always flush at the lowest possible pressure.

NOTICE

There must be a minimum of 10 feet (3 m) of fluid supply hose on the outlet to prevent damage to the Supply Unit.

To flush the system, perform the following procedure:

1. Select the material for the initial material load.
2. Verify whether the factory-test oil and the initial material load are compatible:
 - a. If the two substances are compatible, omit the remaining steps in this procedure and perform the **Initial System Startup Procedure** on page 32.
 - b. If the two substances are incompatible, perform the remaining steps in this procedure to flush the system.

NOTE: Use fluids and solvents that are chemically compatible with the equipment wetted parts. See the **Technical Specifications** sections of all the equipment manuals. Always read the material manufacturer's literature before using fluid or solvent in this Pump.

3. Select a drum containing a compatible material that can dissolve, clean, and eliminate the factory test

oil from the system. If necessary, check with the material supplier for a recommended flush material.

4. Before flushing, be sure the entire system and flushing drums are properly grounded. Refer to **Grounding** on page 27.
5. Perform steps 1 through 7 of the **Load Material** procedure on page 42 to load the drum containing the solvent.
6. Run the flush material through the system for approximately 1 to 2 minutes.
7. Remove the drum containing the flush material.

Adjusting the Drum Lid Holder Before Initial Use - 300 Gallon Systems

1. Adjust the lower drum lid holder channel as low as it will go on the side of the ram post. The channel should be 1 in. (25 mm) higher from the floor in the front compared to the back.

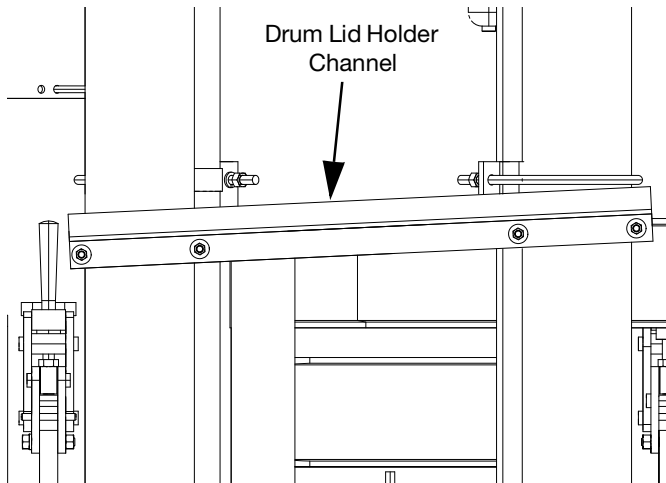
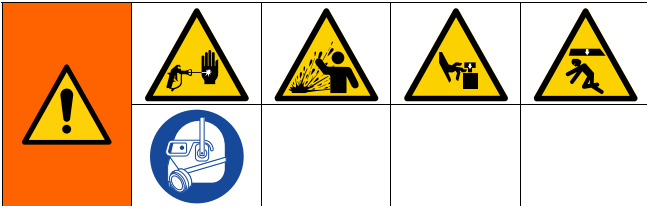

FIG. 20

2. Loosen the upper drum lid holder channel. Place the lid in the center of the lower channel. Lower the upper channel until it contacts the lid. Tilt the rear of the upper channel down 1/2 to 1 in. (13 to 25 mm) and tighten all bolts.
3. The lid should roll in and out from the front and not roll out the rear.

Initial System Startup Procedure



To reduce the risk of serious bodily injury, such as skin injection or splashing fluid in the eyes or on the skin, always wear eye protection and protective clothing when installing, operating, or servicing this equipment.

Moving equipment parts can cause personal injury, including severing of hands or fingers. Keep hands and fingers away from the Follower Plate, Pump inlets, and the drum when raising or lowering the Follower Plate to reduce the risk of pinching or amputating hands or fingers.

NOTICE

The use of a non-compatible lubricant can cause material contamination or inadequate performance. Use only a lubricant compatible with the material to be pumped. Check with the material supplier for a recommended lubricant.

To help avoid damage to equipment, do not use a drum of material that has been dented or otherwise damaged; damage to the Follower Plate wiper may result.

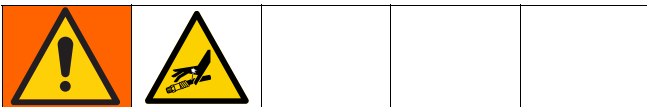

To reduce risk of injury or equipment damage:

- Make sure all material hose connections are secure.
- Do not pressurize the system until you have verified the system is ready and it is safe to do so.

Settings for Initial System Startup

The initial system startup procedure contains the checklist of settings, adjustments, and procedural steps that must be completed before the system is ready for daily operation.



NOTE: Complete the startup procedure for the LH Supply Unit (A) first. Then, repeat the startup procedure for the RH Supply Unit (B).

Perform the initial system startup procedure as follows:

1. Check all material hoses and fittings to ensure tightness and to prevent any material leakage.
2. Check all system air lines. Make sure that all routing of air lines will not interfere with any moving components within the system.
3. Fill the packing nut/wet cup on both Pumps 1/3 full with Graco throat seal liquid (p/n 206995). Refer to instruction manual 311825 or 311827 for details.
4. Turn the System Disconnect Switch (AL) to the ON position.
5. Set the Ram Position Switch (AG) to UP, and simultaneously push both Ram Actuation Buttons (AI) to raise the Follower Plate (D) above the height of the material drum to be used.
6. Set the Ram Position Switch (AG) to HOLD/NEUTRAL.

Adjusting the Ram Up and Ram Down Air Regulators

1. Set the Ram Position Switch (AG) to UP and simultaneously push both Ram Actuation Buttons (AI). Verify that the Follower Plate (D) raises at the desired speed. If not, perform the following steps:
 - a. Adjust the Ram Up Air Regulator (AA). Turn the knob clockwise to increase the amount of air pressure and increase the Follower Plate (D) speed. Check the air gauge to verify that air pressure was increased. See FIG. 4. The air pressure factory setting is 50 psi, and it is not recommended to exceed 80 psi.
 - b. Verify that the R3 Regulator (AO) is set to between 5 and 15 psi (0.035 to 0.07 MPa, 0.35 to 0.7 bar).

				
<p>The R3 Regulator must be set to between 5 and 15 psi (0.035 to 0.07 MPa, 0.35 to 0.7 bar). Setting the R3 Regulator pressure higher than recommended can cause the Follower Plate (D) to drop and result in operator injury.</p>				

NOTICE

Failure to adjust the Regulator R3 properly can cause the platen to exit the drum at a high rate of speed, risking damage to the equipment.

- c. Repeat step 1.a until the ram raises at the desired speed.
2. Set the Ram Position Switch (AG) to DOWN while observing the Ram Down Air Pressure Gauge (AD) on the panel.
3. Adjust the Ram Down Air Regulator (AC) to 50 psi (0.34 MPa, 3.4 bar) as follows (see FIG. 4):
 - a. Turn the Ram Down Air Regulator (AC) knob clockwise to increase air pressure or counterclockwise to decrease air pressure.
 - b. Check the Ram Down Air Pressure Gauge (AD) to verify the air pressure setting. The air pressure factory setting is 50 psi, and it is not recommended to exceed 80 psi.

Drum Settings

Most of the settings have been factory set. To account for differences in drum height, use the ADM to set the drum height, low, and empty settings for your drum. See **Pump Setup Screen 6 – Drum Settings** on page 40.

1. Using the level sensor feedback, move the platen to the height of the drum. Enter the reading from the sensor to the drum height parameter on the ADM.

NOTE: When the sensor level is above the drum height, the drum not in platen alarm will be triggered.

2. Using the level sensor feedback, move the platen to the height of the drum low deviation. Enter the reading from the sensor into the low level parameter on the ADM.







NOTE: Once the drum level falls below the setpoint, the drum low deviation will be triggered.



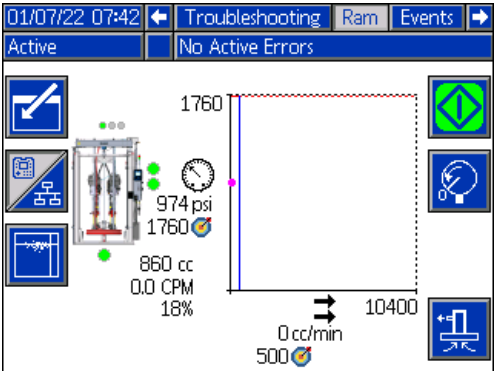



3. Using the level sensor feedback, move the platen to the height of the drum empty alarm. Enter the reading from the sensor into the empty level parameter on the ADM.



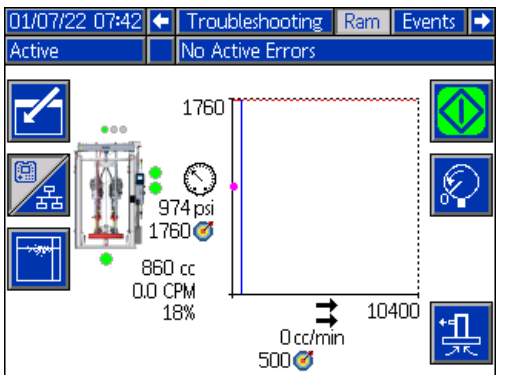

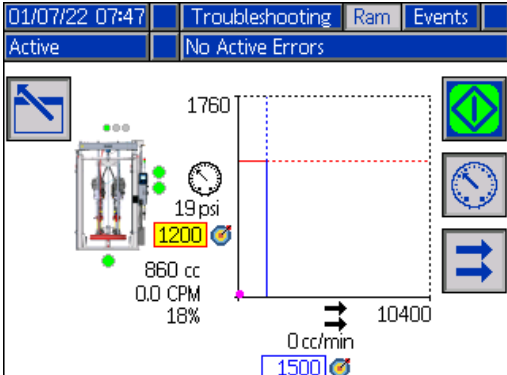
NOTE: Once the drum level falls below the setpoint, the drum empty alarm will be triggered.



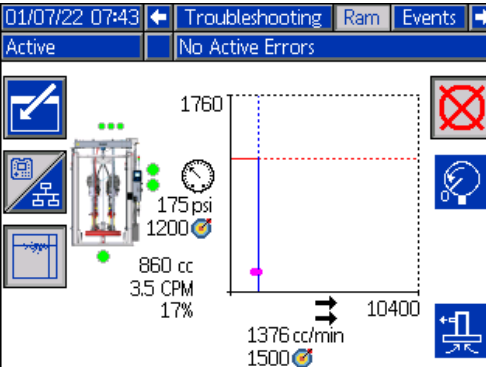

Operation

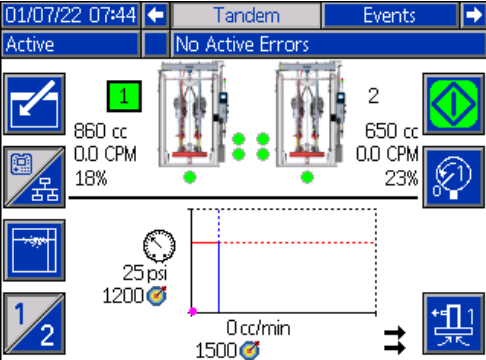
ADM Run Screens



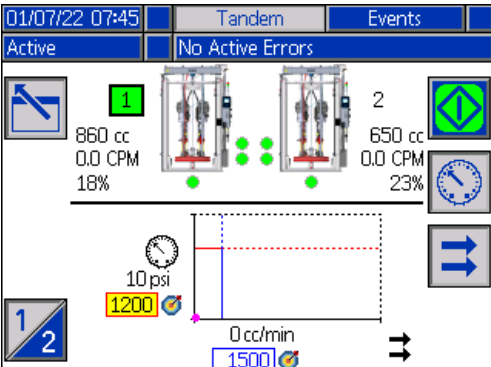

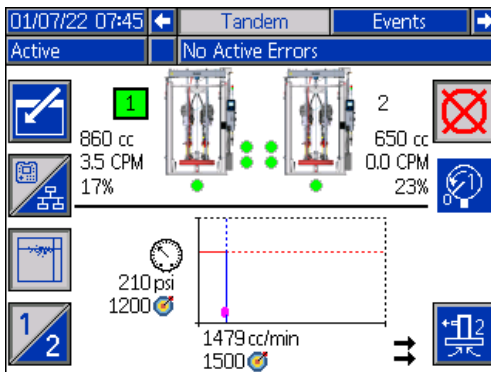

Screen	Description
	<h3>Pump Run Screen (Ram)</h3> <p>When this soft key  is displayed, the Supply Unit can be controlled locally through the display. When this soft key  is displayed the Supply Unit is controlled through fieldbus protocols.</p> <p>The  soft key on the right can be pressed to enter or exit depressurization mode. This option is only available when a fluid solenoid is installed. Selecting the button in the state shown would enter depressurization mode.</p> <p>The  soft key on the right can be pressed to enter or exit priming mode. Selecting the button in the state shown would enter priming mode.</p> <p>Information Displayed:</p> <p>A dynamic graph of target and actual performance for Supply Unit outlet pressure and flow. Target pressure and flow are represented by red and blue lines respectively. The actual outlet pressure and flow is shown by the magenta dot.</p> <p>The points will be updated at all times when running, stalled, active, inactive, etc.</p> <p>Trending icon . When not enabled, only the current pressure and flow targets are shown along with the current operating point. When enabled, one can see where the Supply Unit has been operating over time.</p> <p>Max pressure achievable with the selected Supply Unit is shown at the top of the vertical axis. The minimum pressure is zero.</p> <p>Outlet Pressure target is shown next to the target icon on the vertical axis. It is restricted to values below the max achievable pressure. Pressure is displayed in psi, bar, or MPa. Select options in Advanced Setup Screen 2.</p> <p>Actual outlet pressure is shown below the pressure icon and can be displayed in the same Supply Units described under the target pressure.</p> <p>Max flow rate achievable with the selected Supply Unit is shown at the end of the horizontal axis. The minimum flow is zero.</p>



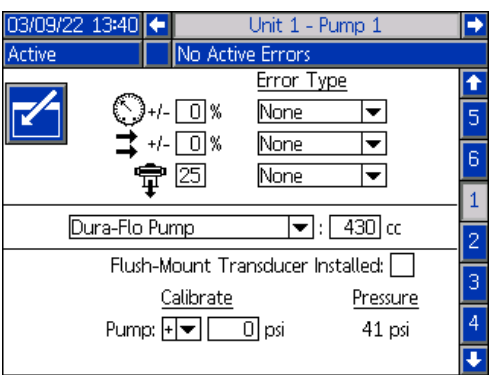





Screen	Description
	<h3>Pump Run Screen (Ram) (Continued)</h3> <p>Outlet flow rate target is shown next to the target icon on the horizontal axis. It is restricted to values below the max achievable flow. Flow rate can be displayed in cc, gal(US), gal(UK), oz(US), oz(UK), or Liters. These options can be selected in the Advanced Setup Screen 2.</p> <p>Actual outlet flow rate is shown below the flow rate icon, and can be displayed in the same Supply Units described under the flow rate target. All flow rates are calculated from the specified lower size and assume 100% volume efficiency.</p> <p>Lower Size is shown below the pressure target in cc for Supply Unit.</p> <p>Cycle Rate is shown below the pump size in CPM (cycles per minute) for Supply Unit.</p> <p>Material remaining in the drum is shown below the cycle. The percentage represents the amount of material remaining in the drum.</p> <p>Pumps operation icon . See ADM Soft Keys on page 22 for a description of this icon.</p> <p>Status of Supply Unit / drivers is shown above the Supply Unit / drivers icon and is depicted with three dots. The three dots represent increasing levels of readiness / activity from left to right. See the Icons section for description of the status lights.</p> <p>The dot below the Supply Unit / drivers icon represent the status of the drum. The dot color will be one of the following:</p> <ul style="list-style-type: none"> • Red: Drum not present • Yellow: Platen not in the drum • Green: Drum in place and the platen is in the drum <p>An indicator light can appear next to each Supply Unit to describe the state of the drum low or empty state. See the drum low/empty state section in the ADM Icons table on page 21 for more information.</p> <p>An alarm, deviation, or advisory bell will be shown above the driver if such an event is active. See Icons section.</p>
	<h3>Pump Run Screen (Ram) in Edit Mode</h3> <p>This screen is used to set the desired pressure and flow rates and enable/disable the pumps.</p> <p>The pressure and flow rate targets are set using the numeric entry boxes. Use the arrow keys to navigate between pressure and flow rate targets. Pressure and/or Flow mode are selected using soft keys on the right edge of the screen. In pressure mode , the maximum flow rate for a given pressure will be maintained. In flow mode , the maximum pressure for a given flow rate will be maintained. In pressure and flow mode (both soft keys selected), the pressure and flow can be set as desired.</p> <p>NOTE: The restriction of the down stream fluid system determines the achievable levels of pressure and flow rate.</p> <p>Load sharing is a feature that is included in the E-Flo UniDrum software. When the E-Flo UniDrum is in pressure mode only , the drivers will share the load evenly to maintain the desired pressure.</p>

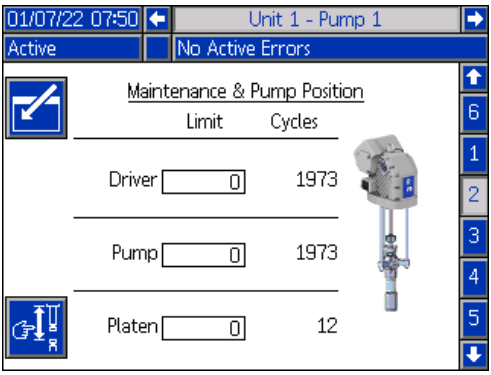
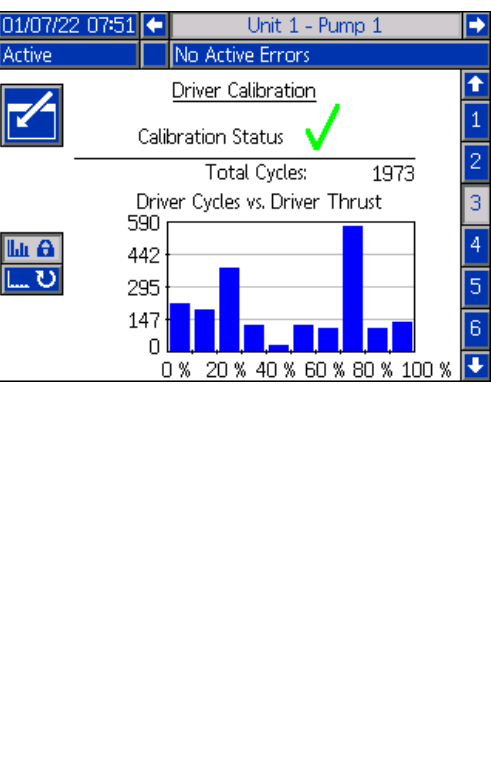

Screen	Description
	<p>Pump Run Screen (Ram) – Pumps On</p> <p>When the pumps operation icon  is gray and selected, the pumps are commanded to run and there are no active errors. Press the upper right soft key to turn off the pumps.</p> <p>Trending is enabled.</p> <p>The magenta dot is continuously placed on the screen, but fades over time.</p>
	<p>Tandem Run Screen</p> <p>See the Pump Run Screen (Ram) section on page 34 for previously described information available on this screen. The tandem system option can be selected on the system setup screen.</p> <p>In order for the tandem system to operate properly, two Supply Units must be installed and operational.</p> <p>The  soft key on the left is used to switch which Supply Unit is “active” (crossover). The 1 or 2 Supply Unit must be listed as the active Supply Unit before running. The green box around the 1 or 2 Supply Unit designations denotes the active Supply Unit. The active Supply Unit pressure and flow graph will be shown on the bottom half of the screen.</p> <p>The Supply Unit lower size, cycles per minute, and percentage of the drum material remaining are shown for each Supply Unit.</p> <p>Status icons for alarms, deviations, and advisories will display next to the Supply Unit that generated the error. See ADM Icons on page 21 for description.</p> <p>Indicator lights can appear next to each Supply Unit to describe the state of the drum low or empty state. See the drum low/empty section in the Icons table for more information.</p> <p>The maximum allowable pressure and flow rates are not shown on the dynamic pressure and flow graph. The system will still limit entered pressure and flow rate values to their maximum.</p> <p>Depressurization and priming modes can be entered for either Supply Unit 1 or 2. Press the  soft key to switch between these options for Supply Unit 1 or 2.</p> <p>NOTE: During crossover, the depressurization and priming will be stopped if active.</p> <p>A crossover cannot be completed while priming is active on either Supply Unit. Only one Supply Unit can be in priming mode at a time.</p> <p>NOTE: Unit priming can be initiated and controlled through the display even when the system is being controlled through automation.</p>

Screen	Description
	<p>Tandem Run Screen in Edit Mode</p> <p>See Unit 1 Run Screen in Edit Mode (Ram) for previously described information available on this screen.</p> <p>The main difference from the ram screen is the  soft key can be pressed to crossover between Supply Units. The pressure and flow targets for each Supply Unit can be set on this screen. The entered values will be limited to their achievable maximums.</p>
	<p>Tandem Run Screen – Pumps On</p> <p>See Pump Run Screen (Ram) section on page 34 for information available on this screen.</p> <p>Pressing the  soft key causes crossover between Supply Units.</p> <p>The system will automatically crossover while running if the active Supply Unit produces an alarm. A crossover error will occur if the inactive Supply Unit cannot be activated due to an alarm of its own.</p> <p>Depressurization mode is not available while the Supply Unit is on, but the non-active Supply Unit can be primed while the active Supply Unit is running.</p>

Setup Screens

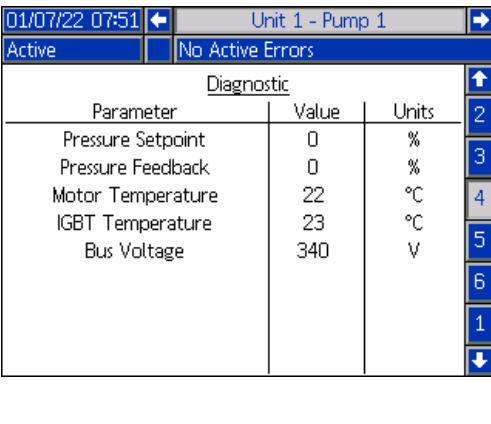
Screen	Description
	<h2 data-bbox="625 346 1209 378">Pump Setup Screen 1 – Pump Settings</h2> <p data-bbox="625 399 1323 430">NOTE: There is a pump tab for every installed pump in the system.</p> <p data-bbox="625 441 1421 493">The following errors can be configured and applied depending upon which mode the Supply Unit is operating. The errors will be triggered if the limit is</p> <p data-bbox="625 535 1437 598">exceeded for approximately 5 seconds. Press the  soft key to enter Edit mode prior to changing screens.</p> <p data-bbox="625 640 1469 819">Pressure Mode  : The specified error type (alarm [shutdown], deviation [warn], or none) will be triggered if the pressure is outside of the set-point pressure +/- tolerance range for approximately 5 seconds. For example: With a 5% tolerance, the pressure must be within 95 - 105% of the target pressure. If the pressure was outside of this range for 5 seconds or longer, an error could be triggered.</p> <p data-bbox="625 861 1469 976">Flow Mode  : The specified error type (alarm [shutdown], deviation [warn], or none) will be triggered if the flow rate is outside of the set-point flow +/- tolerance range for approximately 5 seconds. For example: With a 10% tolerance, the flow rate must be within 90 - 110% of the target flow rate.</p> <p data-bbox="625 997 1437 1050">Tolerances have a range of 0 - 99% (0 disables the error). Tolerance is set to 0% and “None” by default.</p> <p data-bbox="625 1092 1453 1239">Pump Diving Sensitivity  : The specified error type (alarm [shutdown], deviation [warn], or none) will be triggered if pump diving is detected. The sensitivity value ranges from 0 – 99 with 99 being extremely sensitive to pump diving. Set the pump diving sensitivity lower if an unusual number of pump diving errors are generated.</p> <p data-bbox="625 1260 1307 1281">Pump Type: Select the type of pump lower from the drop down.</p> <p data-bbox="625 1302 1242 1323">Pump Volume: Enter the volume of the pump lower in cc.</p> <p data-bbox="625 1344 1469 1417">Pressure Transducer Type: Select this box if a flush-mount pressure transducer is installed. If a standard issue pressure transducer is installed, leave the box unchecked.</p> <p data-bbox="625 1438 1469 1522">Pressure Transducer Offsets: Allows for the outlet transducers to be zeroed out. In edit mode, the soft key appears and automatically zeros out the readings +/- 145 psi (10 bar, 0.1 MPa) only.</p> <p data-bbox="625 1554 1421 1669">Pressure transducers are calibrated at the factory, but calibration may be necessary after extended use. Ideally, the pressure transducers should be removed, clear of any material, and in air when attempting calibration. Any residual pressure can throw off the calibration.</p> <p data-bbox="625 1711 1469 1921">Pressing the  soft key will automatically set the offsets to the negative of the value being read by the pressure transducers. The offsets can also be set manually by selecting “+” or “-” from the Offset drop down boxes and then entering the appropriate offset pressure rating. This can be used to adjust the pressure transducer to a non-zero value. For example, if the outlet pressure is known to be 1000 psi, but the transducer is reading 1010 psi. The offset can be set to -10 and the reading will be adjusted to show 1000 psi instead of 1010 psi.</p>

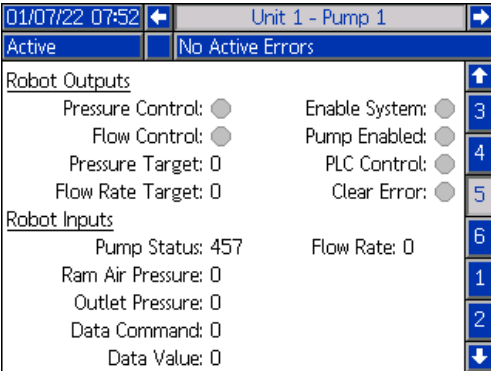
Screen	Description
	<p>Pump Setup Screen 2 – Maintenance and Pump Position</p> <p>This screen shows the number of cycles and maintenance limit for the driver, pump, and drum change. An advisory event will notify the user/robot that maintenance is due when the number of cycles exceeds the limit. This could be used for tracking oil or gear life.</p> <p>Setting the limit to zero disables the specific maintenance reminder.</p>
	<p>Pump Setup Screen 3 – Driver Calibration and Usage Histogram</p> <p>This screen shows the driver calibration status and the driver usage histogram.</p> <p>A  denotes the driver is calibrated and ready to operate. A  means the driver must be calibrated before operation. If the  icon appears next to calibration status, the driver must be calibrated. In edit mode, press the  soft key. See your driver manual for calibration instructions. Pressing  will begin calibration.</p> <p>The histogram shows the driver cycles in several bins of output force as a percentage of maximum force. This visualizes how hard the driver has been run in its lifetime. Cycles in bins toward the 100% end of the horizontal axis denote cycles that occurred when the output force of the driver was high.</p> <p>Pressing the  soft key switches between a histogram displaying the total lifetime cycles and the cycles since last reset. When in edit mode, pressing the  soft key on the right resets the histogram.</p>
	<p>Pump Setup Screen 4 - Diagnostic</p> <p>The diagnostic screen displays the values of key parameters that can be useful in troubleshooting issues.</p> <p>Pressure Set-point: Percentage of target driver thrust.</p> <p>Pressure Feedback: Percentage of actual driver thrust.</p> <p>Motor Temperature: This is the temperature of the motor. If this value is too high, it will generate an alarm and shut down the pump.</p> <p>IGBT Temperature: This is the temperature inside the driver casing on the control board. If this value is too high, it will generate an alarm and shut down the pump.</p> <p>Bus Voltage: This is the DC voltage of the driver bus.</p>

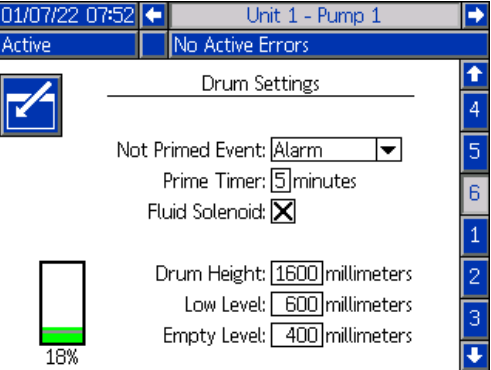
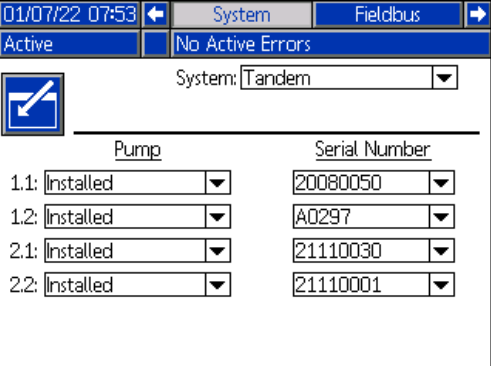
Screen	Description
	<p>Pump Setup Screen 5 – Automation Inputs/Outputs</p> <p>NOTE: This screen will only appear on Pump 1 of the Supply Unit, because Pump 1 controls fieldbus communication.</p> <p>This screen shows automation inputs/outputs.</p> <p>The robot outputs section shows the commands that can be sent by the robot. The  icon means the robot has not sent that specific command. The  icon means the robot has sent the command.</p> <p>The robot inputs section shows the values that are being sent from the pump to the robot. This can be used for troubleshooting to identify what the robot is seeing.</p>
	<p>Pump Setup Screen 6 – Drum Settings</p> <p>NOTE: This screen will only appear on Pump 1 of the Supply Unit, because Pump 1 controls the drum settings.</p> <p>Must be in edit mode to change any of the settings.</p> <p>Not Primed Event: The specified error type (alarm [shutdown], deviation [warn], or none) is triggered when a drum is replaced and the pumps have not yet been primed. If alarm is selected, the pumps must be primed after replacing a drum before returning to normal operation.</p> <p>Prime Timer: Enter the length of the pumps priming. Between 1 - 9 minutes.</p> <p>Empty Level: Enter the limit that must be reached before the empty level error is generated. Once the level is below the setpoint, an empty level error will be displayed.</p> <p>Low Level: Enter the limit that must be reached before the low level error is generated. Once the level is below the setpoint, a low level error will be displayed.</p> <p>Fluid Solenoid: Enables/disables additional features that require a fluid solenoid. The fluid solenoid must be installed to function properly.</p> <p>Drum Height: Enter the height of the drum. This parameter provides the Supply Unit with the height of the drum, allowing the system to know when the platen is not in the drum.</p>
	<p>System Setup Screen – Tandem Systems</p> <p>System: Select which type of system (ram or tandem) to configure.</p> <p>You must configure two different pumps and select the zone to which they are configured. The serial number for each pump will be listed as the serial number printed on the driver ID tag. By default, the pumps will configure themselves in ascending alphanumeric order based on the serial number. As a backup to the driver serial number, the serial number of the control board will be displayed instead. The serial numbers for the control boards are also displayed in the detailed software status screens.</p>

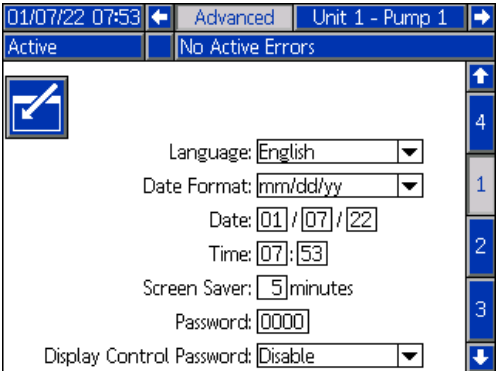
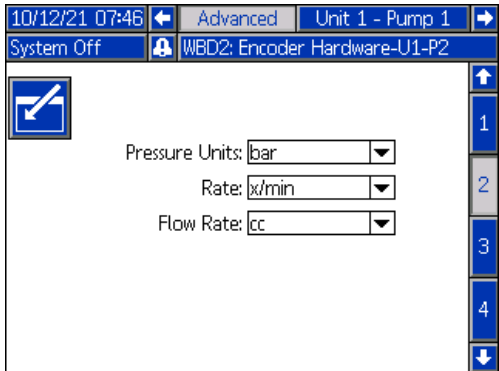
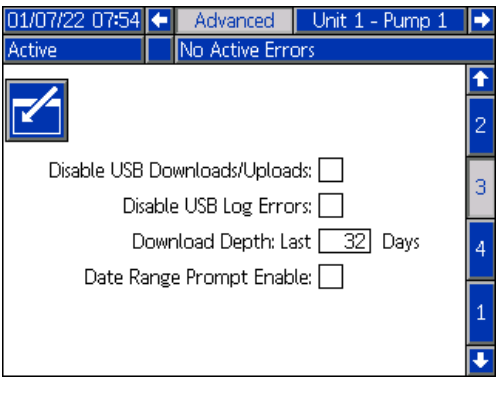
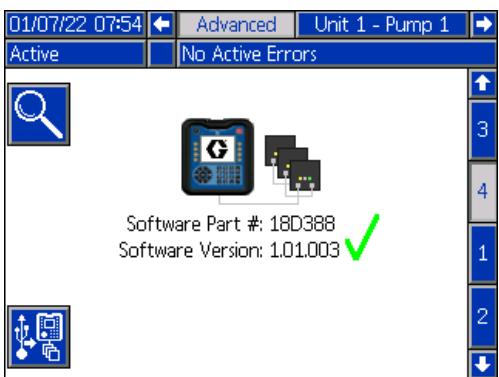
Screen	Description
 <p>The screenshot shows the 'Advanced Setup Screen 1 - Standard ADM Settings'. At the top, it displays the date and time '01/07/22 07:53', the menu 'Advanced', and the unit 'Unit 1 - Pump 1'. Below this, there are status indicators for 'Active' and 'No Active Errors'. The main area contains several settings: Language (English), Date Format (mm/dd/yy), Date (01/07/22), Time (07:53), Screen Saver (5 minutes), Password (0000), and Display Control Password (Disable). A vertical navigation bar on the right has buttons 1 through 4.</p>	<p>Advanced Setup Screen 1 – Standard ADM Settings</p> <p>Set the language, date format, date, time, screen saver time, and password in edit mode as necessary.</p> <p>Set “Display Control Password” to enable while a password is also set, to prevent switching into local/display control mode without first entering a password.</p> <p>Setting the password to “0000” disables the password feature.</p>
 <p>The screenshot shows the 'Advanced Setup Screen 2 - Unit Settings'. It displays the date and time '10/12/21 07:46', the menu 'Advanced', and the unit 'Unit 1 - Pump 1'. Below this, there are status indicators for 'System Off' and 'WBD2: Encoder Hardware-U1-P2'. The main area contains three settings: Pressure Units (bar), Rate (x/min), and Flow Rate (cc). A vertical navigation bar on the right has buttons 1 through 4.</p>	<p>Advanced Setup Screen 2 – Unit Settings</p> <p>Must be in edit mode to change unit settings.</p> <p>Pressure units: Choose between psi, bar, and MPa.</p> <p>Rate units: Choose between rates of x/min and x/sec.</p> <p>Flow Rate units: Choose between cc, gal(US), gal(UK), oz(US), oz(UK), liters.</p>
 <p>The screenshot shows the 'Advanced Setup Screen 3 - USB Log Settings'. It displays the date and time '01/07/22 07:54', the menu 'Advanced', and the unit 'Unit 1 - Pump 1'. Below this, there are status indicators for 'Active' and 'No Active Errors'. The main area contains four settings: Disable USB Downloads/Uploads (checkbox), Disable USB Log Errors (checkbox), Download Depth: Last (32 Days), and Date Range Prompt Enable (checkbox). A vertical navigation bar on the right has buttons 1 through 4.</p>	<p>Advanced Setup Screen 3 – USB Log Settings</p> <p>Must be in edit mode to change USB log settings.</p> <p>Disable USB Downloads/Uploads: Enables/disables option to disable automatic USB downloads/uploads upon insertion of a USB drive.</p> <p>Disable USB Log Errors: Enables/disables option to disable any USB log errors from appearing on the ADM.</p> <p>Download Depth: Enter the number of days included in USB data log downloads. USB data is overwritten when the logs fill.</p> <p>Date Range Prompt Enable: Enables/disables option to be prompted a time frame to download data from when the USB download is enabled and a USB drive is inserted.</p>
 <p>The screenshot shows the 'Advanced Setup Screen 4 - Software'. It displays the date and time '01/07/22 07:54', the menu 'Advanced', and the unit 'Unit 1 - Pump 1'. Below this, there are status indicators for 'Active' and 'No Active Errors'. The main area shows a software icon and the text 'Software Part #: 18D388' and 'Software Version: 1.01.003' with a green checkmark. A vertical navigation bar on the right has buttons 1 through 4.</p>	<p>Advanced Setup Screen 4 – Software</p> <p>This screen can be used to view the version of software used in the system. Additionally, this screen is used to update the system software using a USB drive with the latest software and a Graco black token.</p> <p>See Graco ADM Token In-System Programming manual for a detailed description of this screen.</p>

Changing Empty Drums

NOTE: If using a tandem system, after the automatic Pump crossover has taken place, immediately replace the empty drum with a new, full drum. If both UniDrums become empty at the same time:

- Material will stop being delivered to the dispenser.
- Air may enter the supply hose or pipe header.

Drum Changing Procedure

To remove an empty drum and load a new, full drum:

1. If used, verify that the two front and rear Drum Clamps (N) are engaged on the UniDrum ram base. Drum Clamps (N) are used on 300 gallon Supply Units only.
2. Check that the Pumps On/Off Switch (AF) is turned to the OFF position. An alarm will display on the ADM to let the user know that the pumps are off.
3. Check that the Ram Up Air Regulator (AA) is set to 50 psi. It is not recommended to exceed 80 psi.
4. Close the two Ball Valves (M) at the outlet manifold at the rear of the UniDrums.
5. To raise the Follower Plate (D), set the Ram Position Switch (AG) to UP.
6. Simultaneously push and hold both Ram Actuation Buttons (AI). If the drum lifts, release the actuation buttons and press the Follower Plate Blowoff Button (AJ) to add more air to the drum. Repeat step 6.
7. With the ram raised and the Ram Position Switch (AG) set to RAISE, pull the Drum Clamps (N) (if used) back and remove the empty drum using a suitable lifting device.

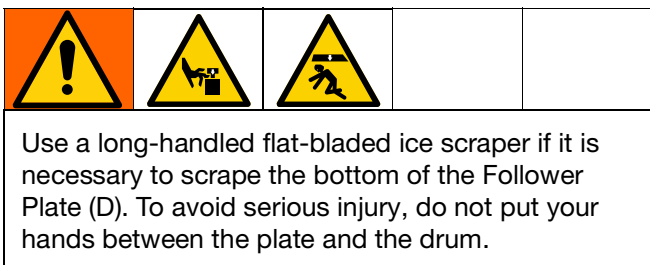

8. Being careful not to damage the Follower Plate (D) wipers, wipe or scrape any material buildup from the Follower Plate (D) and wipers, and properly dispose of the waste material.

Load Material

NOTICE

When opening a new drum, take care to remove the cover by holding it level. Tipping the cover may allow accumulated dirt to spill into the material, which can damage the equipment. Also check that the drum is not damaged or dented.

1. Remove the cover from the new drum and remove any other packaging from the drum, exposing the material. Make sure there are no foreign objects on the surface of the material.
2. Position the new drum, using a suitable lifting device, under the raised Follower Plate (D).
3. It is extremely important to lubricate the Follower Plate wiper with a lubricant that is compatible with the material to be pumped. Check with your material supplier for compatibility.
4. If used, push the front and rear Drum Clamps (N) forward until engaged. Making sure the nut is unscrewed and touching the base of the knob, twist the knob clockwise until the screw makes contact with the drum base. Tighten the nut.

NOTE: Drum Clamps (N) are only used on 300 gallon systems.

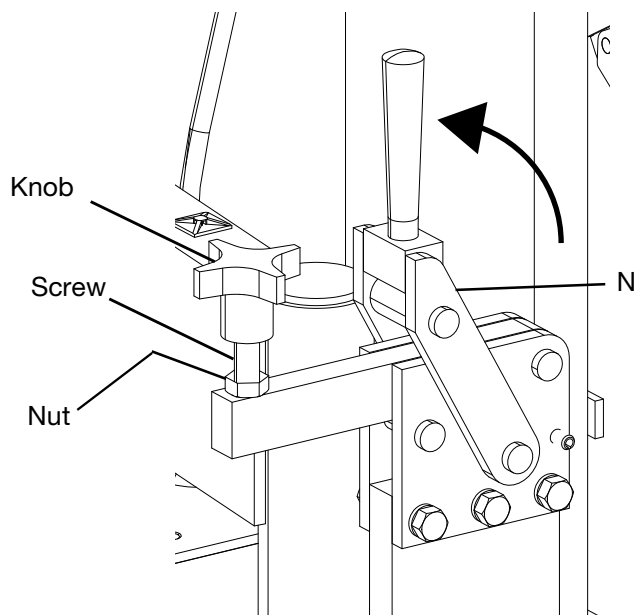

FIG. 21



To reduce the risk of serious bodily injury, such as splashing fluid in the eyes or on the skin, always wear eye protection and protective clothing when operating this equipment.

The pressure relieved by removing the bleed sticks may cause the Follower Plate (D) to lower unexpectedly. To prevent personal injury from moving parts, such as pinching or amputating hands or fingers, keep hands and fingers away from the Follower Plate (D) when removing the bleed sticks.

5. Remove the bleed sticks from the Follower Plate (D).



To prevent injury from moving parts, make sure that nothing is between the Follower Plate (D) and the drum before lowering the Follower Plate into the drum.

6. Lower the Follower Plate (D) as follows:
 - a. Set the Ram Position Switch (AG) to DOWN.
 - b. Lower the Follower Plate (D) until the material is evident in the Bleed Ports (K).
 - c. Set the Ram Position Switch (AG) to HOLD/NEUTRAL.
 - d. Replace the bleedsticks.
 - e. Set the Ram Position Switch (AG) to DOWN.
7. Close both Pump No. 1 and Pump No. 2 outlet Ball Valves (M).

8. Press the ADM Startup button  to turn on the ADM.

Priming

Preventing Pump Cavitation

NOTE: Cavitation occurs when the Pump cylinder did not fully load with material on the upstroke, and a cavity forms in the material after the Pump changes to the downstroke.

1. To prevent cavitation from occurring, perform the following steps:
 - a. Press the PRIME PUMP Pushbutton  to prime the Pumps and fill the material passages. See **Running the System** on page 45.
 - b. Increase the ram down pressure.
2. Use a catch device to bleed the Pump. Slowly twist open the Pump bleed valve on the Pump that will be serviced. Do not remove the pump bleed valve.

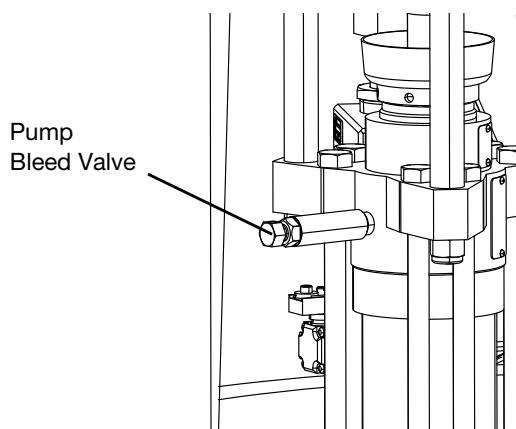

FIG. 22

NOTE: If the Pump does not prime properly, which may occur with heavier, high viscosity fluids, increase the air pressure with the Ram Down Air Regulator (AC).

NOTE: If fluid is forced out around the top wiper, ram pressure is too high; decrease the air pressure with the Ram Down Air Regulator (AC).

NOTE: Ram pressure adjustments are carried out using the dual Regulator control knobs (AA, AC) on the Control Box (F).

3. Open the Ball Valve (M) on the outlet manifold from Pump No. 1 and 2.
4. Remove the waste containers, clean up any spilled material, and dispose of the waste material properly.

Operation

5. Check there are no alarms present on the ADM.

Running the System

1. Open the Main Air Shutoff Valve (J) to the Supply Unit (see FIG. 23).

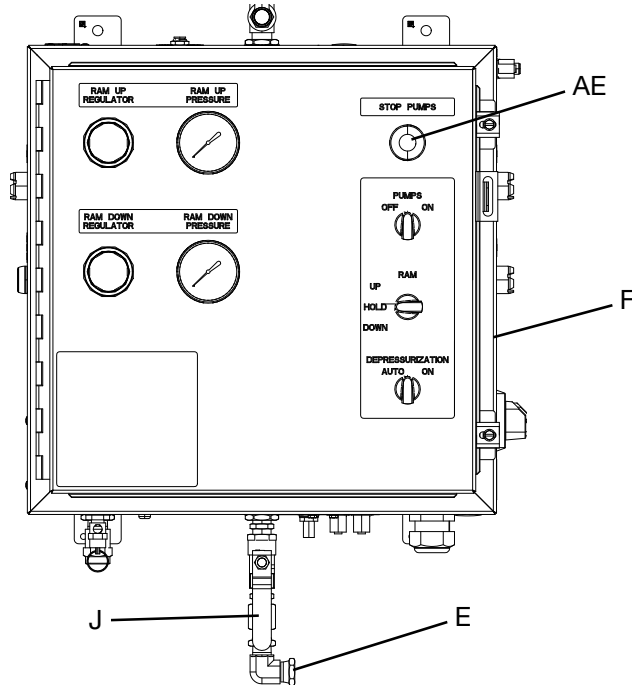





FIG. 23

2. Press the Startup button  on the ADM. See **ADM Keys and Indicators** on page 17.
3. Twist the Stop Pumps Button (AE) on the Control Box (F) to clear the supply system stop.
4. Acknowledge all errors.
5. Press the green Start Pump icon  to begin pumping material.

Stopping the System

To stop the Dura-Flo Pumps with Electric Motors (C)

during operation, press the inverted red soft key  on the ADM. See **ADM Soft Keys** on page 22. If using a tandem system, pressing the inverted red soft key on one Supply Unit will stop the Dura-Flo Pumps with Electric Motors (C) on that particular Unit, and the system will automatically crossover to the other Supply Unit. See FIG. 3 on page 13.

Light Tower Color Codes

Color	Description
Green	No errors
Yellow	An advisory exists
Yellow flashing	A deviation exists
Red solid	An alarm exists.

Pressure Relief Procedures

These procedures describe how to relieve pressure from the system.



Follow the Pressure Relief Procedure whenever you see this symbol.

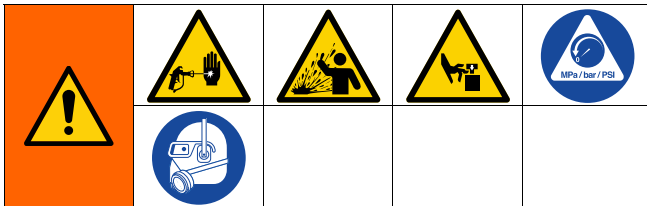

This equipment stays pressurized until pressure is manually relieved. To help prevent serious injury from pressurized fluid, such as skin injection, splashing fluid and moving parts, follow the Pressure Relief Procedure when you stop spraying and before cleaning, checking, or servicing the equipment.

Fluid Pressure Relief Procedure

This procedure describes how to relieve pressure on the Follower Plate (D) and in the Pumps (C). Use this procedure whenever you shutoff the Pumps and before checking or adjusting any part of the system.

If using a tandem system, perform the following steps on each Supply Unit:

1. Press the ADM Stop key .
2. Turn the Depressurization Switch (AH) to ON, or press the depressurization button on the ADM. See **Pump Run Screen (Ram) in Edit Mode** on page 35.
3. Verify the pressure is at 0 psi on the Pump Run Screen (Ram) on the ADM. After the pressure is relieved from the Follower Plate (D), raise the Follower Plate by setting the Ram Position Switch (AG) to the UP position.

NOTE: In order to fully relieve system pressure, including ram cylinders, the steps in the **Pneumatic Pressure Relief Procedure** on page 47 must be performed.

Pneumatic Pressure Relief Procedure

This procedure describes how to relieve pressure on the Control Box (F) and cylinders. Use this procedure whenever you perform ram assembly service on the piston rod seal or the ram piston. If using a tandem system, follow these steps on each Supply Unit.

1. Follow **Fluid Pressure Relief Procedure** on page 46.
2. Fully lower the ram by setting the Ram Position Switch (AG) to DOWN and pressing the Ram Actuation Buttons (AI). Leave the switch in the DOWN position.
3. Adjust the Ram Down Air Regulator (AC) to 0 psi. Refer to the Ram Down Air Pressure Gauge (AD) and R3 Regulator (AO) to verify the ram has been depressurized. See FIG. 25.
4. Slowly open the drain cock located on the bottom of each air cylinder (CL).
5. After the air pressure has been relieved, remove the incoming air supply from the Supply Unit.
6. Close the Main Air Shutoff Valve (J).
7. Leave the drain cock open and the incoming air supply line removed until service is complete.
8. After service is complete, close drain cocks, make all pneumatic connections, and open the Main Air Shutoff Valve (J). Perform the **Adjusting the Ram Up and Ram Down Air Regulators** procedure, page 32.

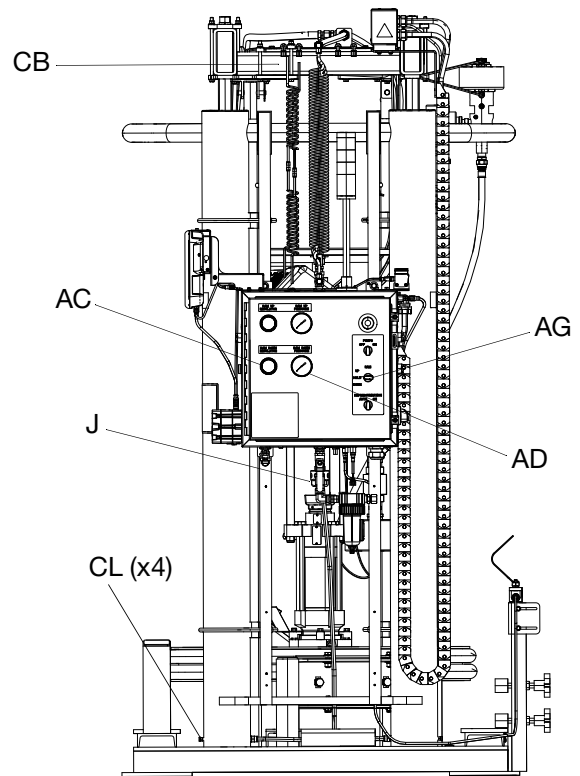

FIG. 24

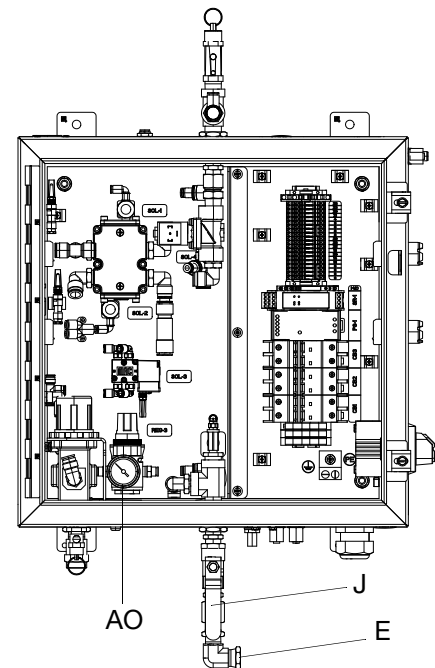

FIG. 25

Maintenance

Preventative Maintenance Schedule

The operating conditions of your particular system determine how often maintenance is required. Establish a preventive maintenance schedule by recording when and what kind of maintenance is needed, and then determine a regular schedule for checking your system. See **Pump Setup Screen 2 – Maintenance and Pump Position** on page 39 for more information on setting up maintenance counters.

Flushing the System

Flush the Pump:

- Before the first use
- When changing material or fluid part number or brand
- Before fluid can dry or settle out in a dormant Pump (check the shelf life or pot life of catalyzed fluids)
- Before storing the Pump.

Flush with a fluid that is compatible with the fluid you are pumping and with the wetted parts in your system. Check with your fluid manufacturer or supplier for recommended flushing fluids and flushing frequency.

				
<p>To avoid fire and explosion, always ground equipment and waste container. To avoid static sparking and injury from splashing, always flush at the lowest possible pressure.</p>				

To flush the system, perform the following procedure:

1. Place a drum of compatible flush material under the Follower Plate (D).
2. Run the Pumps to move the flush material through the system for approximately 1 to 2 minutes or until the solution is clean.
3. Remove the drum containing the flush material from under the Follower Plate (D).
4. Return the system to previous operation settings.

Cleaning the System

NOTICE
<p>Cleaning the system after using it can prevent material contamination, which may cause the material to fail or perform poorly. Do not load new material into a contaminated system.</p> <p>Clean the system to avoid untimely equipment malfunctions and to ensure that system components operate efficiently</p>

To clean the system, perform the following procedure:

1. Turn the Ram Position Switch (AG) to UP, then simultaneously press both Ram Actuation Buttons (AI) to move the ram to the fully raised position.
2. To lock the ram in the fully raised position, move the Ram Position Switch to the HOLD/NEUTRAL position and insert both safety hitch pins (1306) into the outer support bars (1302) and install both pin lock clips.

NOTE: Locks that use 1/4 in. shackles can be used in place of the cotter pins (CP) provided with the safety hitch pins (1306).

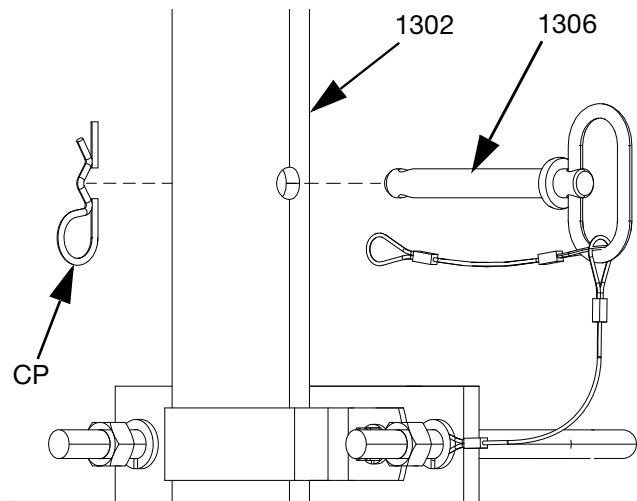
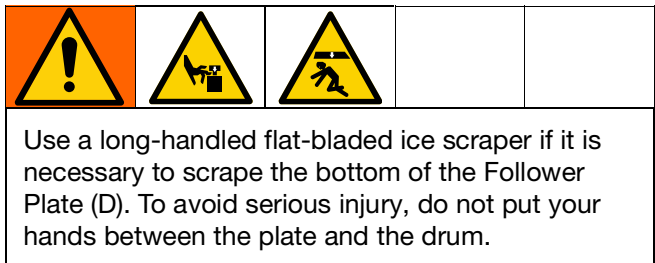

FIG. 26

3. Once both safety hitch pins (1306) are secured, turn off all air to the system by closing the Main Air Shutoff Valve on the header (J) and follow your facility's pre-established lock-out/tag-out procedures. See FIG. 24 on page 47.

- It is recommended to clean the platen between each drum change, or as recommended by your facility's maintenance plan.



- Being careful not to damage the Follower Plate (D) wipers, wipe or scrape any material buildup from the Follower Plate (D) and wipers, and properly dispose of the waste material.
- Apply a generous amount of lubricant to the Follower Plate (D) wipers.

NOTICE

The use of a non-compatible lubricant can cause material contamination or inadequate performance. Use only a lubricant compatible with the material to be pumped. Check with the material supplier for a recommended lubricant.

To help avoid damage to equipment, do not use a drum of material that has been dented or otherwise damaged; damage to the Follower Plate wiper may result.

- To place the ram back into operation, verify the Ram Position Switch (AG) is still in the HOLD/NEUTRAL position, and open the Main Air Shutoff Valve on the header (J).
- Turn the Ram Position Switch (AG) to RAISE, then simultaneously press both Actuation Pushbuttons (AF) to move the ram to the fully raised position.
- Remove both safety hitch pins (1306).
- Return the system to previous operation settings.

Wiper Lubrication

It is extremely important that the Follower Plate (D) wipers be thoroughly lubricated between drum changes. The Follower Plate (D) may stick without lubrication.

Ram Assembly Service

Piston Rod Seal Service

1. Relieve the air pressure. Follow the **Pneumatic Pressure Relief Procedure** on page 47.
2. Remove the four nuts and lockwashers holding the tie bar to the rods. Remove the tie bar.
3. Remove the guide sleeve retaining ring by gripping the ring tab with a pair of pliers and rotating the ring out of its groove.
4. Remove the guide sleeve by sliding it off of the rod. Four 1/4 in. -20 holes are provided to ease removal of the guide sleeve.



Do not use pressurized air to remove the guide sleeve or piston. Failure to follow this instruction may result in personal injury.

5. Inspect the parts for wear or damage. Replace as necessary.
6. Install new O-rings and seal guard. Lubricate the packings with O-ring lubricant.
7. Slide the guide sleeve onto the rod and push it into the cylinder. Replace the retaining ring by feeding it around the guide sleeve groove.
8. Reinstall the tie bar using the nuts and lockwashers. Torque to 40 ft-lb (54 N•m).

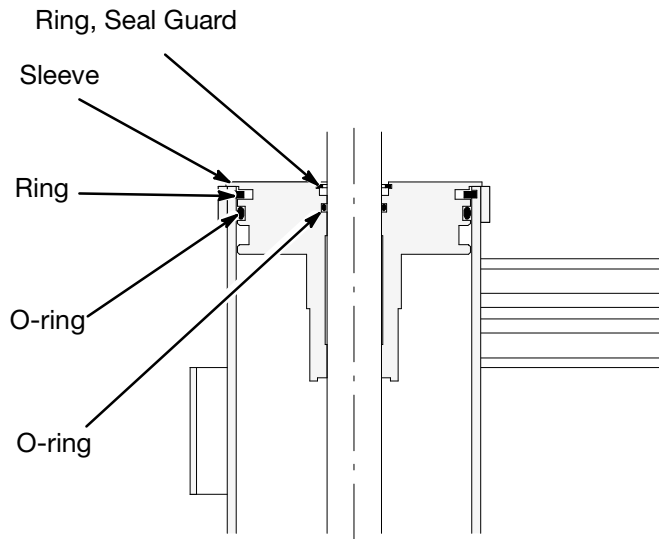

Refer to Repair Kit 918110.

7056A

FIG. 27

Ram Piston Service

1. Relieve the air pressure. Follow the **Pneumatic Pressure Relief Procedure** on page 47.
2. Remove the tie bar as explained in the **Piston Rod Seal Service** section on page 50.
3. Remove the guide sleeve and slide it off of the piston rod.



Do not use pressurized air to remove the guide sleeve or piston. Failure to follow this instruction may result in personal injury.

4. Carefully pull the piston rod straight up out of the cylinder. If the rod is cocked to one side, the piston or inside surfaces of the cylinder could be damaged.
5. Carefully lay the piston and rod down so the rod will not be damaged or bent. Remove the lower piston retaining ring. Slide the piston off the piston rod.
6. Install new O-ring seals on the piston rod and the piston. Lubricate the piston and seals. Reinstall the piston and retaining ring.
7. Carefully insert the piston into the cylinder and push the rod straight down into the cylinder. Add 3 ounces of lubricant to each cylinder after inserting the piston.
8. Slide the guide sleeve onto the piston rod. Reinstall the retaining ring and tie bar, as explained under **Piston Rod Seal Service** section on page 50.

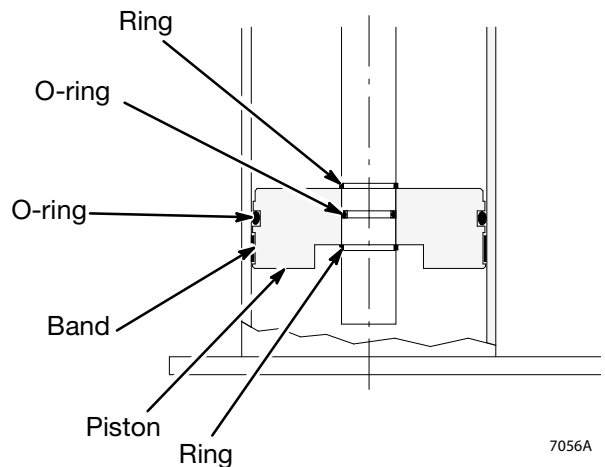

FIG. 28

Depressurization Valve (Ball Seat Applicator) Repair Procedure

Refer to instruction manual 3A1792 for the ball seat applicator (V1M350) service procedures and parts information.

Servicing the Pumps

When the Pumps and electric motors require service, refer to the applicable instruction manual for detailed information. See **Related Manuals** on page 3.

Replacing Wipers

1. Perform the **Fluid Pressure Relief Procedure** on page 46.
2. Follow steps 1-5 for **Cleaning the System** on page 48.
3. To replace worn or damaged wipers (412), raise the Follower Plate (D) up out of the drum. Remove the drum from the base. Wipe the fluid off the Follower Plate (D).



Use a long-handled flat-bladed ice scraper if it is necessary to scrape the bottom of the Follower Plate (D). To avoid serious injury, do not put your hands between the plate and the drum.

4. Separate the wiper joint (WJ) and bend back the strapping (413a) covering the clamp setscrew (413c). See Detail A of FIG. 29. Loosen the setscrew, pull the end of the strapping through the clamp (413b) and remove the wiper.
5. Slide the strapping (413a) through the new wiper (412). Slide the clamp (413b) onto the new strapping and bend the strapping back approximately 3 in. (76 mm). Insert the strapping through the clamp a second time. See Detail B of FIG. 29.
6. Install the wipers on the Follower Plate (D). Position the wipers so that the wiper joints (WJ) are 180° apart.

NOTE: You will need the special banding tool (BT) shown in Detail C of FIG. 29 to tighten the strapping. Order Part No. 168092 Banding Tool.

7. Grip the strapping (413a) with the bonding tool (BT) as shown. With your thumb on the gripper lever (GL), turn the tool handle (TH) clockwise to apply tension.

NOTE: Be careful not to pull the cutting handle (CH) until you are ready to cut the strapping in step 8.

8. Continue turning the tool handle until you see the strapping stop moving through the clamp (413b). Stop turning the handle.
9. Tighten the setscrew with a wrench (W). Pull the cutting handle (CH) to cut. Remove the bonding tool (BT). Bend the strapping back over the clamp (413b).
10. Pound the wiper all the way around with a rubber mallet until the wiper joints (WJ) are butted tightly together.
11. Follow steps 6-9 for **Cleaning the System** on page 48.
12. Return the system to previous operation settings. Refer to the **Load Material** procedure on page 42.

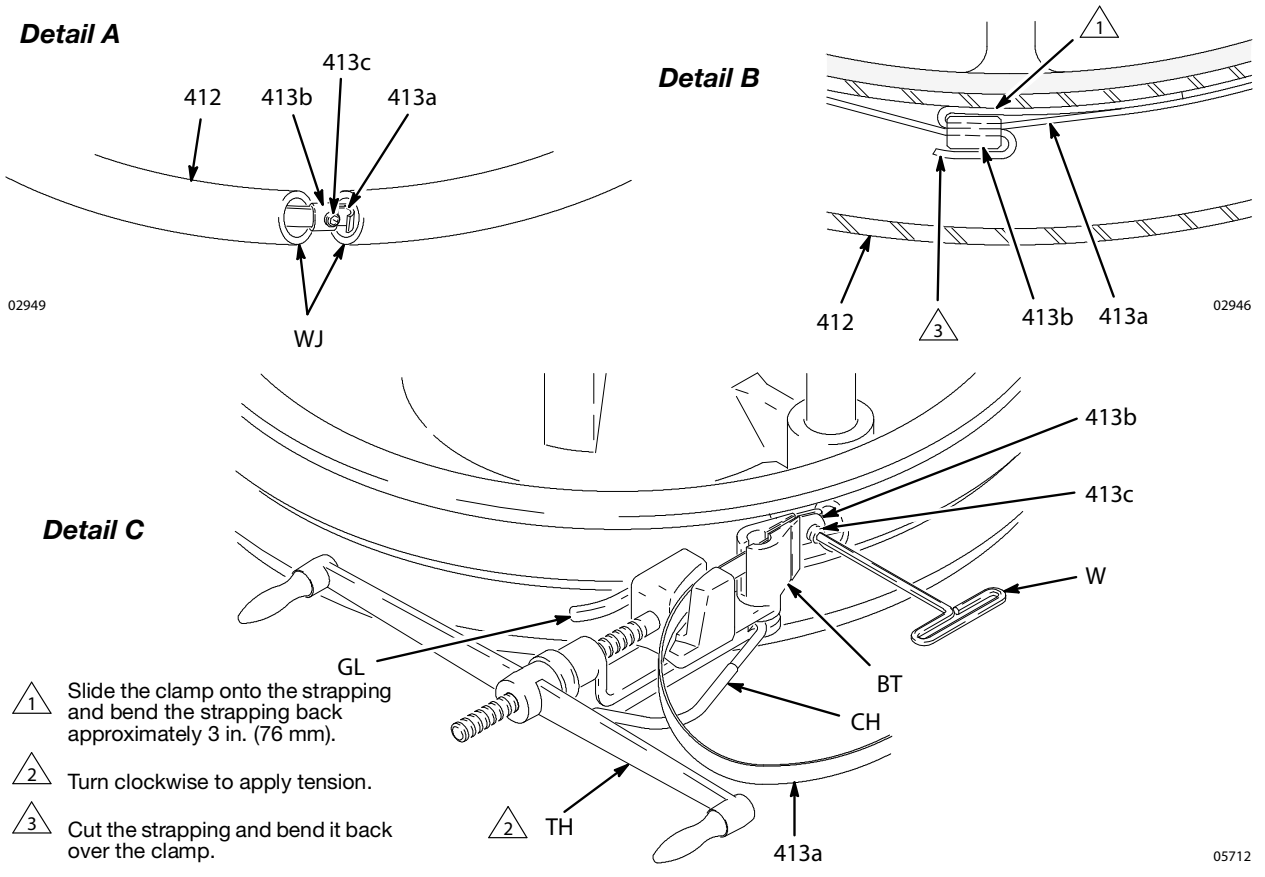





FIG. 29

Pump Removal

NOTE: See **Parts** on page 56. For pump service, see your related pump manual. See **Related Manuals** on page 3.

				
To prevent serious injury from moving parts, make sure to fully lower the ram before removing the Pump.				

1. Follow the **Fluid Pressure Relief Procedure** on page 46.
2. Disconnect electrical power from the system. Turn the System Disconnect Switch (AL) OFF.
3. Move the Ram Position Switch (AG) to HOLD/NEUTRAL.
4. Close the Pump outlet Ball Valves (M) and twist open the pump bleed valve on the pump that will be serviced. See the appropriate related manual for the proper location and procedure for the pump installed. See **Related Manuals** on page 3.
5. Using an overhead lifting device, attach and secure a chain capable of lifting the weight of the Pump assembly to the lift ring at the top of the electric motor.

NOTE: For effective Pump removal, the lifting point must be directly above the Pump and capable of moving sideways. The lifting action should be the “chain fall” type that allows a slow upward and downward movement.

NOTE: Check the **Technical Specifications** in the separate Pump manual to find the weight of the Pump being serviced. For example, a 430cc Dura-Flo pump weighs 215 lb (97.5 kg) per the E-Flo SP Electric Pumps manual.

6. Detach the electrical cord from the electric motor and all other connection on the APD20 driver.
7. Detach the fluid supply hose at the Pump outlet.

NOTE: When loosening the Pump and the electric motor fasteners in the following steps, ensure the chain slack is taken up to prevent the Pump assembly from falling.

8. On the Follower Plate adapter, loosen and rotate or remove four lugs and hex bolts holding the flange of the Pump lower.

9. On the underside of the electric motor, remove the bolts securing the electric motor to the motor support brackets. It may be necessary to move or remove some brackets for effective Pump removal.

NOTE: When lifting the Pump in steps below, ensure the lifting chain does not damage the air controls mounted at the top of the ram cross-members.

10. Using a “chain fall” style lifting device, slowly pull the Pump upward a few inches until the base of the Pump clears the Pump mounting adapter and the electric motor clears the support brackets.
11. Pull the Pump assembly out of the ram assembly and guide the Pump assembly downward to the floor, placing the base of the Pump on a wood surface and taking care not to damage the seal area of the Pump inlet housing.
12. Remove the gasket and o-ring (32, 33) from the Pump adapter. They should be discarded and replaced when the Pump is reinstalled.
13. Clean excess and hardened material from the Pump adapter on the Follower Plate (D).
14. Ensure that material is not rising through the Pump adapter in the Follower Plate (D). If material is flowing upward, move the Ram Position Switch (AG) to RAISE until the flow stops, then move the switch back to HOLD/NEUTRAL.
15. Move the Pump assembly to a suitable work area and repair the Pump using the appropriate Graco Instruction Manual. See **Related Manuals** on page 3.

Pump Installation

1. When the Pump is serviced and tested and ready to be replaced in the UniDrum ram assembly, perform the steps of the **Pump Removal** procedure in reverse order.
2. It is recommended that the Pump be tagged with the type and date of repair and the name of the technician who performed the repair.
3. Before returning the reassembled Pump to production use, it must be primed with material and air removed from the material. See the Starting and Adjusting the Pump section in your appropriate Pump Instruction manual shown in **Related Manuals** on page 3.

Recycling and Disposal

End of Product Life

At the end of the product's useful life, dismantle and recycle it in a responsible manner.

- Perform the **Pressure Relief Procedures**.
- Drain and dispose of fluids according to applicable regulations. Refer to the material manufacturer's Safety Data Sheet.
- Remove motors, batteries, circuit boards, LCDs (liquid crystal displays), and other electronic components. Recycle according to applicable regulations.
- Do not dispose of batteries or electronic components with household or commercial waste.



- Deliver remaining product to a recycling facility.

Troubleshooting

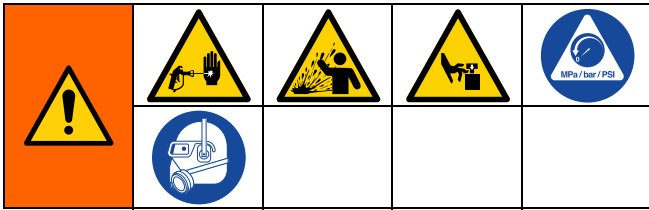

1. Turn OFF the System Disconnect Switch (AL) and follow **Pressure Relief Procedures**, page 46 and 47, before checking or repairing the E-Flo UniDrum Supply System.

Ram Assembly Troubleshooting

Problem	Cause	Solution
Ram won't raise or lower	Not pressing the actuation buttons simultaneously	Choose UP/DOWN Press the actuation buttons simultaneously.
	Closed Main Air Shutoff Valve (J) or clogged air line	Open air valve, clear air line
	Not enough air pressure	Increase ram UP or DOWN pressure
	Worn or damaged piston	Replace piston. See Ram Piston Service on page 51.
	Safety Pins (H) still in place	Remove pins.
	Bleed Port (K) is not open	Open Bleed Port (K).
	Material outlet valves are closed	Open the material outlet valve.
Ram raises or lowers too fast	Ram air pressure too high	Decrease ram air pressure
Fluid squeezes past Follower Plate wipers	Ram air pressure too high	Decrease ram air DOWN pressure
	Worn or damaged wipers	Replace wipers. See Replacing Wipers on page 52.
Pump won't prime properly, or pumps air	Not enough ram air pressure	Increase ram DOWN pressure
	Worn or damaged ram piston	Replace ram piston. See Ram Piston Service on page 51.
	Bent drum has stopped Follower Plate	Replace drum

Pump Troubleshooting

For additional information about the Pump lower, refer to **Related Manuals** on page 3 to find the applicable instruction manual.

Problem	Cause	Solution
Rapid downstroke or upstroke (pump cavitation)	Air is trapped in Pump.	Bleed air from the Pump using this procedure: <ol style="list-style-type: none"> 1. Place a waste container under the Bleed Port (K). 2. Press the PRIME PUMP Pushbutton  to turn on air to the Pump. 3. Allow material to flow from the Bleed Port until it is air-free. 4. Release the PRIME PUMP Pushbutton to turn off the Pump. Close the Bleed Port. 5. Return to normal operation.
	Downstroke: Lower check in Pump is worn. Upstroke: Upper check in Pump is worn.	Rebuild and replace Pump, as necessary.
Material leaks around Pump outlet	Outlet fitting is loose.	Tighten outlet fitting.
Material leaks around Bleed Port (K)	Bleed Port fitting is loose.	Tighten Bleed Port fitting.
Pump won't move up or down	Problem with electric motor.	See the APD20 Advanced Precision Driver Instructions manual.
	Foreign object lodged in Pump.	Remove object and rebuild Pump assembly.
Wet cup leaks	Worn throat packings.	Tighten wet cup. Replace throat packings.

Software Troubleshooting



REMOTE SYSTEM ACTIVATION HAZARD

To avoid injury due to remote machine operation, perform the steps below before troubleshooting. This will prevent commands sent from the fieldbus or display module from actuating the driver/pump.

On the Control Box (F), turn the Pumps On/Off Switch (AF) to the OFF position.

Error Codes and Troubleshooting

See **Troubleshoot Error Codes** table on page 60, or visit help.graco.com/en/supply-systems/e-flo-unidrum-syst-em for causes and solutions to each error code.

Errors

View Errors

When an error occurs, the error information screen displays the active error code and description.

The error code, alarm bell, and active errors will scroll in the status bar. Error codes are stored in the error log and displayed on the Error and Troubleshooting screens on the ADM.



FIG. 30

Alarms are indicated by . This condition indicates a parameter critical to the process has reached a level requiring the system to stop. The alarm needs to be addressed immediately.

Deviations are indicated by . This condition indicates a parameter critical to the process has reached a level requiring attention, but not sufficient enough to stop the system at this time.

Advisories are indicated by . This condition indicates a parameter that is not immediately critical to the process. The advisory needs attention to prevent more serious issues in the future.

Events Log Screen

This screen shows the date, time, event code, and description of all events that have occurred on the system. There are 20 pages, each holding 10 events. The 200 most recent events are shown.

See **Troubleshoot Errors** page 59, for instructions on viewing event code descriptions.

All events listed on this screen can be downloaded on a USB flash drive. To download logs, see the **Download Procedure** on page 69.

01/07/22 07:45		Tandem	Events	Errors
Active	No Active Errors			
Date	Time	Code	Description	
01/07/22	07:44	ECOX-R	Setup Values Changed	6
01/07/22	07:41	ECOX-R	Setup Values Changed	7
01/07/22	07:41	EBUX-V	Download to USB Complete	8
01/07/22	07:40	EAUX-V	Download to USB In Process	1
01/07/22	07:40	ELOX-R	Power On	2
01/07/22	07:40	EMOX-R	Power Off	3
01/07/22	07:39	EBUX-V	Download to USB Complete	4
01/07/22	07:39	EAUX-V	Download to USB In Process	
01/07/22	07:37	ELOX-R	Power On	
01/07/22	07:21	EMOX-R	Power Off	

FIG. 31

Errors Log Screen

This screen shows the date, time, error code, and description of all errors that have occurred on the system. The 200 most recent errors are shown.

See **Troubleshoot Errors** page 59, for instructions on viewing event code descriptions.

All errors listed on this screen can be downloaded on a USB flash drive. To download logs, see the **Download Procedure** on page 69.

01/07/22 07:46				Events	Errors	Troubleshooting
Active				No Active Errors		
Date	Time	Code	Description			
01/07/22	07:43	DD31-D	Pump Diving-U1-P1	18		
01/06/22	16:34	CBD4-A	Comm. Error-U2-P2	19		
01/06/22	16:34	CBD3-A	Comm. Error-U2-P1	20		
01/06/22	16:34	L2C1-D	Drum Low-U1-P1	1		
01/06/22	16:34	P6D1-D	Outlet Pressure Sensor-U1-P1	2		
01/06/22	16:34	WSC1-D	Encoder Calibration-U1-P1	3		
01/06/22	16:34	DEP1-A	Pumps Disabled-U1-P1	4		
01/06/22	16:34	L1C1-A	Drum Empty-U1-P1			
01/06/22	16:34	DKC1-A	Crossover Error-U1-P1			
01/06/22	16:34	WBD1-A	Encoder Hardware-U1-P1			

Fig. 32

Troubleshooting Screen

This screen displays the last ten errors that occurred on the system. Use the up and down arrows to select an

error and press  to view the QR code for the

selected error. Press  to access the QR code screen for an error code that is not listed on this screen.

See **Troubleshoot Error Codes** on page 60 for more information on error codes.





08/21/21 10:36		Troubleshooting	Tandem
System Off		L1C3: Drum Empty-P3	
	T2D4	Motor Temperature Sensor-P4	
	T2D3	Motor Temperature Sensor-P3	
	P6D1	Outlet Pressure Sensor-P1	
	WSC1	Encoder Calibration-P1	
	WBD1	Encoder Hardware-P1	
	P6D4	Outlet Pressure Sensor-P4	
	P6D3	Outlet Pressure Sensor-P3	
	P6D2	Outlet Pressure Sensor-P2	
	WSC4	Encoder Calibration-P4	
	WBD4	Encoder Hardware-P4	

Fig. 33

Troubleshoot Errors

To troubleshoot the error:

1. Press the soft key next to “Help With This Error” for help with the active error.

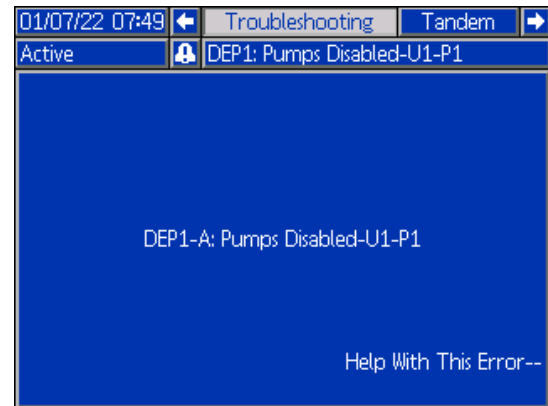



Fig. 34

NOTE: Press  to return to the previously displayed screen.

2. The QR code screen will be displayed. Scan the QR code with your smart phone to be sent directly to online troubleshooting for the active error code. You can also navigate to help.graco.com/en/supply-systems/e-flo-unidrum-system for causes and solutions to each error code.

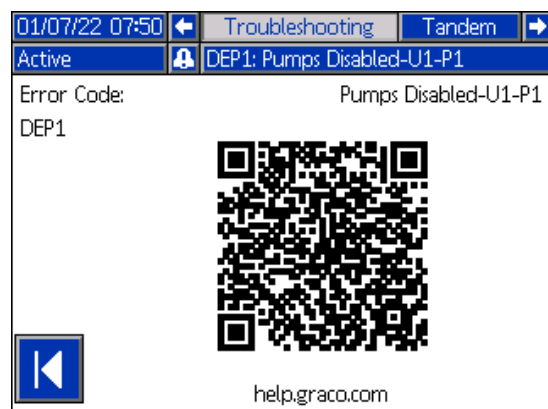

Fig. 35

3. If no internet connection is available and assistance is needed, call Graco Technical Assistance.

Troubleshoot Error Codes

Error	Location	Type	Error Name	Error Description	Cause	Solution
A4D_	Driver	Alarm	High Motor Current U_-P_	Motor current exceeds maximum allowed value	Software bug	Update software to the latest available on help.graco.com .
					Encoder malfunction	Replace encoders.
					Short circuit of motor wiring	Check wiring to the motor to ensure no bare wires are touching and that no wires are shorted to ground.
					Motor not able to rotate	Check that motor shaft rotates freely.
A4N_	Driver	Alarm	High Motor Current U_-P_	Motor current exceeds maximum allowed value	Software bug	Update software to the latest available on help.graco.com .
					Encoder malfunction	Replace encoders.
					Short circuit of motor wiring	Check wiring to the motor to ensure no bare wires are touching and that no wires are shorted to ground.
					Motor not able to rotate	Check that motor shaft rotates freely.

Error	Location	Type	Error Name	Error Description	Cause	Solution
CAC_	ADM	Alarm	Communication Error U_-P_	Communication lost between ADM and pump	No 24 VDC power supply to ADM	Reconnect or replace CAN cable connecting driver and ADM. If CAN connection good, check 24V power supply wiring in driver. Make sure AC power to pump is turned off before checking power supply. Yellow LED on driver connector board should be flashing.
					Cross threaded CAN cable.	CAN cables carry 24 V DC power and communication between modules. A cross threaded CAN cable connector may cause problems with communication and/or power to modules. Carefully check for cross threaded CAN connections on the ADM and driver. Yellow LED on driver connector board should be flashing.

Error	Location	Type	Error Name	Error Description	Cause	Solution
CAD_	ADM	Alarm	Driver Offline U_-P_	Communication between the ram two drivers	No 24 VDC power supply to ADM	Reconnect or replace CAN cable connecting driver and ADM. If CAN connection good, check 24V power supply wiring in driver. Make sure AC power to pump is turned off before checking power supply. Yellow LED on driver connector board should be flashing.
					Cross threaded CAN cable.	CAN cables carry 24 V DC power and communication between modules. A cross threaded CAN cable connector may cause problems with communication and/or power to modules. Carefully check for cross threaded CAN connections on the ADM and driver. Yellow LED on driver connector board should be flashing.
CBD_	Driver	Alarm	Communication Error U_-P_	Communication lost between pump and ADM	No AC power to driver.	Verify pump is turned on by confirming disconnect switch is in the ON position. Yellow LED on driver connector board should be flashing.
					AC disconnect switch broken	Disconnect pump from AC power. Check wiring to switch. If wiring is good, replace the AC disconnect switch.
					Ribbon cable disconnected	Disconnect pump from AC power. Verify that the ribbon cable inside driver casing is connected.
					Faulty driver control board	Replace driver control board.
CCD_	Driver	Alarm	Duplicate Module U_-P_	Multiple pumps using same pump ID	Two or more pumps have the same pump ID	Update the pumps displaying the error to the latest software available on help.graco.com.

Error	Location	Type	Error Name	Error Description	Cause	Solution
CCG_	Gateway	Alarm	Fieldbus Comm. Error U_-P_	No communication with the fieldbus	The automation gateway lost communication with the automation controller	Restore communications.
CCN_	Driver	Alarm	Control Board U_-P_	Communication lost between driver hot and cold boards	Software update failure	If software updates to the hot or cold driver boards fail before completion, then they will not be able to communicate. Update software to the latest available on help.graco.com .
					Cold board disconnected from hot board	Disconnect pump from AC power. Verify the cold board is securely fastened on the spacers above the hot board.
					Faulty driver control board	Replace driver control board.
DB1_ DB2_	Pump	Alarm or Deviation (user selectable)	Pump Not Primed U_-P_	Pump has not been primed since last empty drum	Replacing an empty drum with a new one	After replacing an empty drum, the pump must be primed before returning to operation (if alarm selected). Go to the pump run screen and push the lower right softkey to begin the priming sequence, then press the upper right softkey. Set the priming time in the setup screens. If deviation selected, prime pump if desired or clear deviation and return to normal pump operation.
DD3_ DD4_	Pump	Alarm or Deviation (user selectable)	Pump Diving U_-P_	Pump diving detected	Flow to pump inlet restricted	Check inlet valve is open or check inlet supply system for clogs
DEP_	Pump	Alarm	Pump Disable U_-P_	Pump is disable on the control box	The pump switch has been placed in the off position.	Please the switch back into the pump on position. If changing the drum, complete first before placing switch into the on position

Error	Location	Type	Error Name	Error Description	Cause	Solution
DKC_	Pump	Alarm	Crossover Error U_-P_	Crossover error in tandem system	Second pump is in an error state when crossover takes place	Clear the error(s) on the second pump.
EAUX	ADM	Advisory	Download to USB In Process	Information is currently being downloaded to USB	Download to USB initiated	No action necessary. Self-clearing
EBUX	ADM	Advisory	Download to USB Complete	Download to USB is complete	All requested information has finished downloading to USB	No action necessary. Self-clearing
EC0X	ADM	Record Only	Setup Values Changed	A setting in the setup screen was changed	A setting in the setup screens was changed	No action necessary if changes were desired.
EL0X	ADM	Record Only	Power On	The ADM was powered on	The ADM was powered on	No action necessary.
EM0X	ADM	Record Only	Power Off	The ADM was powered off	The ADM was powered off	No action necessary.
EVUX	ADM	Advisory	USB Disabled	USB downloads/uploads are disabled	USB download/upload was attempted, but USB activity is disabled within the setup screen	Advisory will clear when drive is removed. Enable USB downloads/uploads in setup screen if desired and reinsert USB drive.
F1D_ F2D_	Pump	Alarm or Deviation (user selectable)	Low Flow Rate U_-P_	Measured flow rate less than desired flow rate minus tolerance	Fluid supply too low to achieve desired flow rate	Increase fluid pressure to reach desired rate.
					Clog in fluid supply system	Check hose and other components in fluid supply system for clogs.
					No air pressure to solenoid valves	Turn on air to solenoid valves.
					No material supply	Replace drum and prime pump if desired.
					Incorrect flow tolerance	Enter correct flow tolerance percentage in setup screen.
F3D_ F4D_	Pump	Alarm or Deviation (user selectable)	High Flow Rate U_-P_	Measured flow rate greater than desired flow rate plus tolerance	Incorrect flow tolerance	Enter correct flow tolerance percentage in setup screen.

Error	Location	Type	Error Name	Error Description	Cause	Solution
L1C_	Pump	Alarm	Drum Empty U_-P_	Drum is empty	Drum is empty and needs to be replaced	Replace drum and prime pump if desired.
					Drum laser sensor is disconnected	Verify laser sensor is connected. Replace sensor if connection is good.
					Incorrect parameter	By using the laser sensor display, verify that the empty level is set to the desire level on setup screen.
L2C_	Pump	Deviation	Drum Low U_-P_	Drum is low	Fluid level in drum is low. Consider replacing soon	Clear deviation and return to normal pump operation.
					Drum laser sensor is disconnected	Verify laser sensor is connected. Replace sensor if connection is good.
					Incorrect parameter	By using the laser sensor display, verify that the low level is set to the desire level on setup screen.
L1D_	Pump	Alarm	Drum Not Present U_-P_	Drum is not present	There is no drum present on the ram unit	Place drum into the unit
					Drum present sensor is disconnected	Verify level sensor is connected. Replace sensor if connection is good.
L1P_	Pump	Alarm	Platen Not In Drum U_-P_	Platen is not in the drum	The platen is above the drum	Lower the platen into the drum
					Drum laser sensor is disconnected	Verify laser sensor is connected. Replace sensor if connection is good.
					Incorrect parameter	By using the laser sensor display, verify that the drum height is set to the desire level on setup screen.
MMUX	ADM	Advisory	USB Log 90% Full	One or more USB log is 90% full.	Data in the jobs or events log has not been downloaded recently and logs are nearly full.	Download the data or disable USB errors.

Error	Location	Type	Error Name	Error Description	Cause	Solution
MAD_	Pump	Advisory	Maint. Due Pump U_-P_	Maintenance due for pump	The number of pump cycles since last reset has exceeded the maintenance limit set	Perform desired maintenance and reset the pump cycles in the setup screen.
MBD_	Pump	Advisory	Maint. Due Driver U_-P_	Maintenance due for driver	The number of driver cycles since last reset has exceeded the maintenance limit set	Perform desired maintenance and reset the driver cycles in the setup screen.
MLC_	Pump	Advisory	Rebuild Platen Seals U_-P_	Maintenance due for platen seals	The number of replaced drums since last cycles reset has exceeded the maintenance limit set	Rebuild the platen seals if desired and reset the platen cycles in the setup screen.
P1C_ P2C_	Pump	Alarm or Deviation (user selectable)	Low Pressure U_-P_	Measured outlet pressure less than desired outlet pressure minus tolerance	Incorrect pressure tolerance	Enter correct pressure tolerance percentage in setup screen.
					Failed pressure transducer	Check transducer, replace if failed
					No or insufficient material flow	Increase material flow
					Restrictor not closed enough	Slowly close restrictor to build pressure
P4C_ P3C_	Pump	Alarm or Deviation (user selectable)	High Pressure U_-P_	Measured outlet pressure greater than desired outlet pressure plus tolerance	Incorrect pressure tolerance	Enter correct pressure tolerance percentage in setup screen.
					Failed pressure transducer	Check transducer, replace if failed
					Clog in fluid supply system	Check hose and other components in fluid supply system for clogs.
P6C_	Unit	Alarm	No Air Pressure U_-P_	Air Pressure is not turned on	The air pressure is not turned on	Verify that air pressure is on
					Sensor is disconnected	Verify sensor is connected. Replace sensor if connection is good.
P6D_	Pump	Deviation	Outlet Pressure Sensor U_-P_	Outlet pressure transducer not connected	The outlet pressure transducer is not connected or faulty	Verify outlet pressure transducer is installed and/or connected correctly. Replace if necessary.

Error	Location	Type	Error Name	Error Description	Cause	Solution
T2D_	Driver	Deviation	Motor Temperature Sensor U_-P_	Motor temperature thermistor disconnected	The motor temperature thermistor is not connected or faulty	Verify motor temperature thermistor is installed and/or connected correctly. Replace if necessary.
T3D_	Driver	Deviation	Temperature Cutback U_-P_	Current supplied to motor is being reduced in order to lower driver temperature	The control board temperature inside the driver is too high	Ensure ambient temperature is below 120F (48C). Ensure the enclosure fans are working properly.
					Enclosure fan not operating	Verify fan in electrical enclosure is spinning. If it is not, disconnect pump from AC power and check fan wiring or replace fan.
T4C_	Driver	Alarm	High Controls Temperature U_-P_	Temperature of the control board or motor is too hot	The control board temperature inside the driver is too high	Ensure ambient temperature is below 120F (48C).
					Enclosure fan not operating	Verify fan in electrical enclosure is spinning. If it is not, disconnect pump from AC power and check fan wiring or replace fan.
T4M_	Driver	Alarm	High Motor Temperature U_-P_	Temperature of the motor is too hot	The motor temperature inside the driver is too high	Ensure ambient temperature is below 120F (48C).
					Enclosure fan not operating	Verify fan in electrical enclosure is spinning. If it is not, disconnect pump from AC power and check fan wiring or replace fan.
V1M_	Driver	Alarm	Low Voltage U_-P_	Supplied bus voltage is below minimum acceptable limit	Transformer faulty	Check output voltage of transformer to verify it is within acceptable input limits.
					Incorrect line voltage	Check line voltage to verify it is as expected.

Error	Location	Type	Error Name	Error Description	Cause	Solution
V4M_	Driver	Alarm	High Voltage U_-P_	Supplied bus voltage is above maximum acceptable limit	Transformer faulty	Check output voltage of transformer to verify it is within acceptable input limits.
					Incorrect line voltage	Check line voltage to verify it is as expected.
WBD_	Driver	Alarm	Encoder Hardware U_-P_	Encoder or hall sensor disconnected or failed to commutate motor	Encoder disconnected or faulty	Disconnect pump from AC power. Verify encoder cable is properly connected. If so, replace encoder.
WMC_	Driver	Alarm	Control Board U_-P_	Control board reset due to an exception in software	Invalid software state	Cycle the power to the pump to reset the driver software.
					Software bug	Update software to the latest available on help.graco.com .
WMG0	Gateway	Alarm	Gateway Error Detected	Gateway error detected; includes any error not covered by a more specific error	Gateway Error Detected	Call technical assistance
WNG0	Gateway	Alarm	Gateway Map Error	Missing or invalid gateway map	Missing or invalid gateway map	Install map in gateway.
WSC_	Driver	Deviation	Encoder Calibration U_-P_	Encoder calibration information not found	Encoder not calibrated before or calibration information deleted	Perform encoder calibration through the setup screens of the ADM.
WSU0	ADM	Alarm	USB Configuration Error	USB configuration file not detected	USB configuration file not loaded or was deleted	Update software to the latest available on help.graco.com .

USB Data

Download Procedure

NOTE: If log files are not correctly saving to the USB flash drive (for example, missing or empty log files), save the desired data off of the USB flash drive and reformat it before repeating the download procedure.

NOTE: System configuration setting files and custom language files can be modified if the files are in the UPLOAD folder of the USB flash drive. See **System Configuration Settings**, page 70, **Custom Language File**, page 70, and **Upload Procedure** on page 71.

1. Insert the USB flash drive into the ADM USB port.
2. The menu bar and USB indicator lights indicate that the USB is downloading files. Wait for USB activity to complete.
3. Remove the USB flash drive from the USB port.
4. Re-insert the USB flash drive into the USB port of computer.
5. The USB flash drive window automatically opens. If it does not, open USB flash drive from within Windows[®] Explorer.
6. Open the GRACO folder.
7. Open the system folder. If downloading data from more than one system, there will be more than one folder. Each folder is labeled with the corresponding serial number of the ADM

NOTE: The serial number is on back of the ADM.

8. Open the DOWNLOAD folder.
9. Open the DATAxxxx folder.
10. Open the DATAxxxx folder labeled with the highest number. The highest number indicates the most recent data download.
11. Open the log file. Log files open in Microsoft[®] Excel by default as long as the program is installed. However, they can also be opened in any text editor or Microsoft[®] Word.

NOTE: All USB logs are saved in Unicode (UFT-16) format. If opening the log file in Microsoft Word, select Unicode encoding.

USB Logs

NOTE: The ADM can read/write to FAT (File Allocation Table) storage devices. NTFS, used by 32 GB or greater storage devices, is not supported.

During operation, the ADM stores system and performance related information to memory in the form of log files. The ADM maintains six log files:

- Event Log
- UX PX Log (Unit X - Pump X)
- Cycles Log

Follow the **Download Procedure**, page 69, to retrieve log files.

Each time a USB flash drive is inserted into the ADM USB port, a new folder named DATAxxxx is created. The number at the end of the folder name increases each time a USB flash drive is inserted and data is downloaded or uploaded.

Event Log

The event log file name is 1-EVENT.CSV and is stored in the DATAxxxx folder.

The event log maintains a record of the last 1,000 events and errors. Each event record contains:

- Date of event code
- Time of event code
- Event code
- Event Type
- Event Description

Event codes include both error codes (alarms, deviations, and advisories) and record only events.

Unit X - Pump X Log

The pump log file name is UXPX.csv and is stored in the DATAxxx folder. The first X is the unit number and the second X is the pump number.

There will be a pump log for every pump installed on the system. Each log maintains seven days worth of run data.

The pump log records the pressure and flow operating points of the pumps at 15 second intervals while the pump is enabled. The parameters recorded in this log are listed below.

- Target Outlet Pressure (bar)
- Actual Outlet Pressure (bar)
- Target Flow Rate (cc/min)
- Actual Flow Rate (cc/min)

Cycles Log

The cycles log file name is 8-CYCLES.csv and is stored in the DATAxxx folder.

The cycles log records driver and pump cycle information for each pump. The parameters recorded in this log are listed below.

- Pump ID
- Driver Lifetime Cycles
- Driver Maintenance Cycles
- Pump Maintenance Cycles
- Platen Maintenance Cycles
- Driver Cycles in 10% increments of Max Output Thrust

NOTE: Pump ID will display in UXPX, which corresponds to Unit X - Pump X.

System Configuration Settings

The system configuration settings file name is SETTINGS.TXT and is stored in the DOWNLOAD folder.

A system configuration settings file automatically downloads each time a USB flash drive is inserted into the ADM. Use this file to back up system settings for future recovery or to easily replicate settings across multiple systems. Refer to the **Upload Procedure** on page 71 for instructions on how to use this file.

Custom Language File

The custom language file name is DISPTXT.TXT and is stored in the DOWNLOAD folder.

A custom language file automatically downloads each time a USB flash drive is inserted into the ADM. If desired, use this file to create a user-defined set of custom language strings to be displayed within the ADM.

The system is able to display the following Unicode characters. For characters outside of this set, the system will display the Unicode replacement character, which appears as a white question mark inside of a black diamond.

- U+0020 - U+007E (Basic Latin)
- U+00A1 - U+00FF (Latin-1 Supplement)
- U+0100 - U+017F (Latin Extended-A)
- U+0386 - U+03CE (Greek)
- U+0400 - U+045F (Cyrillic)

Create Custom Language Strings

The custom language file is a tab-delimited text file that contains two columns. The first column consists of a list of strings in the language selected at the time of download. The second column can be used to enter the custom language strings. If a custom language was previously installed, this column contains the custom strings. Otherwise the second column is blank.

Modify the second column of the custom language file as needed and follow the **Upload Procedure** on page 71 to install the file.

The format of the custom language file is critical. The following rules must be followed in order for the installation process to succeed.

- Define a custom string for each row in the second column.

NOTE: If the custom language file is used, you must define a custom string for each entry in the DISPTXT.TXT file. Blank second-column fields will be displayed blank on the ADM.
- The file name must be DISPTXT.TXT.
- The file format must be a tab-delimited text file using Unicode (UTF-16) character representation.
- The file must contain only two columns, with columns separated by a single tab character.
- Do not add or remove rows to the file.
- Do not change the order of the rows.

Upload Procedure

Use this procedure to install a system configuration file and/or a custom language file.

1. If necessary, follow the **Download Procedure** to automatically generate the proper folder structure on the USB flash drive.
2. Insert USB flash drive into USB port of computer.
3. The USB flash drive window automatically opens. If it does not, open USB flash drive from within Windows Explorer.
4. Open GRACO folder.
5. Open the system folder. If working with more than one system, there will be more than one folder within the GRACO folder. Each folder is labeled with the corresponding serial number of the ADM (the serial number is on the back of the module).
6. If installing the system configuration settings file, place SETTINGS.TXT file into the UPLOAD folder.
7. If installing the custom language file, place DISPTXT.TXT file into the UPLOAD folder.
8. Remove USB flash drive from the computer.
9. Install USB flash drive into the ADM USB port.
10. The menu bar and USB indicator lights indicate that the USB is downloading files. Wait for USB activity to complete.
11. Remove USB flash drive from USB port.

NOTE: If the custom language file was installed, you can select the new language from the Language drop-down menu in **Advanced Setup Screen 1 – Standard ADM Settings** on page 41.

Communications Gateway Module (CGM)

Overview

The Communications Gateway Module (CGM) provides a control link between the E-Flo UniDrum system and a selected fieldbus. This provides the means for report monitoring and control by external automation systems.

NOTE: The following system network configuration files are available at help.graco.com.

- EDS file: DeviceNet or Ethernet/IP fieldbus networks
- GSD file: PROFIBUS fieldbus networks
- GSDML: PROFINET fieldbus networks

Connection Details

Fieldbus

Connect cables to fieldbus per fieldbus standards.

PROFINET

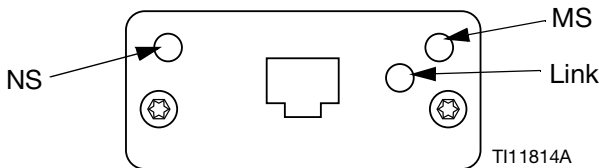

The Ethernet interface operates at 100M bit, full duplex, as required by PROFINET. The Ethernet interface is auto-polarity sensing and auto-crossover capable.

Network Status (NS)

State	Description	Comments
Off	Off-line	<ul style="list-style-type: none"> • No power • No connection with IO Controller
Green	On-line, (RUN)	<ul style="list-style-type: none"> • Connection with IO Controller established • IO Controller with RUN state
Flashing Green	On-line, (STOP)	<ul style="list-style-type: none"> • Connection with IO Controller established • IO Controller in STOP state

Module Status (MS)

State	Description	Comments
Off	Not initialized	No power or module in "SETUP" or "NW_INIT" state
Green	Normal operation	Diagnostic event(s) present
Flashing Green	Initialized, diagnostic event(s) present	Used by engineering tools to identify node on network
Red	Exception error	Module in state "EXCEPTION"
Red (1 flash)	Configuration error	Expected Identification differs from Real Identification
Red (2 flashes)	IP Address not set	Set IP address via system monitor or DNS server
Red (3 flashes)	Station Name not set	Set Station Name via system monitor
Red (4 flashes)	Major Internal Error	Cycle system power; replace module

Link/Activity (Link)

State	Description
Off	No Link, no communication present
Green	Link established, no communication present
Green, flashing	Link established, communication present

EtherNet/IP

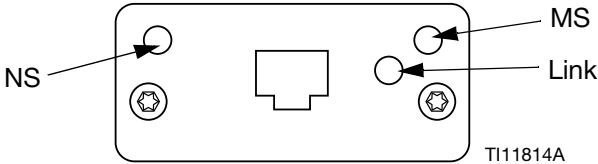

The Ethernet interface operates at 100Mbit, full duplex, as required by PROFINET. The Ethernet interface is auto-polarity sensing and auto-crossover capable.

Network Status (NS)

State	Description
Off	No power or no IP address
Green	On-line, one or more connections established (CIP Class 1 or 3)
Flashing Green	On-line, no connections established
Red	Duplicate IP address, FATAL error
Flashing Red	One or more connections timed out (CIP Class 1 or 3)

Module Status (MS)

State	Description
Off	No power
Green	Controlled by a Scanner in Run state
Flashing Green	Not configured, or Scanner in Idle state
Red	Major fault (EXCEPTION-state, FATAL error etc.)
Flashing Red	Recoverable fault(s)

LINK/Activity (Link)

State	Description
Off	No link, no activity
Green	Link established
Flashing Green	Activity

DeviceNet

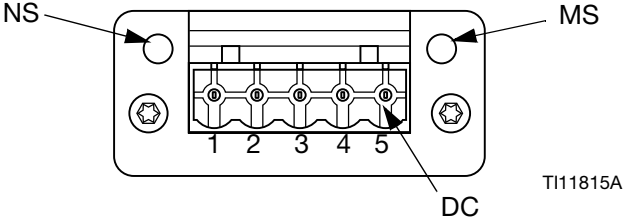

Network Status (NS)

State	Description
Off	Not online / No power
Green	On-line, one or more connections are established
Flashing Green (1 Hz)	On-line, no connections established
Red	Critical link failure
Flashing Red (1 Hz)	One or more connections timed-out
Alternating Red/Green	Self test

Module Status (MS)

State	Description
Off	No power or not initialized
Green	Initialized
Flashing Green (1 Hz)	Missing or incomplete configuration, device needs commissioning
Red	Unrecoverable Fault(s)
Flashing Red (1 Hz)	Recoverable Fault(s)
Alternating Red/Green	Self test

DeviceNet Connector (DC)

Pin	Signal	Description
1	V-	Negative bus supply voltage
2	CAN_L	CAN low bus line
3	SHIELD	Cable shield
4	CAN_H	CAN high bus line
5	V+	Positive bus supply voltage

PROFIBUS

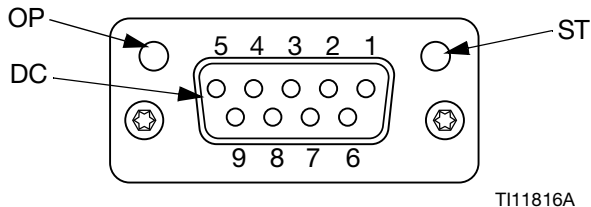

Operation Mode (OP)

State	Description
Off	Not online / No power
Green	On-line, data exchange
Flashing Green	On-line, clear
Flashing Red (1 flash)	Parameterization error
Flashing Red (2 flashes)	PROFIBUS Configuration error

Status Mode (ST)

State	Description
Off	No power or not initialized
Green	Initialized
Flashing Green	Initialized, diagnostic event(s) present
Red	Exception error

PROFIBUS Connector (DC)

Pin	Signal	Description
1	-	-
2	-	-
3	B Line	Positive RxD/TxD, RS485 level
4	RTS	Request to send
5	GND Bus	Ground (isolated)
6	+5V Bus Output	+5V termination power (isolated)
7	-	-
8	A Line	Negative RxD/TxD, RS485 level
9	-	-
Housing	Cable Shield	Internally connected to the Anybus protective earth via cable shield filters according to the PROFIBUS standard.

E-Flo UniDrum and PLC Connection Setup

Verify that the PLC parameters are set up correctly, see the Gateway Map table.

NOTE: If the PLC connection parameters are not setup correctly, the connection between the E-Flo UniDrum and PLC will not be made. The standard gateway map is 18D562. The map supports one ram system, or one tandem system with automatic crossover.

E-Flo UniDrum	
Gateway Map: 18D562	
Map Name On ADM: E-Flo UniDrum	
Comm. Format	Data-SINT
Input Assembly Instance:	100
Input Instance Size:	40
Output Assembly Instance:	150
Output Instance Size:	28

Available Internal Data

Unless stated otherwise, bytes are stored in each instance in little endian order (byte order within instance: most significant... least significant).

NOTE: Automation Outputs can be watched by the corresponding Automation Inputs to verify that the E-Flo UniDrum received the data.

Output from PLC / In to Graco E-Flo Unidrum

Tag ID	Description	Data Type	Min Value	Max Value	BIT	BYTE	Designator
1	SYS - Data Exchange Command	uint16	0	58	0-15	0-1	‡
2	U1 - System Enable Request	Boolean	0	1	0	2	‡
3	U1 - System Disable Request	Boolean	0	1	1		‡
4	U1 - PLC Control Lockout	Boolean	0	1	2		‡
5	U1 - Pumps Enabled	Boolean	0	1	3		‡
6	U1 - Pressure Control Enable	Boolean	0	1	4		‡
7	U1 - Flow Control Enabled	Boolean	0	1	5		‡
8	U1 - Acknowledge & Clear Errors	Boolean	0	1	6		‡
9	U1 - Prime Requested	Boolean	0	1	7		❖
10	U1 - Depressurization Request	Boolean	0	1	0		3
11	U1 - Cross Over Request	Boolean	0	1	1	‡	
12	U1 - {Reserved}	Boolean	-	-	2		
13	U1 - {Reserved}	Boolean	-	-	3		
14	U1 - {Reserved}	Boolean	-	-	4		
15	U1 - {Reserved}	Boolean	-	-	5		
16	U1 - {Reserved}	Boolean	-	-	6		
17	U1 - {Reserved}	Boolean	-	-	7		
18	U1 - Pressure Target (xx.x bar)	uint16	0	6553.5	0-15	4-5	‡
19	U1 - Flow Target (xx.x cc/min)	uint16	0	6553.5	0-15	6-7	‡
20	U1 - {Reserved}	uint32	-	-	0-31	8-11	
37	U2 - Pressure Target (xx.x bar)	uint16	0	6553.6	0-15	12-13	•
38	U2 - Flow Target (xx.x cc/min)	uint16	0	6553.6	0-15	14-15	•
40	U2 - {Reserved}	uint32	-	-	0-31	16-19	
41	SYS - Date Request	uint32	257	23268383	0-31	20-23	★
42	SYS - Time Request	uint32	0	18299707	0-31	24-27	★

‡ - Applies to the entire system.

† - Applies to the active Supply Unit.

❖ - Applies to the active Supply Unit if the active Supply Unit is disabled, applies to the inactive Supply Unit if the active Supply Unit is enabled.

• - Used for Purging on Tandem systems.

★ - Applies to the ADM only.

Key
System
Active Unit
Inactive Unit

Input to PLC / Out from Graco E-Flo Unidrum

Tag ID	Description	Data Type	Min Value	Max Value	BIT	BYTE	Designator
1	U1 - Heartbeat	Boolean	0	1	0	0	‡
2	U1 - Automation Control Ready	Boolean	0	1	1		‡
3	U1 - PLC Control Lockout Active	Boolean	0	1	2		‡
4	U1- System is enabled	Boolean	0	1	3		‡
5	U1 - Pumps trying to move	Boolean	0	1	4		‡
6	U1 - Pumps is actually moving	Boolean	0	1	5		‡
7	U1 - No Active Unit Alarms	Boolean	0	1	6		‡
8	U1 - No Active Unit Deviations	Boolean	0	1	7		‡
9	U1 - No Active Unit Advisories	Boolean	0	1	0	1	‡
10	U1 - Prime Active	Boolean	0	1	1		‡
11	U1 - Depressurization Active	Boolean	0	1	2		‡
12	U1 - Drum Low	Boolean	0	1	3		‡
13	U1 - Drum Empty	Boolean	0	1	4		‡
14	U1 - Not primed	Boolean	0	1	5		‡
15	U1 - Drum not in place	Boolean	0	1	6		‡
16	U1 - Platen not in drum	Boolean	0	1	7		‡
17	U1 - Pumps disabled from Control Box	Boolean	0	1	0	2	‡
18	U1 - Unit 1 active (tandem system only)	Boolean	0	1	1		‡
19	U1 - {Reserved}	Boolean	0	1	2		‡
20	U1 - {Reserved}	Boolean	0	1	3		‡
21	U1 - {Reserved}	Boolean	0	1	4		‡
22	U1 - {Reserved}	Boolean	0	1	5		‡
23	U1 - {Reserved}	Boolean	0	1	6		‡
24	U1 - {Reserved}	Boolean	0	1	7		‡

Tag ID	Description	Data Type	Min Value	Max Value	BIT	BYTE	Designator
25	U1 - {Reserved}	Boolean	0	1	0	3	‡
26	U1 - {Reserved}	Boolean	0	1	1		‡
27	U1 - {Reserved}	Boolean	0	1	2		‡
28	U1 - {Reserved}	Boolean	0	1	3		‡
29	U1 - {Reserved}	Boolean	0	1	4		‡
30	U1 - {Reserved}	Boolean	0	1	5		‡
31	U1 - {Reserved}	Boolean	0	1	6		‡
32	U1 - {Reserved}	Boolean	0	1	7		‡
33	U1 - Actual Unit Flowrate Rate (xxxx cc/min)	uint16	0	65535	0-15	4-5	‡
34	U1 - Unit Outlet Pressure (xx.x bar)	uint16	0	6553.5	0-15	6-7	‡
36	U1 - Drum Material Reaming (xxx%)	uint16	0	100	0-15	8-9	‡
37	U1 - Data Exchange Active Command	uint16	0	58	0-15	10-11	‡
38	U1 - Data Exchange Active Command Value	uint32	0	4294967295	0-31	12-15	‡
39	U2 - Heartbeat	Boolean	0	1	0	16	†
40	U2 - Automation Control Ready	Boolean	0	1	1		†
41	U2 - PLC Control Lockout Active	Boolean	0	1	2		†
42	U2 - System is enabled	Boolean	0	1	3		†
43	U2 - Pumps trying to move	Boolean	0	1	4		†
44	U2 - Pumps is actually moving	Boolean	0	1	5		†
45	U2 - No Active Unit Alarms	Boolean	0	1	6		†
46	U2 - No Active Unit Deviations	Boolean	0	1	7		†
47	U2 - No Active Unit Advisories	Boolean	0	1	0	17	†
48	U2 - Prime Active	Boolean	0	1	1		†
49	U2 - Depressurization Active	Boolean	0	1	2		†
50	U2 - Drum Low	Boolean	0	1	3		†
51	U2 - Drum Empty	Boolean	0	1	4		†
52	U2 - Not primed	Boolean	0	1	5		†
53	U2 - Drum not in place	Boolean	0	1	6		†
54	U2 - Platen not in drum	Boolean	0	1	7		†

Tag ID	Description	Data Type	Min Value	Max Value	BIT	BYTE	Designator
55	U2 - Pumps disabled from Control Box	Boolean	0	1	0	18	†
56	U2 - Unit 1 active (tandem system only)	Boolean	0	1	1		†
57	U2 - {Reserved}	Boolean	0	1	2		†
58	U2 - {Reserved}	Boolean	0	1	3		†
59	U2 - {Reserved}	Boolean	0	1	4		†
60	U2 - {Reserved}	Boolean	0	1	5		†
61	U2 - {Reserved}	Boolean	0	1	6		†
62	U2 - {Reserved}	Boolean	0	1	7		†
63	U2 - {Reserved}	Boolean	0	1	0	19	†
64	U2 - {Reserved}	Boolean	0	1	1		†
65	U2 - {Reserved}	Boolean	0	1	2		†
66	U2 - {Reserved}	Boolean	0	1	3		†
67	U2 - {Reserved}	Boolean	0	1	4		†
68	U2 - {Reserved}	Boolean	0	1	5		†
69	U2 - {Reserved}	Boolean	0	1	6		†
70	U2 - {Reserved}	Boolean	0	1	7		†
71	U2 - Actual Pump Flowrate Rate (xxxx cc/min)	uint16	0	65535	0-15	20-21	†
72	U2 - Pump Outlet Pressure (xx.x bar)	uint16	0	6553.5	0-15	22-23	†
73	U1 - Drum Material Reaming (xxx%)	uint16	0	100	0-15	24-25	†
75	U2 - Data Exchange Active Command	uint16	0	58	0-15	26-27	†
76	U2 - Data Exchange Active Command Value	uint32	0	4294967295	0-31	28-31	†
77	SYS - Current Date	uint32	257	6491167	0-31	32-35	★
78	SYS - Current Time	uint32	0	1522491	0-31	36-39	★

‡ - Conveys the status of the active Supply Unit only.
 † - Conveys the status of the inactive Supply Unit only.
 ❖ - The status of both Supply Units are taken into account.
 ★ - Conveys the status of the ADM.

Key
System
Active Unit
Inactive Unit

Data Exchange

NOTE: Please reference the timing diagrams on the timing of the signals to utilize the Data Exchange.

NOTE: Keep a spacing of 50ms between data exchange requests.

The Data Exchange is a condensed structure that is used to read a number of different variables in one data location. If multiple are needed they must be cycled through.

The Data Exchange is a method of:

1. Setting “SYS – Data Exchange Command” a 16 bit integer (byte 0-1).
2. Reading - “U1 – Data Exchange Active Command” a 16 bit integer (byte 10-11).
3. Reading - “U1 – Data Exchange Active Command Value” a 32 bit integer (byte 12-15).

Example:

How to read the cycle rate on the Supply Unit through the Data Exchange.

1. Set bytes 0-1 to 6 (base 10).
2. Read bytes 10-11 to ensure that it reads 6 (base 10).
3. Read bytes 12-15 to get the active cycle rate of the Supply Unit.

E-Flo Unidrum Data Exchange

Command Value (base 10 decimal)	Name	Units/Format
0	Pump 1 Active Alarms	Bitfield
1	Pump 1 Active Deviations	Bitfield
2	Pump 1 Active Advisories	Bitfield
3	Pump 2 Active Alarms	Bitfield
4	Pump 2 Active Deviations	Bitfield
5	Pump 2 Active Advisories	Bitfield
6	Unit Cycle Rate	1/10 CPM
7	Unit Pump Size	cc
8	Unit Target Pressure	1/10 bar
9	Unit Target Flow	cc/min
10	Pump 1 Position	Percentage Stroke (0 = bottom, 100 = top)
11	Pump 2 Position	Percentage Stroke (0 = bottom, 100 = top)
12	Pump 1 Driver Lifetime Cycles	Cycles
13	Pump 1 Driver Resettable Cycles	Cycles
14	Pump 1 Pump Resettable Cycles	Cycles
15	Pump 1 Platen Resettable Cycles	Cycles
16	Pump 1 Driver Cycles by Thrust, 0-9% (LifeTime)	Cycles
17	Pump 1 Driver Cycles by Thrust, 10-19% (LifeTime)	Cycles
18	Pump 1 Driver Cycles by Thrust, 20-29% (LifeTime)	Cycles
19	Pump 1 Driver Cycles by Thrust, 30-39% (LifeTime)	Cycles
20	Pump 1 Driver Cycles by Thrust, 40-49% (LifeTime)	Cycles
21	Pump 1 Driver Cycles by Thrust, 50-59% (LifeTime)	Cycles
22	Pump 1 Driver Cycles by Thrust, 60-69% (LifeTime)	Cycles
23	Pump 1 Driver Cycles by Thrust, 70-79% (LifeTime)	Cycles
24	Pump 1 Driver Cycles by Thrust, 80-89% (LifeTime)	Cycles
25	Pump 1 Driver Cycles by Thrust, 90-100% (LifeTime)	Cycles
26	Pump 1 Driver Cycles by Thrust, 0-9% (Ressettable)	Cycles
27	Pump 1 Driver Cycles by Thrust, 10-19% (Ressettable)	Cycles
28	Pump 1 Driver Cycles by Thrust, 20-29% (Ressettable)	Cycles

Command Value (base 10 decimal)	Name	Units/Format
29	Pump 1 Driver Cycles by Thrust, 30-39% (Ressettable)	Cycles
30	Pump 1 Driver Cycles by Thrust, 40-49% (Ressettable)	Cycles
31	Pump 1 Driver Cycles by Thrust, 50-59% (Ressettable)	Cycles
32	Pump 1 Driver Cycles by Thrust, 60-69% (Ressettable)	Cycles
33	Pump 1 Driver Cycles by Thrust, 70-79% (Ressettable)	Cycles
34	Pump 1 Driver Cycles by Thrust, 80-89% (Ressettable)	Cycles
35	Pump 1 Driver Cycles by Thrust, 90-100% (Ressettable)	Cycles
36	Pump 2 Driver Lifetime Cycles	Cycles
37	Pump 2 Driver Resetable Cycles	Cycles
38	Pump 2 Pump Resetable Cycles	Cycles
39	Pump 2 Driver Cycles by Thrust, 0-9% (LifeTime)	Cycles
40	Pump 2 Driver Cycles by Thrust, 10-19% (LifeTime)	Cycles
41	Pump 2 Driver Cycles by Thrust, 20-29% (LifeTime)	Cycles
42	Pump 2 Driver Cycles by Thrust, 30-39% (LifeTime)	Cycles
43	Pump 2 Driver Cycles by Thrust, 40-49% (LifeTime)	Cycles
44	Pump 2 Driver Cycles by Thrust, 50-59% (LifeTime)	Cycles
45	Pump 2 Driver Cycles by Thrust, 60-69% (LifeTime)	Cycles
46	Pump 2 Driver Cycles by Thrust, 70-79% (LifeTime)	Cycles
47	Pump 2 Driver Cycles by Thrust, 80-89% (LifeTime)	Cycles
48	Pump 2 Driver Cycles by Thrust, 90-100% (LifeTime)	Cycles
49	Pump 2 Driver Cycles by Thrust, 0-9% (Ressettable)	Cycles
50	Pump 2 Driver Cycles by Thrust, 10-19% (Ressettable)	Cycles
51	Pump 2 Driver Cycles by Thrust, 20-29% (Ressettable)	Cycles
52	Pump 2 Driver Cycles by Thrust, 30-39% (Ressettable)	Cycles
53	Pump 2 Driver Cycles by Thrust, 40-49% (Ressettable)	Cycles
54	Pump 2 Driver Cycles by Thrust, 50-59% (Ressettable)	Cycles
55	Pump 2 Driver Cycles by Thrust, 60-69% (Ressettable)	Cycles
56	Pump 2 Driver Cycles by Thrust, 70-79% (Ressettable)	Cycles
57	Pump 2 Driver Cycles by Thrust, 80-89% (Ressettable)	Cycles
58	Pump 2 Driver Cycles by Thrust, 90-100% (Ressettable)	Cycles

Time and Date Information

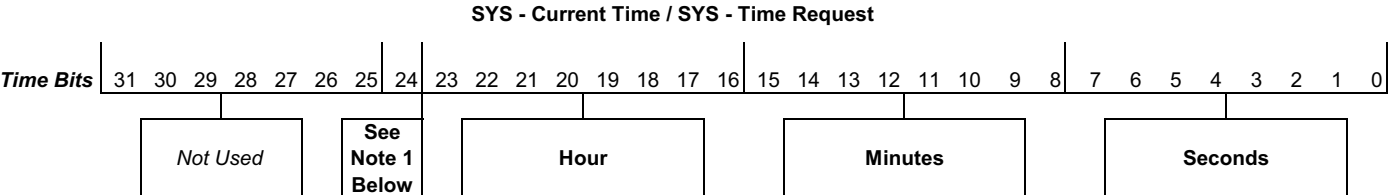
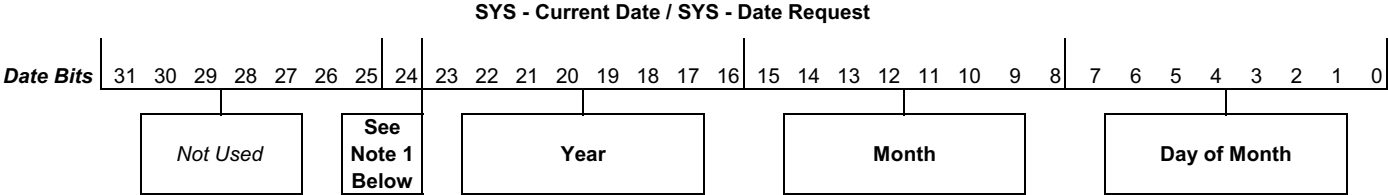

- Notes:**
- 1. Bit 24 must be set high in order for the request of the internal date or time to be set. Once the request is sent, bit 24 must be set low, otherwise future requests will be ignored.
 - 2. If an invalid date or time is requested, the request will be ignored.

Timing Diagrams

NOTE: 50ms is required between all signal requests.

“Automation Control Ready” in the following diagrams represents the following:

- System is enabled
- No active alarms
- ADM is in “Remote Mode”

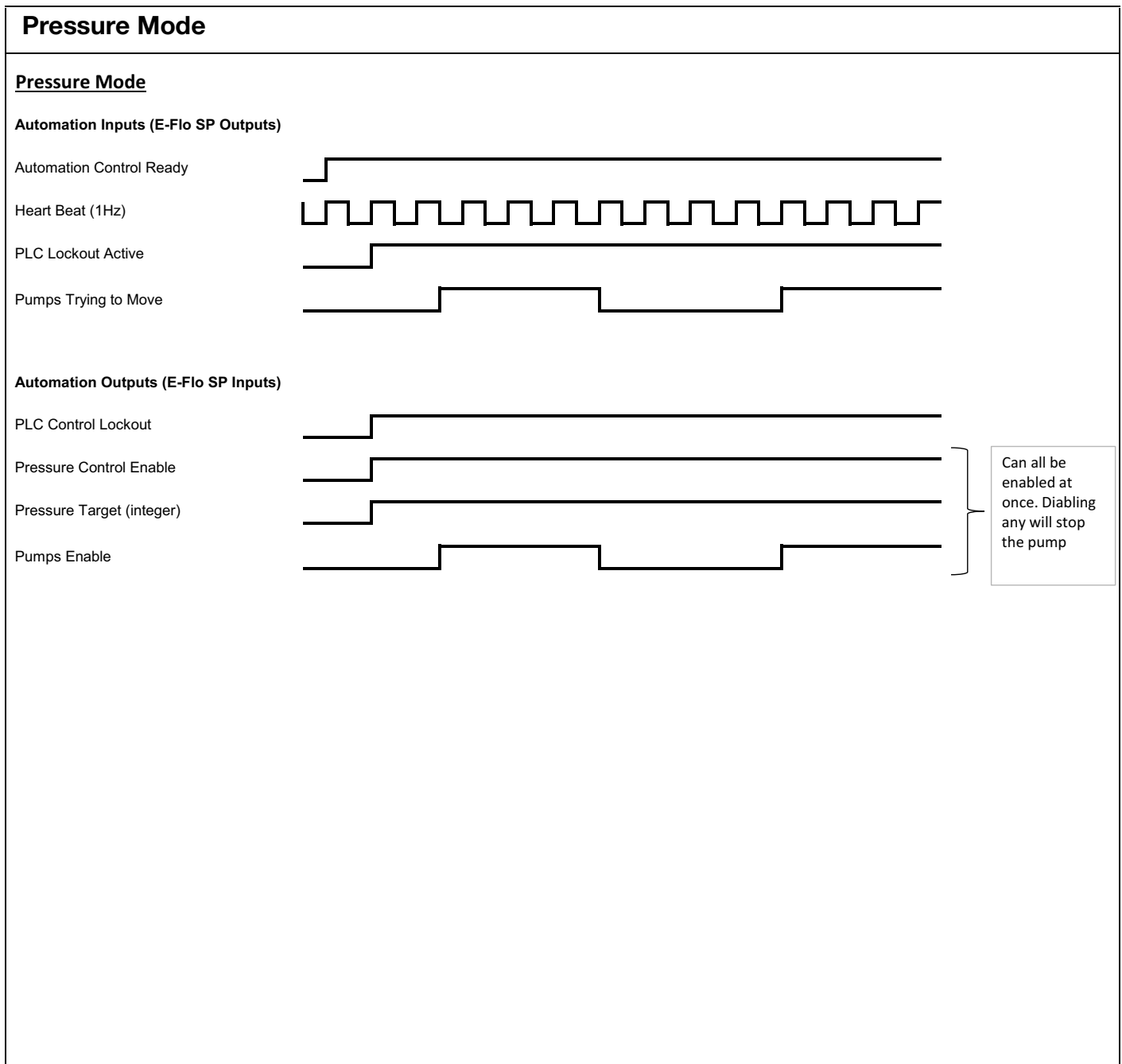

Flow Mode

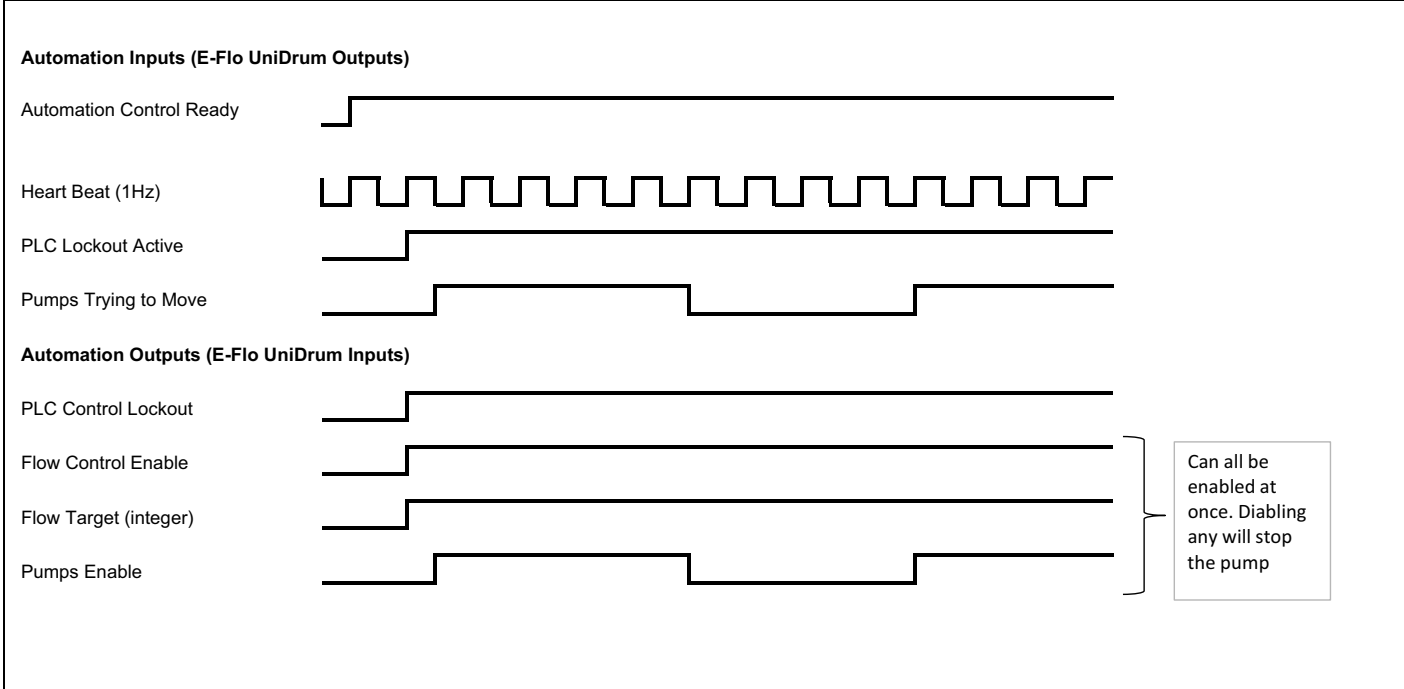

Pressure Flow Combined

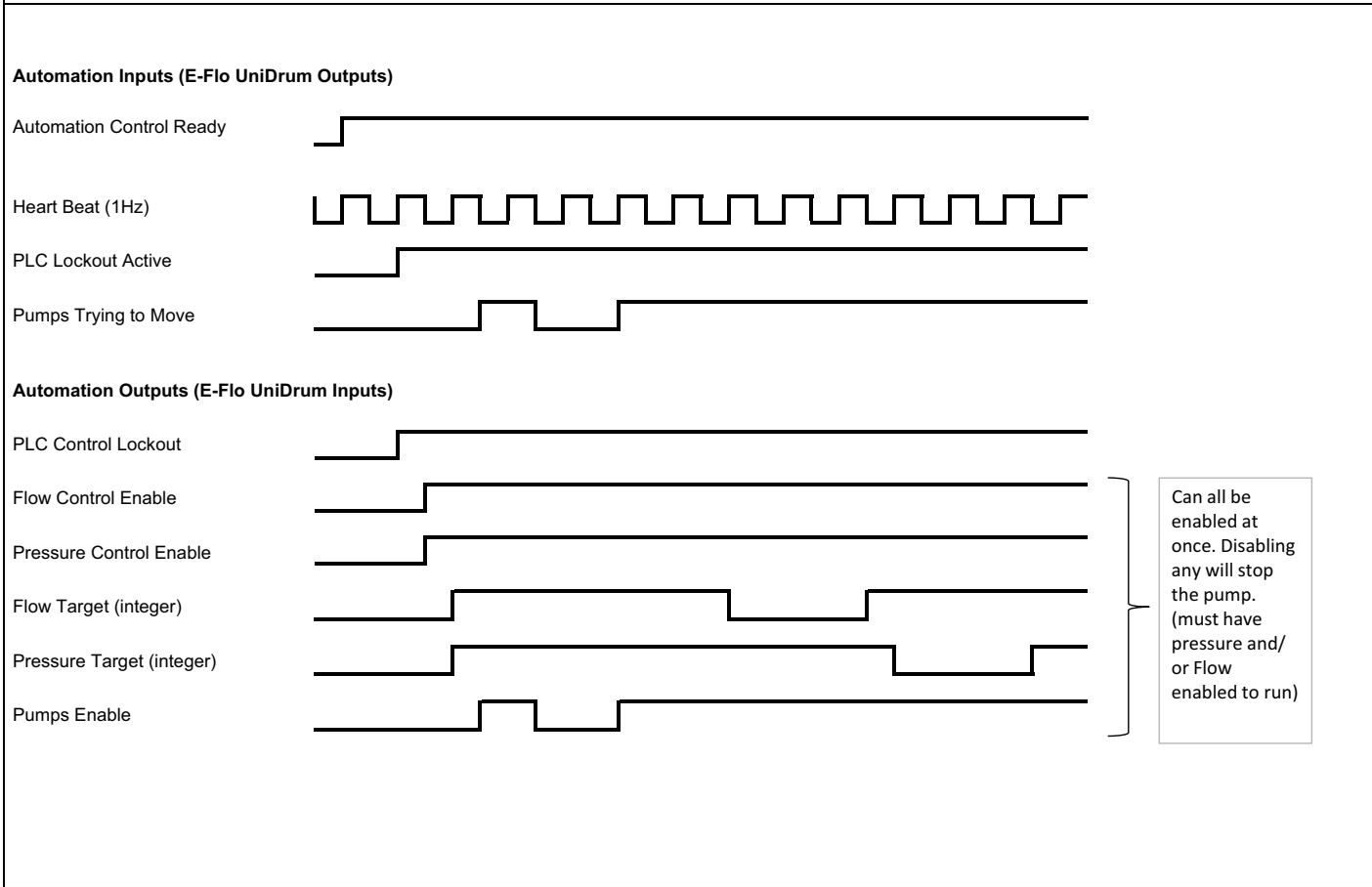

Prime

Automation Inputs (E-Flo UniDrum Outputs)

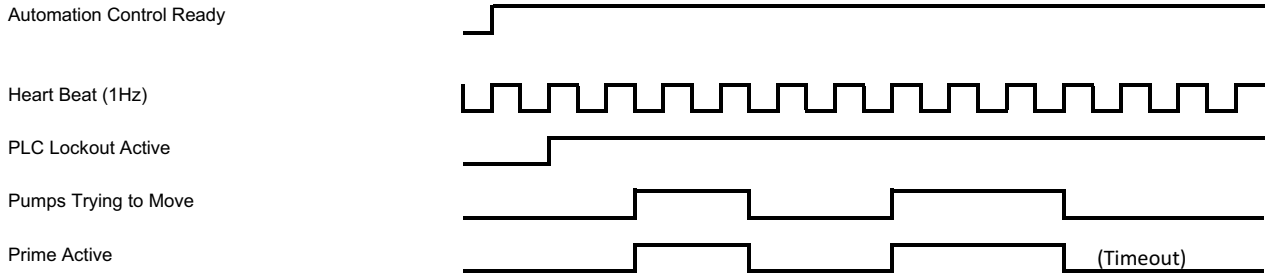

Automation Outputs (E-Flo UniDrum Inputs)

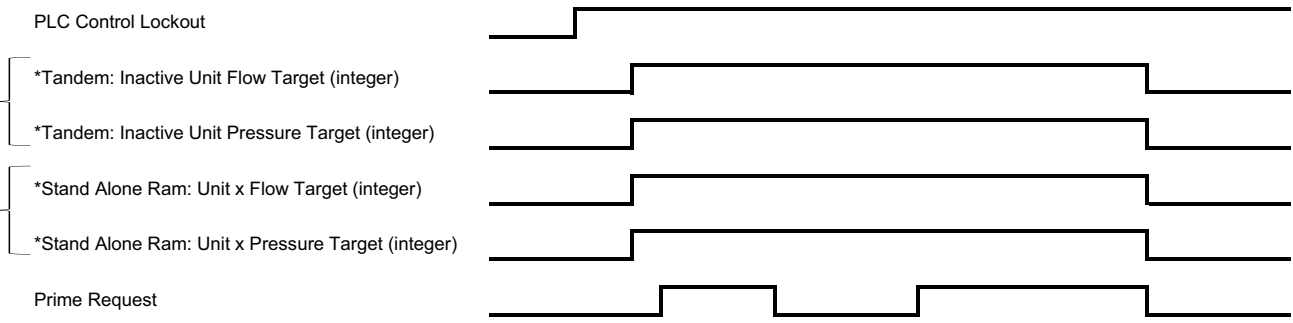

*Both must have a value greater than zero to start the priming process.

Depressurization

To utilize the Depressurization feature:

- Fluid solenoid kit must be installed and enabled on the ADM Setup Screen
- ADM is in "Remote Mode"
- Unit Crossover, Prime Request, or Pumps Enable cannot be active

Automation Inputs (E-Flo UniDrum Outputs)

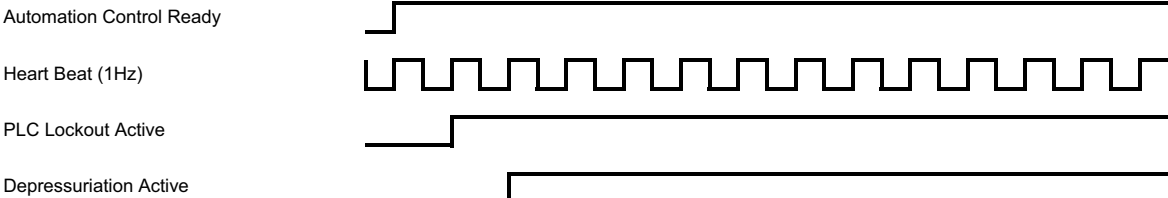

Automation Outputs (E-Flo UniDrum Inputs)

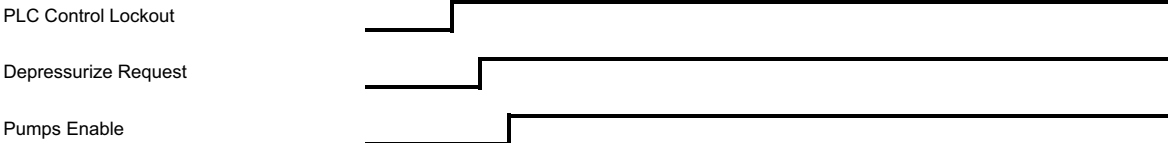

System Enable Request

Automation Inputs (E-Flo UniDrum Outputs)

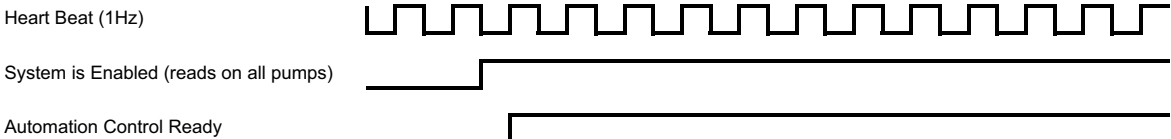

Automation Outputs (E-Flo UniDrum Inputs)



System Disable Request

Automation Inputs (E-Flo UniDrum Outputs)

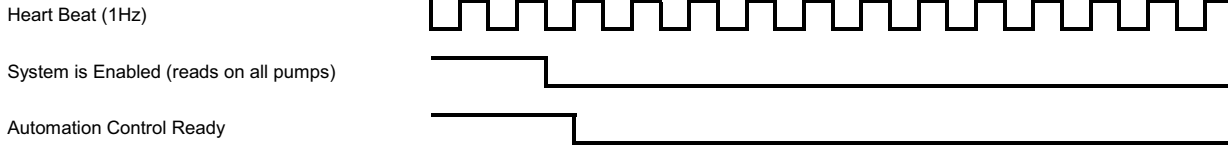

Automation Outputs (E-Flo UniDrum Inputs)



Ack-Clear Error

Automation Inputs (E-Flo UniDrum Outputs)

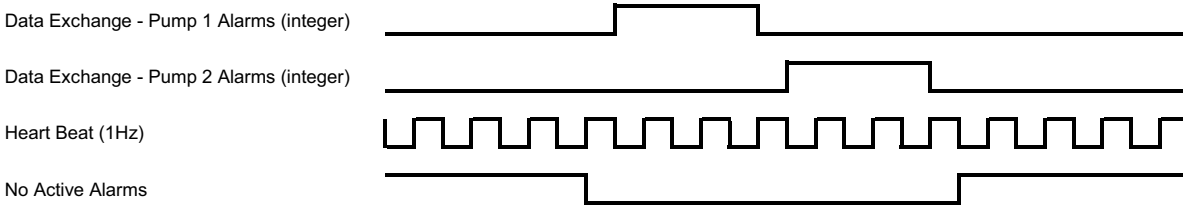

Automation Outputs (E-Flo UniDrum Inputs)



NOTE: The same process can be used when reading deviations and advisories.
NOTE: All errors (alarms, deviations, advisories) must be read for all units pumps before sending the Ack-Clear Error bit.

Crossover

To utilize Crossover feature:

- Must have a Tandem system
- ADM is in “Remote Mode”
- Prime Request and Depressurization Request cannot be active

Automation Inputs (E-Flo UniDrum Outputs)

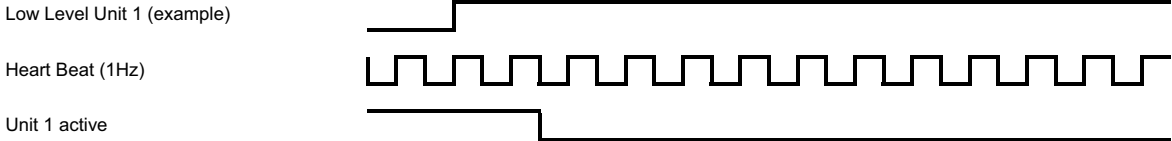

Automation Outputs (E-Flo UniDrum Inputs)



Data Exchange

Automation Inputs (E-Flo UniDrum Outputs)

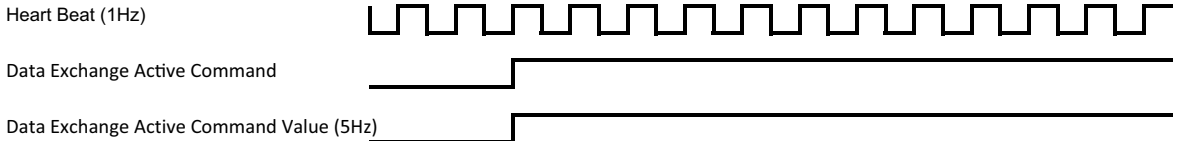

Automation Outputs (E-Flo UniDrum Inputs)



Error Code Handling

As indicated in the Available Internal Data section, and the Ack-Clear Internal Data timing diagram, any Unit Pump (U_ - P_) error condition (Alarm, Deviation or Advisory) is reported to the controlling PLC using the Data Exchange Interface. As an example, if the PLC wants to know if an active deviation exists for Unit 1 - Pump 2, the PLC needs to write a 4 to the PLC output bytes 0 and 1. Then read the Data Exchange Active Command Value (PLC input bytes 12-15) after the Data Exchange Active Command equals 4 (requested command). If the value read by the Data Exchange Active Command Value equals 0, there are no active deviations for that pump location.

The following actions should be taken if a Supply Unit reports a non-zero value.

1. The PLC requested if an alarm condition existed for Unit 1, by sending a 0 to PLC output bytes 0 and 1, then reading the Data Exchange Active Command Value (PLC input bytes 12-15) after the Data Exchange Active Command (PLC input bytes 10-11) reported a 0.
2. Unit 1 reports a 514 decimal (0 x 0202 hexadecimal, or base 16) on the Data Exchange Active Command Value location 12-15 (Input bytes 12-15).
3. As indicated in the **Active Alarm Descriptions** table on page 91, the 514 reported indicates a V4M_ and a DD4_ condition ($512 + 2 = 514$) exists for Unit 1.
4. To acknowledge and clear the alarm condition, the PLC will need to implement the items outlined in the Ack - Clear Error timing diagram, by activating the Acknowledge / Clear Errors bit for Unit 1 (PLC output byte 2, bit 6).
5. The pop-up window for the error conditions will be cleared. If both conditions are removed, the No Active Alarms bit from the Unit 1 (E-Flo output byte 0 bit 6) will be set back to high and the Unit 1 - Data Exchange Value from Unit 1 will be set to 0. If only the DD4_ condition is cleared, the No Active Alarms bit will remain low, and the data exchange value will change from 514 to 2.

NOTE: See **Troubleshooting** on page 56 for causes and solutions for error codes.

Active Alarm Descriptions (Data Exchange Command Value = 0 or 3)

Data Exchange Values Bit Assignments	Resultant Value from Bit Assignment (Base 10)	Resultant Value from Bit Assignment (Base 16)	Alarm Code	Alarm Name
0	1	1	V1M_	Low Voltage -U_-P_
1	2	2	V4M_	High Voltage -U_-P_
2	4	4	T4M_	High Motor Temperature -U_-P_
3	8	8	T4C_	High Controls Temperature -U_-P_
4	16	10	WBD_	Encoder Hardware -U_-P_
5	32	20	CCN_	Control Board -U_-P_
6	64	40	A4N_	High Motor Current -U_-P_
7	128	80	WMC_	Control Board -U_-P_
8	256	100	A4D_	High Motor Current -U_-P_
9	512	200	DD4_	Pump Diving -U_-P_
10	1024	400	P4C_	High Pressure -U_-P_
11	2048	800	P1C_	Low Pressure -U_-P_
12	4096	1000	F4D_	High Flow Rate -U_-P_
13	8192	2000	F1D_	Low Flow Rate -U_-P_
14	16384	4000	P6D_	Outlet Pressure Sensor -U_-P_
15	32768	8000	DKC_	Crossover Error -U_-P_
16	65536	10000	L1C_	Drum Empty -U_-P_
17	131072	20000	DB1_	Pump Not Primed -U_-P_
18	262144	40000	CCG_	Fieldbus Comm. Error -U_-P_
19	524288	80000	CAC_	Display Comm. Error -U_-P_
20	1048576	100000	CAD_	Driver Offline -U_-P_
21	2097152	200000	L1D_	Drum Not Present -U_-P_
22	4194304	400000	L1P_	Platen Not in Drum -U_-P_
23	8388608	800000	DEP_	Pumps Disabled-U_-P_
24	16777216	1000000	P6C_	No Air Pressure-U_-P_

Active Deviation Descriptions (Data Exchange Command Value = 1 or 4)

Data Exchange Values Bit Assignments	Resultant Value from Bit Assignment (Base 10)	Resultant Value from Bit Assignment (Base 16)	Deviation Code	Deviation Name
0	1	1	T2D_	Motor Temperatures Sensor -U_-P_
1	2	2	T3D_	Temperature Cutback -U_-P_
2	4	4	WSC_	Encoder Calibration -U_-P_
3	8	8	DD3_	Pump Diving -U_-P_
4	16	10	P3C_	High Pressure -U_-P_
5	32	20	P2C_	Low Pressure -U_-P_
6	64	40	F3D_	High Flow Rate -U_-P_
7	128	80	F2D_	Low Flow Rate -U_-P_
8	256	100	P6D_	Outlet Pressure Sensor -U_-P_
9	512	200	L2C_	Drum Low -U_-P_
10	1024	400	DB2_	Pump Not Primed -U_-P_

Active Advisory Descriptions (Data Exchange Command Value = 2 or 5)

Data Exchange Values Bit Assignments	Resultant Value from Bit Assignment (Base 10)	Resultant Value from Bit Assignment (Base 16)	Advisory Code	Advisory Name
0	1	1	MBD_	Maint. Due Driver -U_-P_
1	2	2	MAD_	Maint. Due Pump -U_-P_
2	4	4	MLC_	Rebuild Platen Seals -U_-P_

Setup

Gateway Screens

The Gateway screens are used to configure the fieldbus. These screens are shown only if a CGM is correctly installed in your system. See **Communication Gateway Module (CGM) Kits** on page 25 for installation instructions.

1. With the system on and enabled, press  to access the Setup screens.
2. Press the left arrow key twice to navigate to the main Gateway screen.

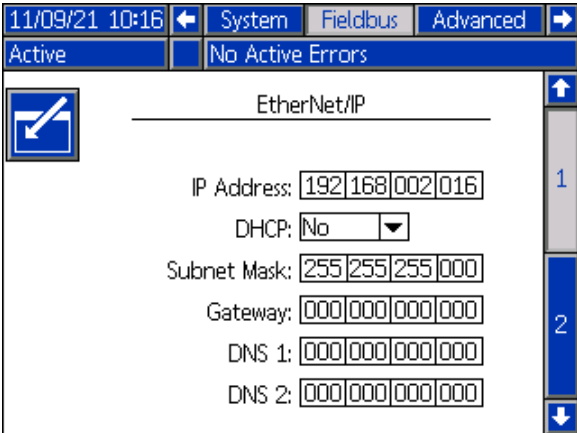

PROFIBUS Fieldbus Screens

These screens are shown only if a PROFIBUS Fieldbus CGM is installed.

Screen 1

This screen enables the user to set the device address, install date, location tag, function tag, and description.

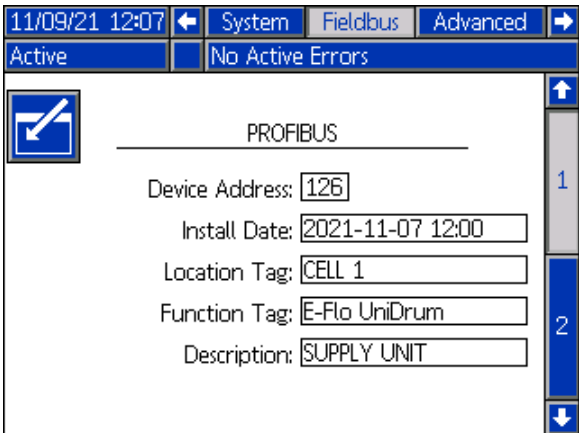

Screen 2

This screen displays the hardware revision, system serial number, and data map identification information.

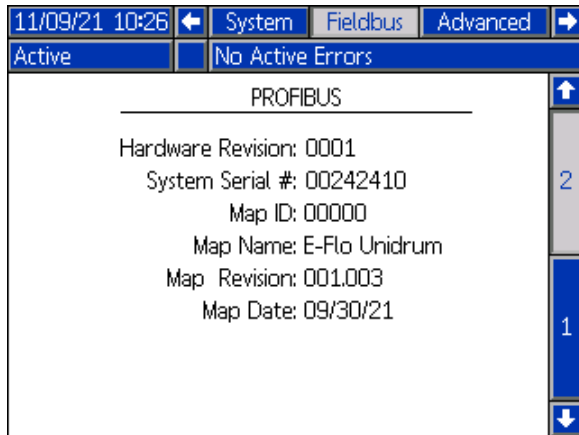

PROFINET Fieldbus Screens

These screens are shown only if a PROFINET Fieldbus CGM is installed.

Screen 1

This screen enables the user to set the IP Address, DHCP settings, subnet mask, gateway, and DNS information.

11/09/21 12:12 | System | Fieldbus | Advanced

System Off | No Active Errors

PROFINET

IP Address: 192|168|002|016

DHCP: No

Subnet Mask: 255|255|255|000

Gateway: 000|000|000|000

DNS 1: 000|000|000|000

DNS 2: 000|000|000|000

Screen 2

This screen enables the user to set the station name, install date, location tag, function tag, and description.

11/09/21 10:20 | System | Fieldbus | Advanced

Active | No Active Errors

PROFINET

Station Name: gca-cgm

Install Date: 2021-11-07 12:00

Location Tag: CELL 1

Function Tag: E-Flo UniDrum

Description: SUPPLY UNIT

Screen 3

This screen displays the hardware revision, system serial number, and data map identification information.

11/09/21 10:21 | System | Fieldbus | Advanced

Active | No Active Errors

PROFINET

Hardware Revision: 0001

System Serial #: 00292245

Map ID: 00000

Map Name: E-Flo Unidrum

Map Revision: 001.003

Map Date: 09/30/21

EtherNet/IP Fieldbus Screens

These screens are shown only if an EtherNet/IP Fieldbus CGM is installed.

Screen 1

This screen enables the user to set the IP address, DHCP settings, subnet mask, gateway, and DNS information.

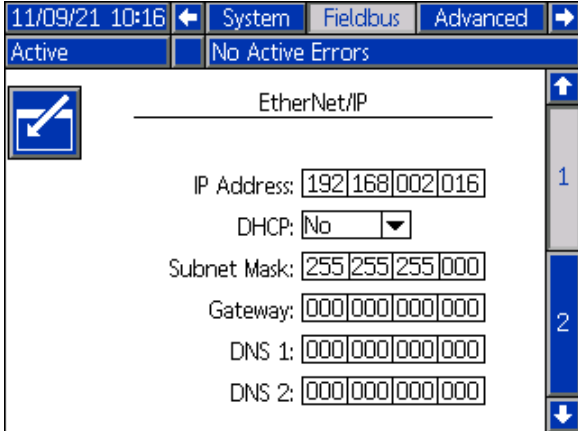

Screen 2

This screen displays the hardware revision, system serial number, and data map identification information.

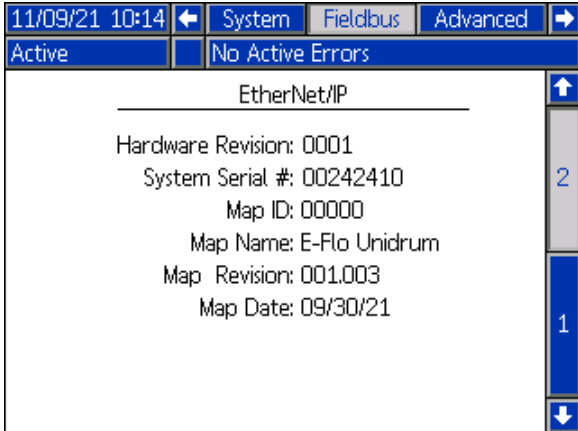

DeviceNet Fieldbus Screen

This screen is shown only if a DeviceNet Fieldbus CGM is installed.

This screen enables the user to set the device address and baud rate, as well as view the hardware revision, system serial number, and data map identification information.



Electrical Diagrams

Control Box

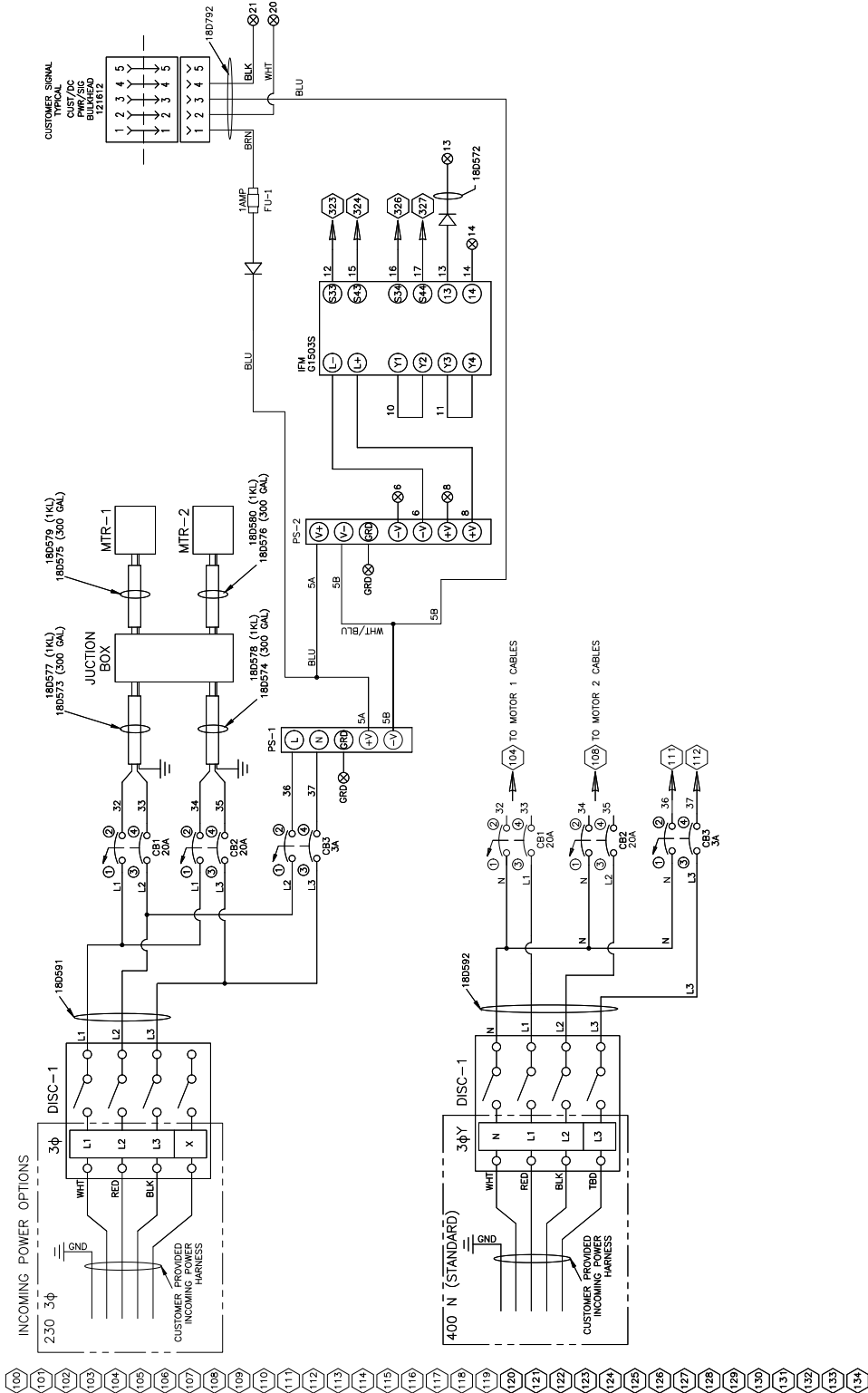

Fig. 36

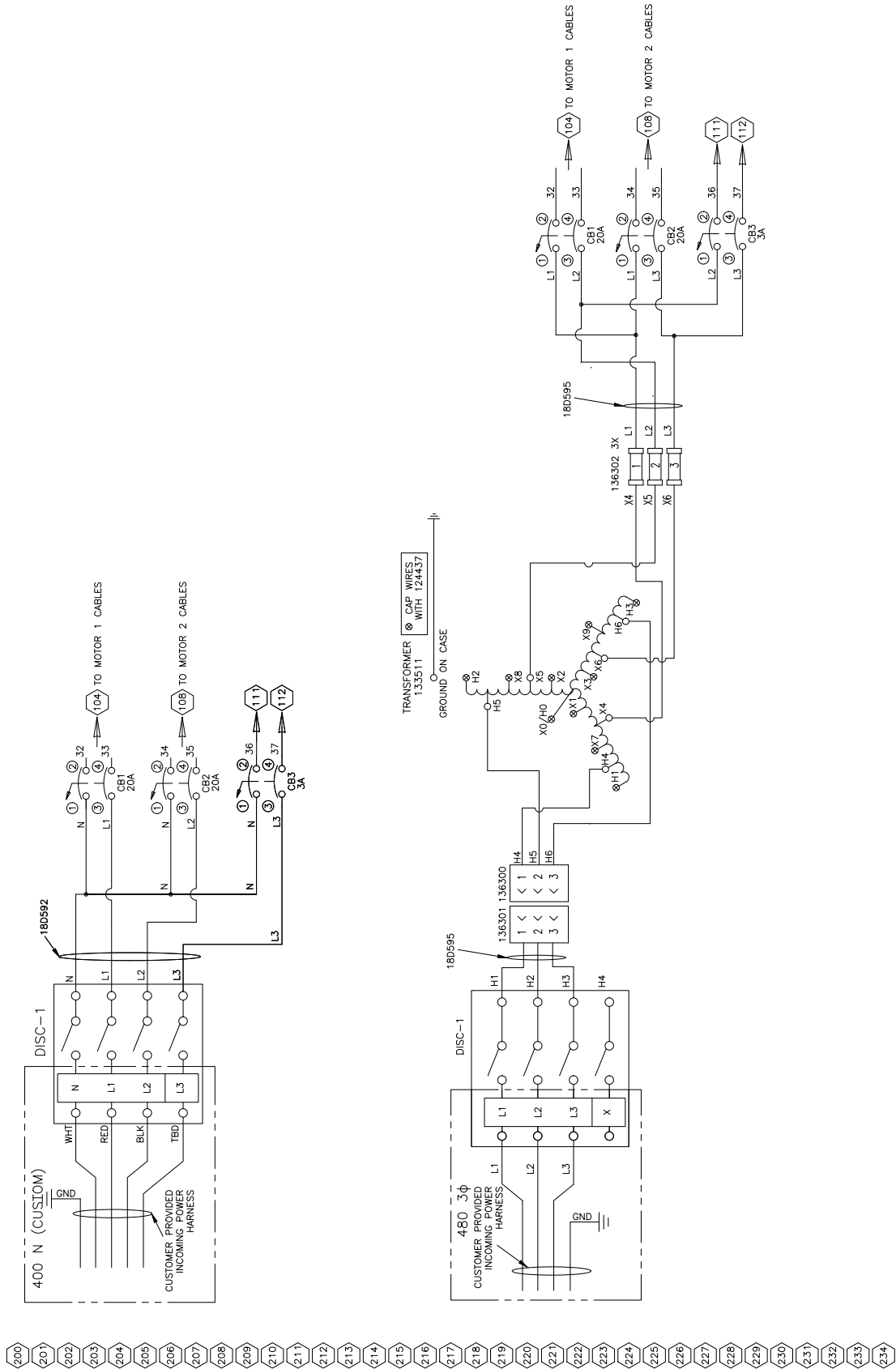

FIG. 37

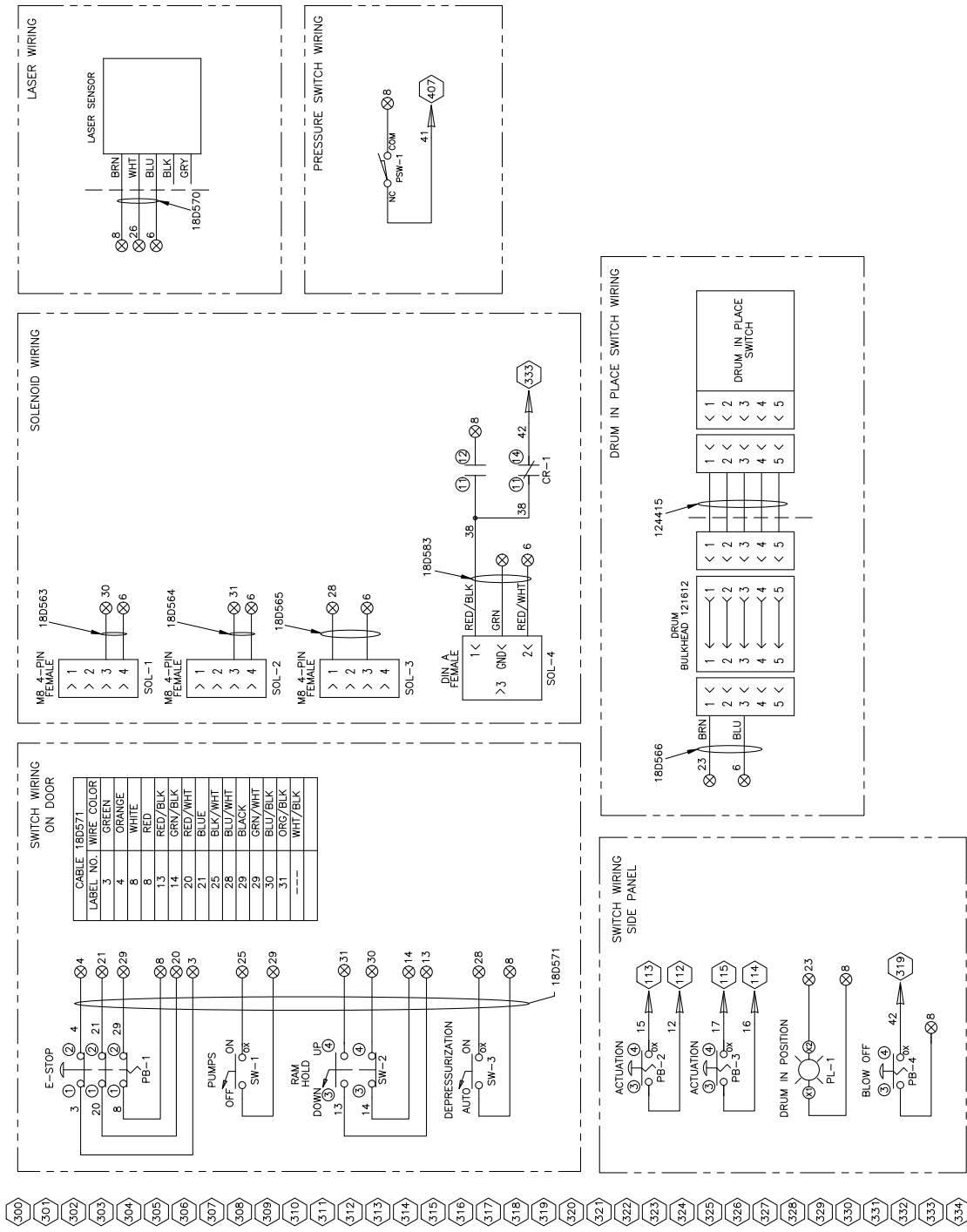

Fig. 38

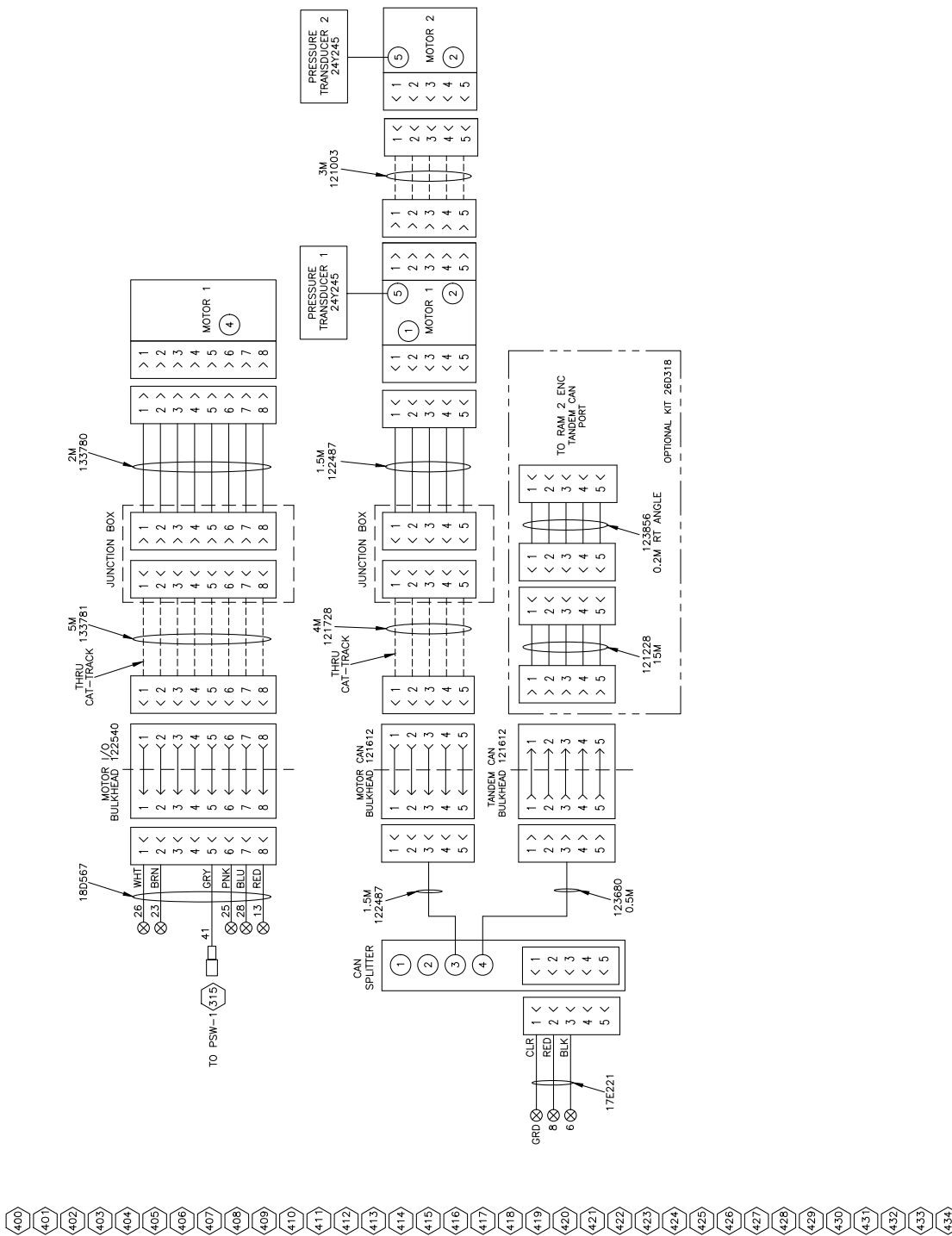

FIG. 39

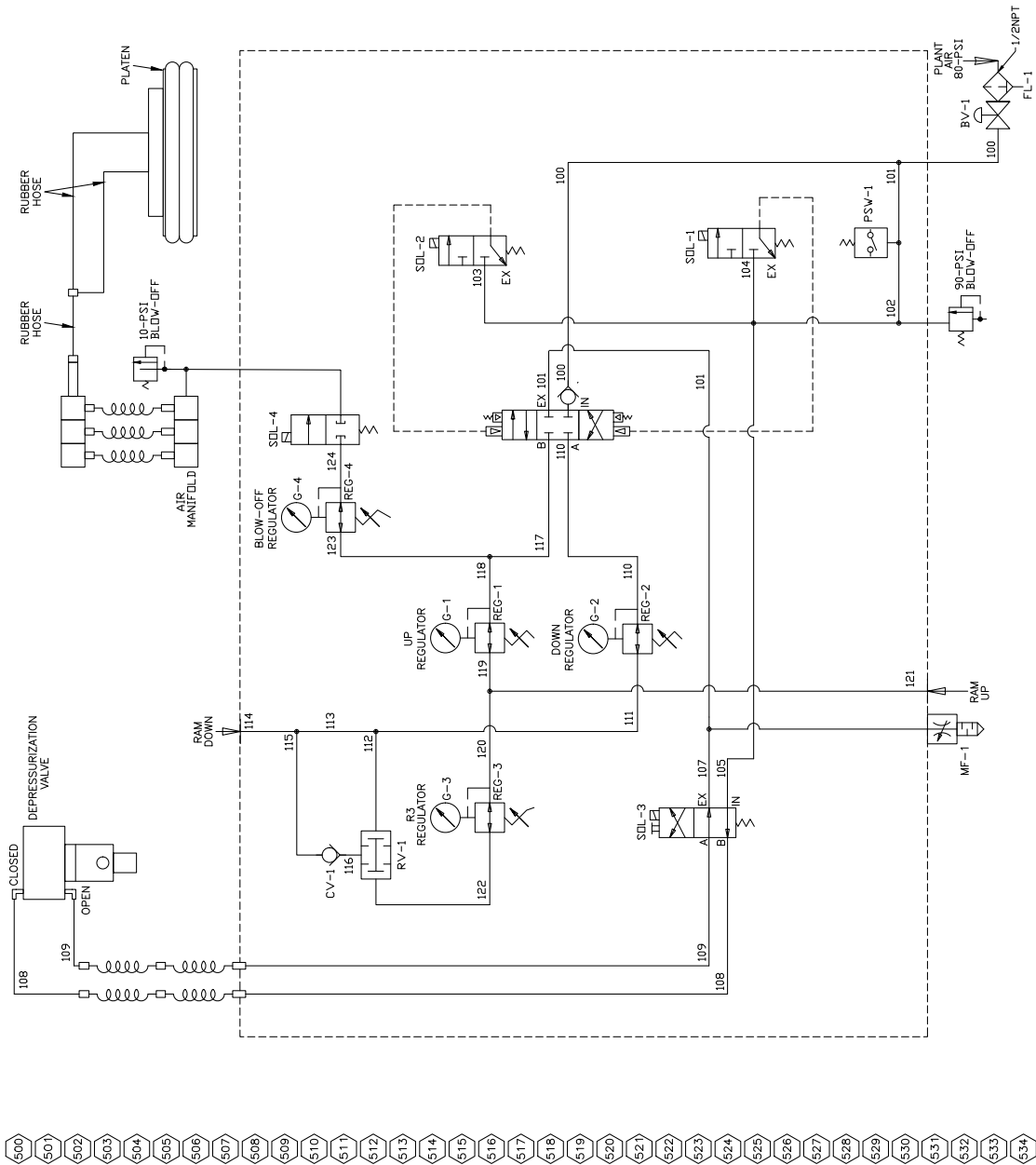

Fig. 40

Pneumatic Diagram

Control Box

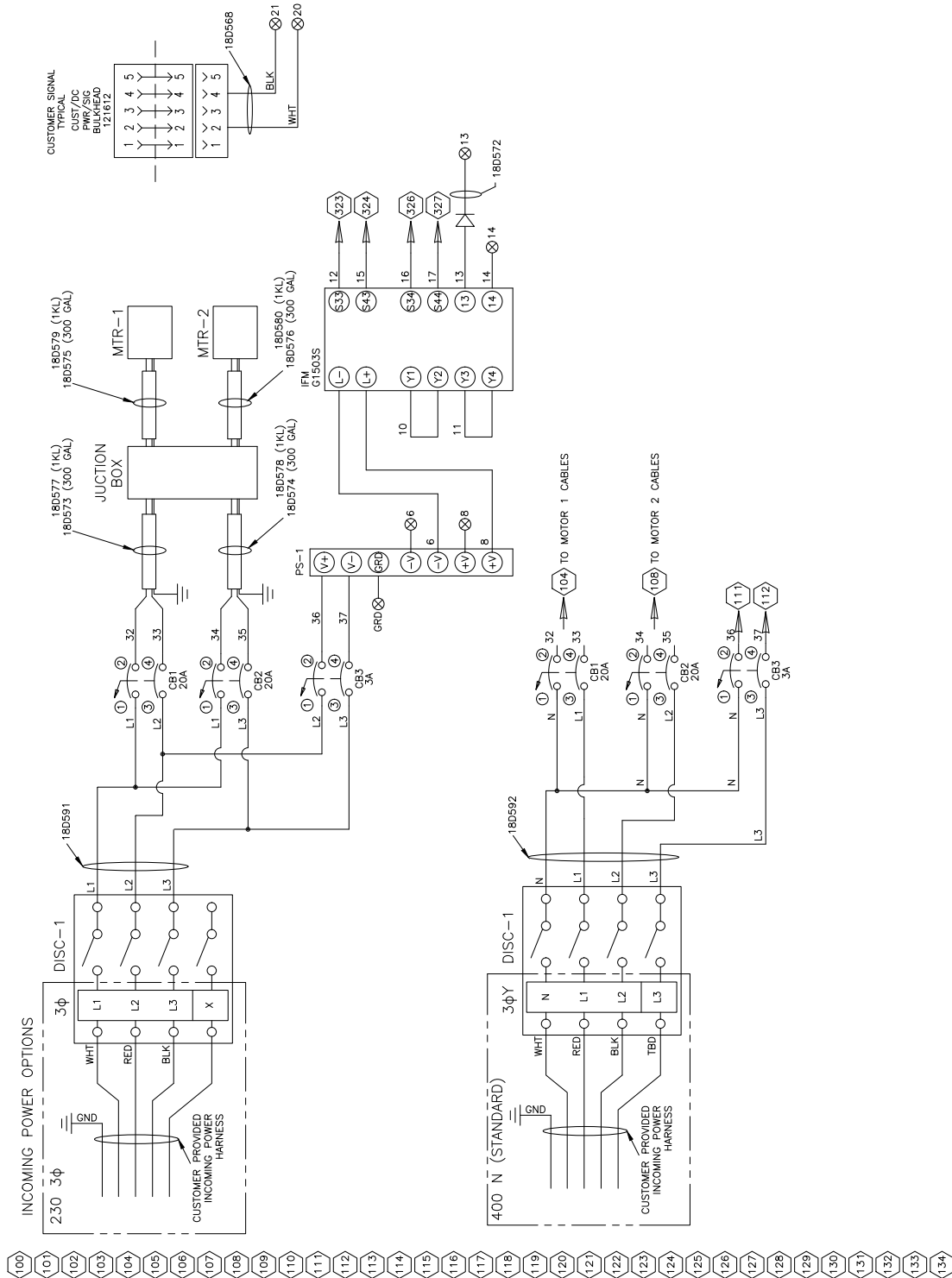
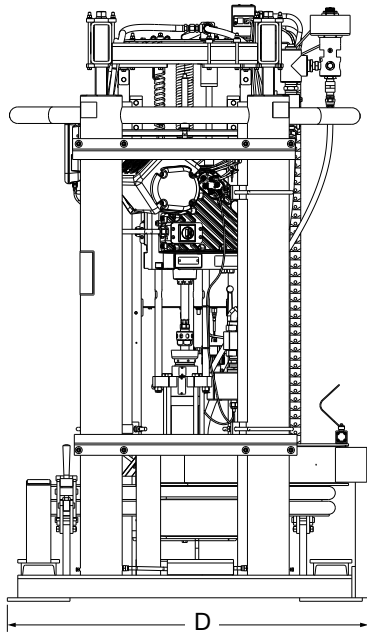
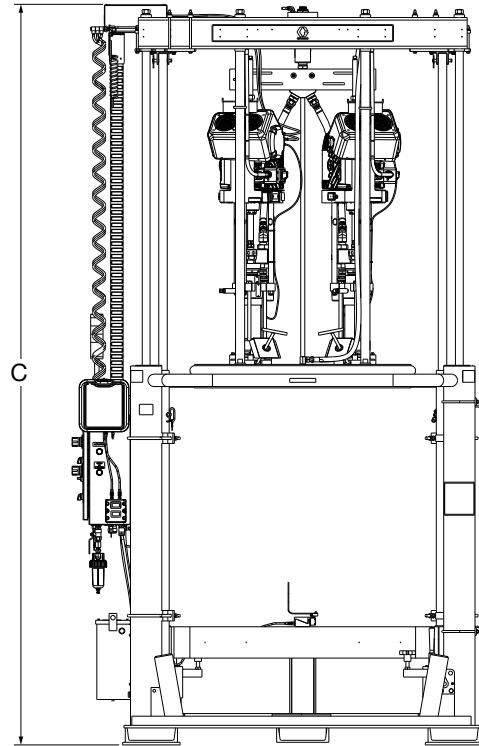
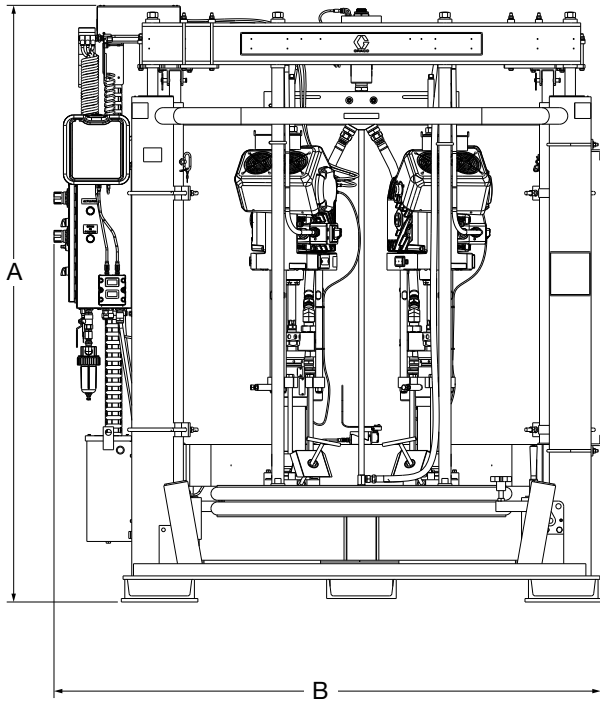

FIG. 41

Dimensions

300 Gallon Units



300 Gallon Dimensions in. (mm)	
A	85.7 (2177)
B	78.7 (1999)
C	141.9 (3605)
D	51.9 (1319)

FIG. 42

1000 Liter Units

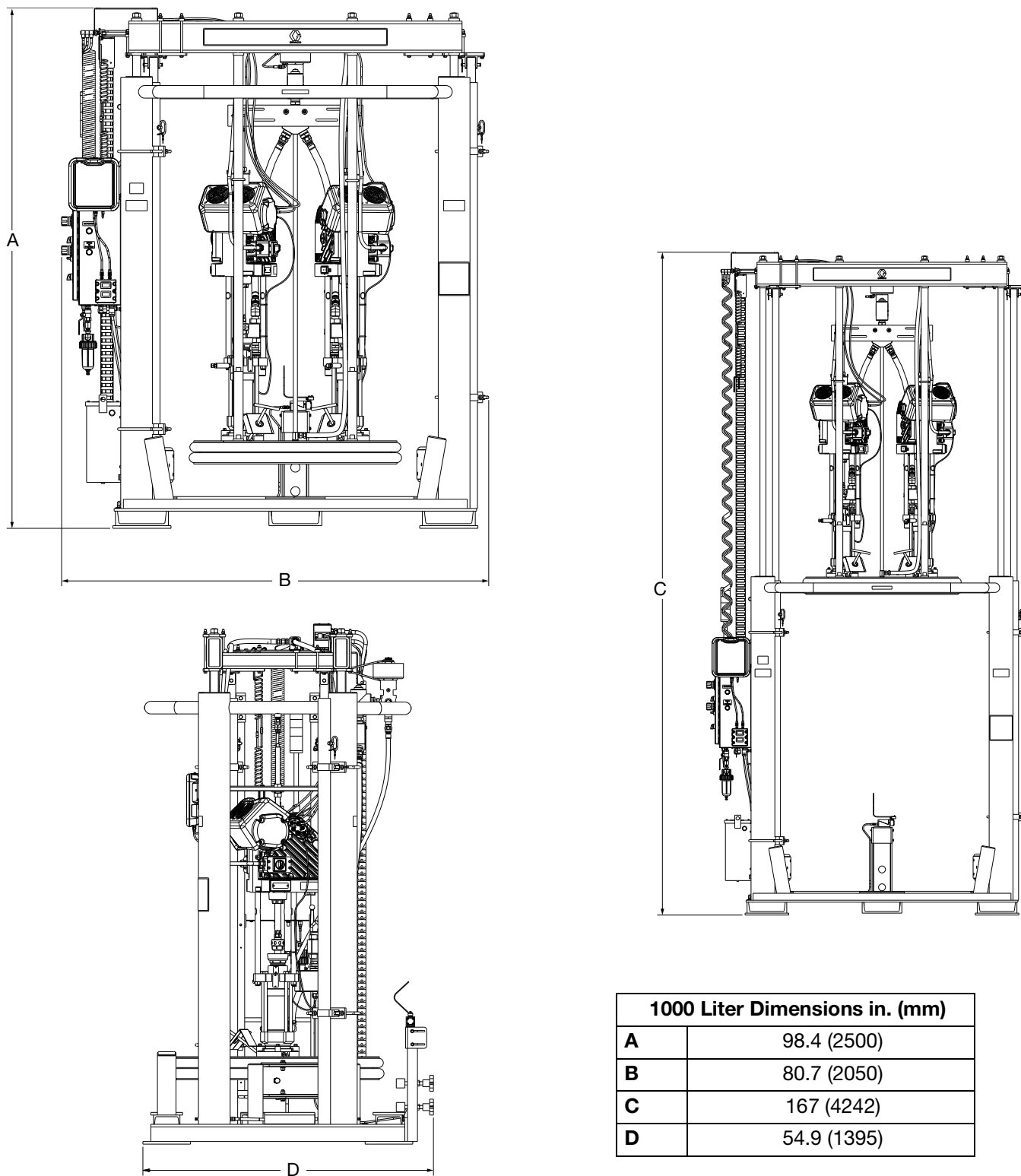

FIG. 43

Technical Specifications

E-Flo UniDrum Supply System		
	US	Metric
Driver thrust	4840 lbs	2195 kg
Stroke length	4.75 in.	120.65 mm
Maximum fluid operating temperature	180°F	82.3°C
Maximum driver cycle rate	25 cycles per minute	
Line voltage (depending on model)	200-240 VAC, 3Ø Delta, 50/60 Hz 380-420 VAC, 3Ø, Wye, 50/60 Hz 420-480 VAC, 3Ø Delta, 50/60 Hz	
Compressed air requirement	80 psi (max)	0.55 MPa, 5.5 bar (max)
Main air inlet size	1/2 in. npt(f)	
Fluid outlet size	1-1/4 in. npt(f)	
Ambient operating temperature range (supply system)	41-104°F	5-40°C
Displacement pump effective area	See pump manual. See Related Manuals on page 3.	
Wetted parts	See pump manual. See Related Manuals on page 3.	
Full Load Amperage		
240V systems	20A	
400V systems	35A	
480V systems	10A	
Maximum Fluid Working Pressure		
290cc Dura-Flo	2800 psi (193 bar, 19.3 MPa)	
430cc Dura-Flo	1900 psi (131 bar, 13.1 MPa)	
300 Gallon Supply System Overall Dimensions		
Width	85.7 in.	2177 mm
Depth	78.7 in.	1999 mm
Height (lowered)	141.9 in.	3605 mm
Height (raised)	51.9 in.	1319 mm
Weight (approximate)	1450 lbs	1882 kg
1000 Liter Supply System Overall Dimensions		
Width	98.4 in.	2500 mm
Depth	80.7 in.	2050 mm
Height (lowered)	167 in.	4242 mm
Height (raised)	54.9 in.	1395 mm
Weight (approximate)	1450 lbs	1882 kg
Noise (dBA)		
Normal operation (dispensing)	< 70 dBA	
Drum change	102.5 dBA	
<i>Sound pressure measured per EN ISO-11202:2010</i>		

California Proposition 65

CALIFORNIA RESIDENTS

 **WARNING:** Cancer and reproductive harm – www.P65warnings.ca.gov.

Graco Standard Warranty

Graco warrants all equipment referenced in this document which is manufactured by Graco and bearing its name to be free from defects in material and workmanship on the date of sale to the original purchaser for use. With the exception of any special, extended, or limited warranty published by Graco, Graco will, for a period of twelve months from the date of sale, repair or replace any part of the equipment determined by Graco to be defective. This warranty applies only when the equipment is installed, operated and maintained in accordance with Graco's written recommendations.

This warranty does not cover, and Graco shall not be liable for general wear and tear, or any malfunction, damage or wear caused by faulty installation, misapplication, abrasion, corrosion, inadequate or improper maintenance, negligence, accident, tampering, or substitution of non-Graco component parts. Nor shall Graco be liable for malfunction, damage or wear caused by the incompatibility of Graco equipment with structures, accessories, equipment or materials not supplied by Graco, or the improper design, manufacture, installation, operation or maintenance of structures, accessories, equipment or materials not supplied by Graco.

This warranty is conditioned upon the prepaid return of the equipment claimed to be defective to an authorized Graco distributor for verification of the claimed defect. If the claimed defect is verified, Graco will repair or replace free of charge any defective parts. The equipment will be returned to the original purchaser transportation prepaid. If inspection of the equipment does not disclose any defect in material or workmanship, repairs will be made at a reasonable charge, which charges may include the costs of parts, labor, and transportation.

THIS WARRANTY IS EXCLUSIVE, AND IS IN LIEU OF ANY OTHER WARRANTIES, EXPRESS OR IMPLIED, INCLUDING BUT NOT LIMITED TO WARRANTY OF MERCHANTABILITY OR WARRANTY OF FITNESS FOR A PARTICULAR PURPOSE.

Graco's sole obligation and buyer's sole remedy for any breach of warranty shall be as set forth above. The buyer agrees that no other remedy (including, but not limited to, incidental or consequential damages for lost profits, lost sales, injury to person or property, or any other incidental or consequential loss) shall be available. Any action for breach of warranty must be brought within two (2) years of the date of sale.

GRACO MAKES NO WARRANTY, AND DISCLAIMS ALL IMPLIED WARRANTIES OF MERCHANTABILITY AND FITNESS FOR A PARTICULAR PURPOSE, IN CONNECTION WITH ACCESSORIES, EQUIPMENT, MATERIALS OR COMPONENTS SOLD BUT NOT MANUFACTURED BY GRACO. These items sold, but not manufactured by Graco (such as electric motors, switches, hose, etc.), are subject to the warranty, if any, of their manufacturer. Graco will provide purchaser with reasonable assistance in making any claim for breach of these warranties.

In no event will Graco be liable for indirect, incidental, special or consequential damages resulting from Graco supplying equipment hereunder, or the furnishing, performance, or use of any products or other goods sold hereto, whether due to a breach of contract, breach of warranty, the negligence of Graco, or otherwise.

FOR GRACO CANADA CUSTOMERS

The Parties acknowledge that they have required that the present document, as well as all documents, notices and legal proceedings entered into, given or instituted pursuant hereto or relating directly or indirectly hereto, be drawn up in English. Les parties reconnaissent avoir convenu que la rédaction du présente document sera en Anglais, ainsi que tous documents, avis et procédures judiciaires exécutés, donnés ou intentés, à la suite de ou en rapport, directement ou indirectement, avec les procédures concernées.

Graco Information

Sealant and Adhesive Dispensing Equipment

For the latest information about Graco products, visit www.graco.com.

For patent information, see www.graco.com/patents.

TO PLACE AN ORDER, contact your Graco distributor, go to www.graco.com, or call to identify the nearest distributor.

If calling from the USA: 1-800-746-1334

If calling from outside the USA: 0-1-330-966-3000

All written and visual data contained in this document reflects the latest product information available at the time of publication. Graco reserves the right to make changes at any time without notice.

Original instructions. This manual contains English. MM 3A8735

Graco Headquarters: Minneapolis

International Offices: Belgium, China, Japan, Korea

GRACO INC. AND SUBSIDIARIES • P.O. BOX 1441 • MINNEAPOLIS MN 55440-1441 • USA
Copyright 2022, Graco Inc. All Graco manufacturing locations are registered to ISO 9001.

www.graco.com
Revision A, April 2022