

LDP5 (Preset) Electronic Metered Dispense Valves

312668ZAC

EN

For metered dispense of oils and antifreeze only. Do not dispense windshield washer solvent. For professional use only.

Not approved for use in European explosive atmosphere locations.

Model

1000 psi (6.9 MPa, 69 bar) Maximum Working Pressure

See page 3 for model information.



Important Safety Instructions

Read all warnings and instructions in this manual before using the equipment.
Save these instructions.

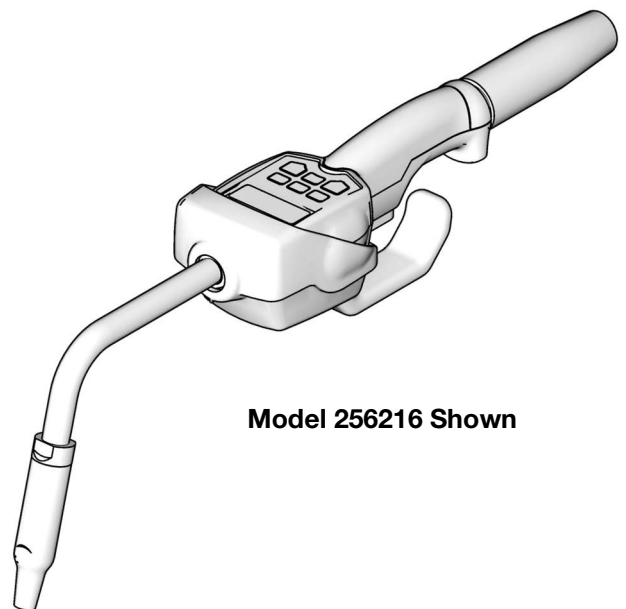

Model 256216 Shown

Contents

Models	3	Parts	25
Warnings	4	Kits and Accessories	27
Typical Installation	6	EM5/PM5 Upgrade Kits.....	27
Mounting Bracket.....	6	Nozzle Extension Accessory Kits.....	27
Installation	7	Thermal Relief Kits.....	27
Grounding.....	7	Technical Specifications	28
Pre-Installation Procedure.....	7	California Proposition 65	29
Installation Procedure.....	7	Graco Standard Warranty	30
Flush the System.....	7		
Electronic Control (1) and Gasket (2)			
Installation.....	8		
Kits: 257350 and 257351.....	8		
Connect Hose to Meter.....	8		
Install Extension and Nozzle to Meter.....	8		
Operation	10		
Pressure Relief Procedure.....	10		
LDP5 Meter Setup.....	10		
Locking and Unlocking the Trigger.....	10		
Terms.....	11		
Keypad Buttons.....	11		
Setup Menus.....	12		
Resettable Total.....	12		
Units of Measurement.....	13		
Calibration.....	14		
Auto Preset Amount.....	14		
Shut Off Default Amount.....	15		
LDP5 Meter Operation.....	16		
Dispensing Fluid in Manual Mode.....	16		
Dispensing Fluid in Auto Mode.....	17		
Viewing Totals.....	18		
Resettable Totals.....	18		
Non-Resettable Totals.....	19		
Error Codes.....	19		
Maintenance	21		
Replace the Battery.....	21		
Replace the Nozzle.....	21		
Security Seal.....	21		
Replace the Filter.....	21		
Recycling and Disposal	22		
End of Product Life.....	22		
Troubleshooting	23		

Models

Meter	Model No.	Extension		Impact Guard	Swivel Cover	Inlet		
		Rigid	Flex			NPT	BSPT	BSPP
LDP5	255277		X			X		
LDP5	256216	X		X	X	X		
LDP5	258694		X	X	X	X		
LDP5	24F883		X				X	
LDP5	24F884	X		X	X		X	
LDP5	24F886		X	X	X		X	
LDP5	24F889		X					X
LDP5	24F890	X		X	X			X
LDP5	24F892		X	X	X			X
LDP5	24X465			X	X			X
LDP5	26D917	X		X	X	X		

Warnings

The following warnings are for the setup, use, grounding, maintenance, and repair of this equipment. The exclamation point symbol alerts you to a general warning and the hazard symbols refer to procedure-specific risks. When these symbols appear in the body of this manual or on warning labels, refer back to these Warnings. Product-specific hazard symbols and warnings not covered in this section may appear throughout the body of this manual where applicable.

WARNING

	<p>SKIN INJECTION HAZARD</p> <p>High-pressure fluid from dispensing device, hose leaks, or ruptured components will pierce skin. This may look like just a cut, but it is a serious injury that can result in amputation. Get immediate surgical treatment.</p> <ul style="list-style-type: none"> • Do not point dispensing device at anyone or at any part of the body. • Do not put your hand over the fluid outlet. • Do not stop or deflect leaks with your hand, body, glove, or rag. • Follow the Pressure Relief Procedure when you stop dispensing and before cleaning, checking, or servicing equipment. • Tighten all fluid connections before operating the equipment. • Check hoses and couplings daily. Replace worn or damaged parts immediately.
---	---

	<p>EQUIPMENT MISUSE HAZARD</p> <p>Misuse can cause death or serious injury.</p> <ul style="list-style-type: none"> • Do not operate the unit when fatigued or under the influence of drugs or alcohol. • Do not exceed the maximum working pressure or temperature rating of the lowest rated system component. See Technical Specifications in all equipment manuals. • Use fluids and solvents that are compatible with equipment wetted parts. See Technical Specifications in all equipment manuals. Read fluid and solvent manufacturer's warnings. For complete information about your material, request Safety Data Sheets (SDSs) from distributor or retailer. • Turn off all equipment and follow the Pressure Relief Procedure when equipment is not in use. • Check equipment daily. Repair or replace worn or damaged parts immediately with genuine manufacturer's replacement parts only. • Do not alter or modify equipment. Alterations or modifications may void agency approvals and create safety hazards. • Make sure all equipment is rated and approved for the environment in which you are using it. • Use equipment only for its intended purpose. Call your distributor for information. • Route hoses and cables away from traffic areas, sharp edges, moving parts, and hot surfaces. • Do not kink or over bend hoses or use hoses to pull equipment. • Keep children and animals away from work area. • Comply with all applicable safety regulations.
--	--

WARNING



FIRE AND EXPLOSION HAZARD

When flammable fluids are present in the work area, such as gasoline and windshield wiper fluid, be aware that flammable fumes can ignite or explode. To help prevent fire and explosion:



- Use equipment only in well-ventilated area.
- Eliminate all ignition sources, such as cigarettes and portable electric lamps.
- Ground all equipment in the work area.
- Keep work area free of debris, including rags and spilled or open containers of solvent and gasoline.
- Do not plug or unplug power cords or turn lights on or off when flammable fumes are present.
- Use only grounded hoses.
- **Stop operation immediately** if static sparking occurs or you feel a shock. Do not use equipment until you identify and correct the problem.
- Keep a working fire extinguisher in the work area.



PERSONAL PROTECTIVE EQUIPMENT

Wear appropriate protective equipment when in the work area to help prevent serious injury, including eye injury, hearing loss, inhalation of toxic fumes, and burns. Protective equipment includes but is not limited to:

- Protective eyewear, and hearing protection.
- Respirators, protective clothing, and gloves as recommended by the fluid and solvent manufacturer.

Typical Installation

The installation shown in FIG. 1 is only a guide for selecting and installing system components. Contact your Graco distributor for assistance in planning a system.

Dispense valves can also be installed on a console as shown in FIG. 2.

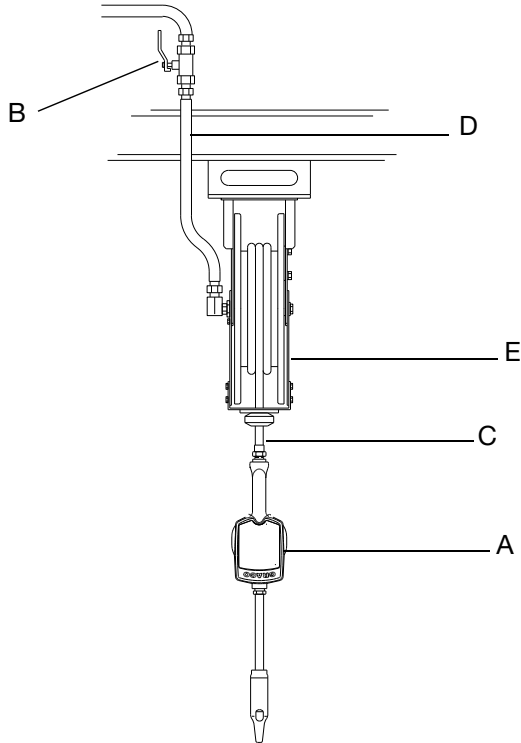

FIG. 1

Key:

- A Metered dispense valve
- B Fluid shut-off valve
- C Hose
- D Hose reel fluid inlet hose
- E Hose reel

A Thermal Relief Kit (not shown) is required. The kit will vary depending upon the pump. See **Kits and Accessories**, page 27 for available kits.

NOTICE	
<ul style="list-style-type: none">• Do not use this dispense valve on non-Graco consoles. The trigger could be inadvertently pressed while the dispense valve is stowed.• This dispense valve is not designed for in-line installation. Do not install with a shut off valve on the outlet side of the meter to avoid damaging the meter housing cover.	

Mounting Bracket

Mounting bracket (P/N 196471) is available for resting dispense valve on the console (FIG. 2).

NOTICE	
<p>Do not obstruct the dispense valve trigger or and do not set the unit down resting on the trigger, or the dispense valve may not stop dispensing.</p>	

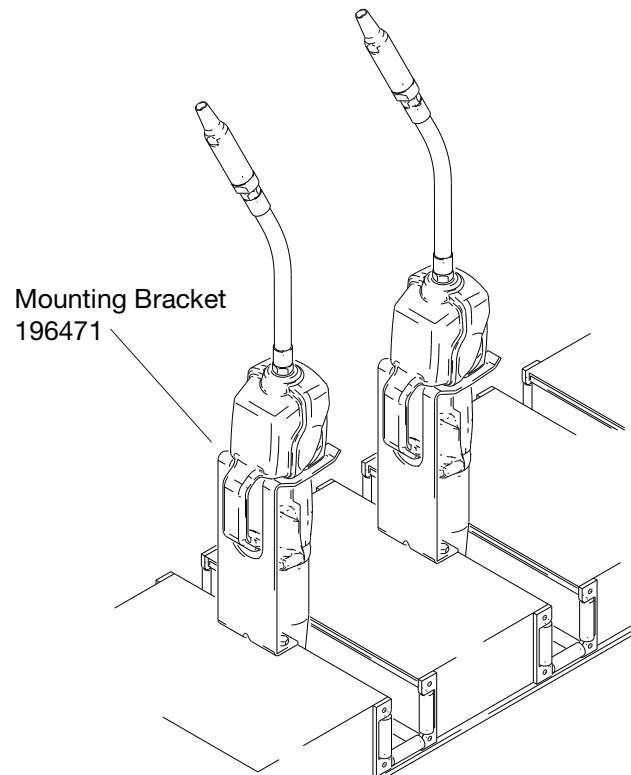

FIG. 2

Installation

This dispense valve must be calibrated after installation (beginning on page 14). Dispense amounts vary with fluid pressure, temperature, and type of fluid dispensed.

This dispense valve is designed for indoor use only, for use with industrial grade batteries (see page 21), and is not designed for in-line installation.

Grounding



The equipment must be grounded to reduce the risk of static sparking. Static sparking can cause fumes to ignite or explode. Grounding provides an escape wire for the electric current.

Pump: follow the manufacturer's recommendations.

Hose Reels or consoles: connect to a true earth ground.

Fluid hoses: use only conductive hoses when dispensing petroleum products.

To maintain grounding continuity when flushing or relieving pressure, hold a metal part of the valve firmly to the side of a grounded metal pail, then trigger the valve.

Pre-Installation Procedure

1. Install the battery. See **Replace the Battery**, page 21.
2. Follow the **Pressure Relief Procedure**, page 10.
3. Close the shut off valve (B) (FIG. 1, page 6).
4. Ground the hose and reel or counsel. See **Grounding**.

NOTE: Leave at least two engaged threads bare when using PTFE tape, the bare threads ensure ground is maintained.

Installation Procedure

NOTICE

For new installations, or when there is contaminated fluid in the lines, flush the lines before installing the meter valve, to avoid valve leakage.

For existing installations, skip to **Electronic Control (1) and Gasket (2) Installation**, page 8.

Flush the System

1. Close the fluid shut off valve (B) at each dispense position (FIG. 3).
2. Make sure that the main fluid outlet valve at the pump is closed.
3. Adjust the air pressure to the pump motor.
 - a. Adjust the air regulator attached to the motor air inlet.
 - b. Open the air valve.
 - c. Slowly open the main fluid valve.
4. Flush the system:
 - a. Place the hose end (no dispense valve connected) into a container for waste oil.
 - b. Secure the hose in the container so it does not come out during flushing.
 - c. For multiple dispense positions, start with the dispense position furthest from the pump, and work toward the pump.
5. Slowly open the shut off valve (B) at the dispense position and flush out a sufficient amount of oil to ensure that the entire system is clean (FIG. 3).
6. Close the shut off valve (B) (FIG. 3).
7. Repeat steps 5 and 6 at all of the dispense positions.

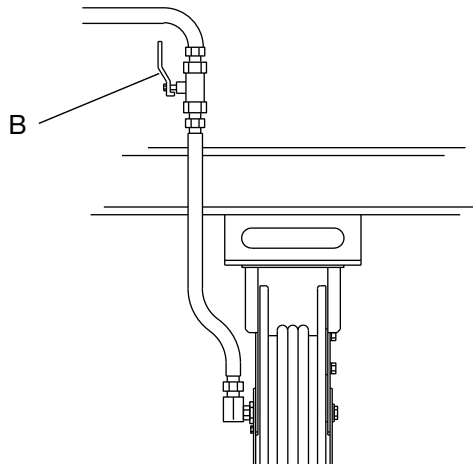

FIG. 3

Electronic Control (1) and Gasket (2) Installation

Kits: 257350 and 257351

It is important to properly seat the gasket (2) when installing electronic controls (1) to the fluid section (FIG. 4)

An improperly seated gasket could cause the meter to report invalid dispense amounts because the glass reed switches are broken.

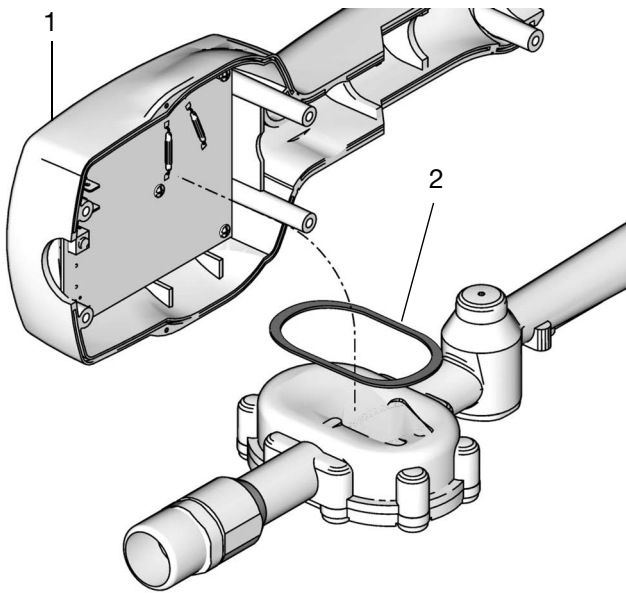

FIG. 4

Connect Hose to Meter

1. Follow the **Pressure Relief Procedure**, page 10.
2. Slide the swivel cover (34) onto the hose, small end first, before connecting the hose fitting to the swivel (4) (FIG. 5).
3. Apply thread sealant to the male threads of the hose fitting.
4. Thread the hose fitting into the swivel (4) and tighten firmly (FIG. 5).

NOTE: Make sure to let the sealant cure according to the manufacturer recommendation before allowing fluid into the system.

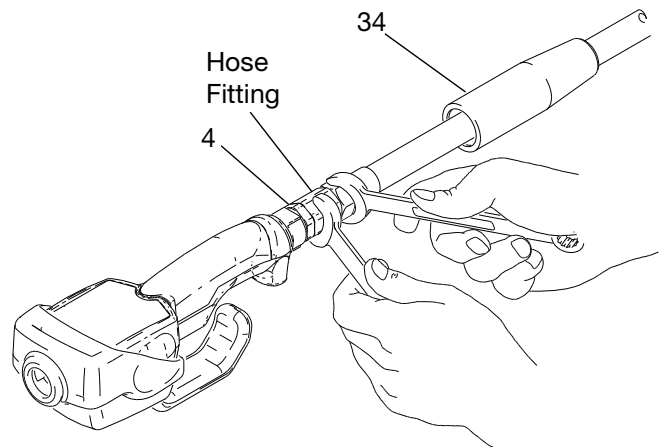

FIG. 5

Install Extension and Nozzle to Meter

1. Thread the sealing nut (26c) into the extension (26a) (FIG. 6).
2. Thread extension into meter outlet at least three full turns to tighten securely (FIG. 6).

NOTICE
<ul style="list-style-type: none"> • Do not over tighten the extension to sealing nut. Over tightening may cause the meter casting to split. • Do not use a twist/lock or manual shut off nozzle. An automatic nozzle must be used on the meter or the meter could be damaged.

3. Thread the new nozzle (26b) onto the extension using an open-end, adjustable wrench and tighten firmly.

NOTE: Tighten the nozzle with the wrench only on the flats of the nozzle bushing. Do not disassemble the bushing from the nozzle, it will affect the performance of the nozzle.

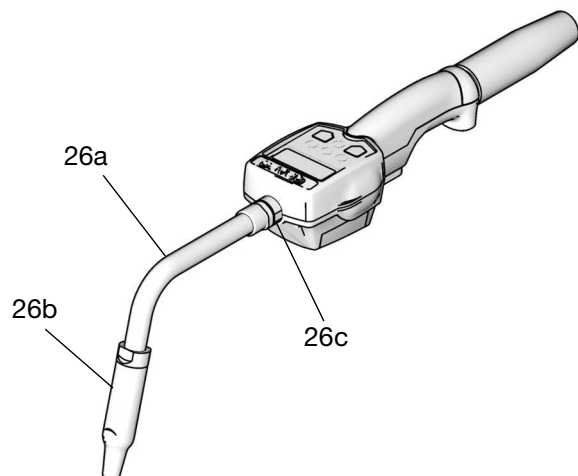

FIG. 6

4. Open all of the dispense position shut off valves (B) and start the pump to pressurize the system. See **LDP5 Meter Operation**, page 16 for proper operation of the meter (FIG. 7).
- To ensure dispensing accuracy, purge all of the air from the fluid lines and dispense valve before use.
 - Set the system to flow at the desired flow rate, typically 1.5 gpm (5.7 l/m). Do not exceed a 5 gpm (18.9 l/m) flow rate.

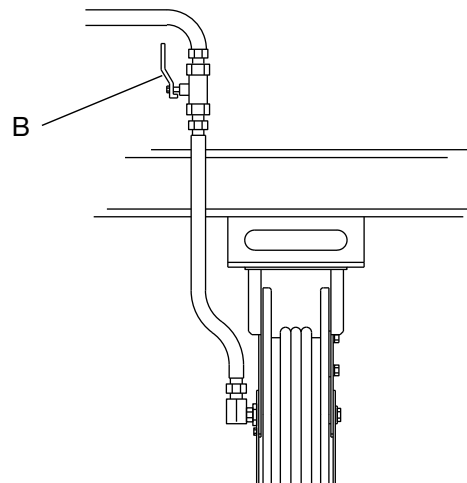

FIG. 7

Operation

Pressure Relief Procedure



Follow the Pressure Relief Procedure whenever you see this symbol.



This equipment stays pressurized until pressure is manually relieved. To help prevent serious injury from pressurized fluid, such as skin injection, and splashing fluids, follow the Pressure Relief Procedure when you stop dispensing and before cleaning, checking, or servicing the equipment.

1. Turn off power supply to the pump.
2. Trigger the dispense valve into a grounded waste container to relieve pressure.
3. Open any bleed-type master air valves and fluid drain valves in the system.
4. Leave the drain valve open until ready to pressurize the system.

LDP5 Meter Setup

Locking and Unlocking the Trigger

To lock the trigger (FIG. 8), press on the part of the trigger that has the textured grip until it clicks into the locked position.

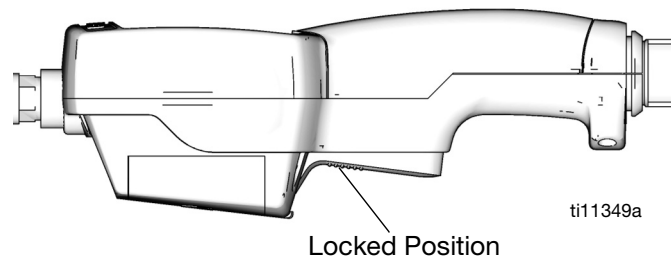

FIG. 8

To unlock the trigger (FIG. 9), press on the smooth part of the trigger until it clicks out of the locked position. When the trigger is released, the fluid flow stops.

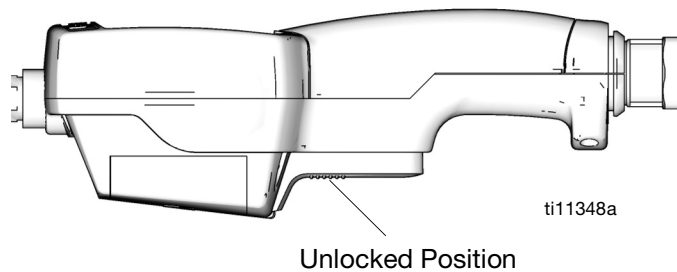

FIG. 9

In Auto mode, the unit stops dispensing when the entered amount has been dispensed.

In Manual mode, the trigger does not automatically unlock; it must be unlocked manually.

Terms

The following terms are shown on the display or used in this instruction manual.

- R-TOTAL: Resettable Total**
Shows the cumulative amount dispensed in all modes. Can be reset to zero.
- TOTAL: Non-resettable Total**
Shows the cumulative amount dispensed in all modes for the life of the unit. Can not be reset.
- Manual Mode**
Dispense mode display counts up from zero to show the dispensed amount. In this mode, the trigger may be locked, but it must be manually unlocked when the desired amount is dispensed. Memory setting also unlocks the trigger.
- Auto Mode**
Dispense mode dispenses a preset, user-entered amount. When the preset amount is dispensed, the trigger unlocks to stop the unit from dispensing, and the amount dispensed is displayed. Further dispensing is allowed by pulling back the trigger, and the display resumes counting.
- Asleep / Awake Mode**
Asleep is a battery-saving mode where the display goes blank after 45 seconds of inactivity. The display comes Awake when any button is pressed or when the trigger is squeezed to dispense fluid.

Keypad Buttons

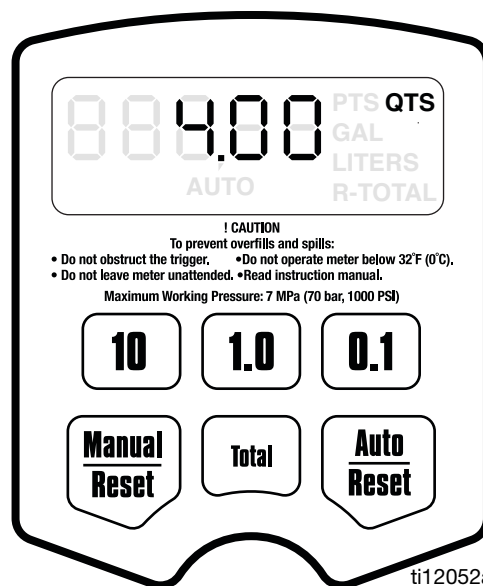
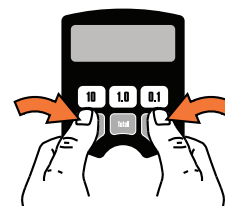

FIG. 10

- Manual / Reset***
Use to select Manual Mode dispensing. The first push selects the mode, and the second push resets the display to zero.
- Auto / Reset***
Use to select Auto Mode dispensing. The first push selects the mode, and the second push resets the display to zero.

* Press Manual / Reset and Auto / Reset buttons simultaneously to display the Setup Menu (page 12).



- Total**
Use in any mode to see the resettable total and the non-resettable total.
- 10, 1.0, and 0.1**
Use in Auto Mode and during setup to enter dispense amounts.

NOTE: All buttons are disabled while fluid is being dispensed.

Setup Menus

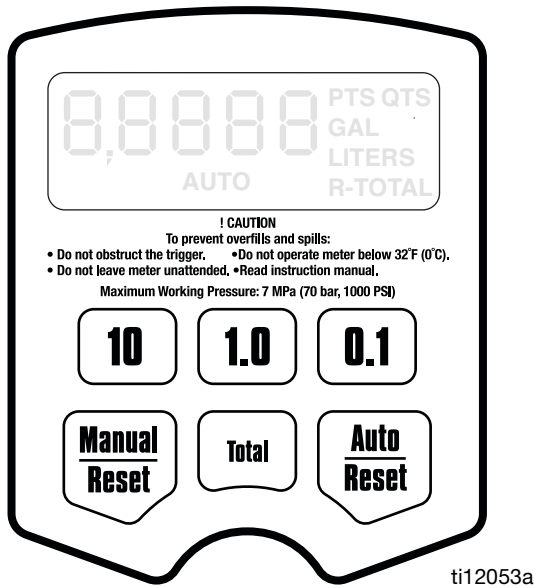
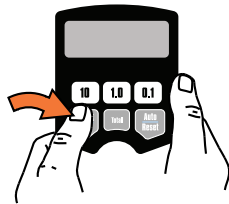
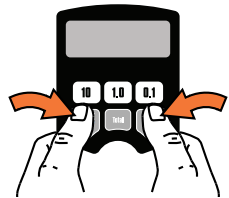

FIG. 11

1. If the display is blank (Asleep), wake it by pressing any button on the keypad.



2. Press and hold the Manual/Reset and Auto/Reset buttons simultaneously for approximately six (6) seconds to enter the Setup Menus.



NOTE: During the first four (4) seconds, all segments display. Then for two (2) seconds, the software version number displays.

3. There are five (5) Setup Menu screens available, stored in a preset order. Press and hold the Auto / Reset button to move through the menu screens.
 - a. First screen: Resettable Total Menu (FIG. 12, page 12) - R-TOTAL (G) blinks in the lower right corner on the screen.

- b. Second screen: Units of Measure Menu (FIG. 13, page 13) - the last set Unit of Measurement blinks in the lower right corner on the screen.

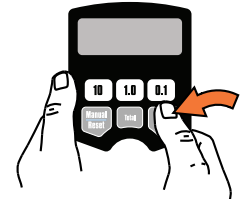

- c. Third screen: Calibration Menu (FIG. 14, page 14) - CAL blinks on the screen.
- d. Fourth screen: Auto Preset Amount Menu (FIG. 15, page 14) - AUTO blinks and the currently stored auto preset amount displays.
- e. Fifth screen: Shut Off Default Amount Menu (FIG. 16, page 15) - the clock icon blinks and the stored shut off default amount displays.

The value displayed when leaving each menu is the value that is stored.

Resettable Total

Resets the dispense total to zero or stores the displayed dispense total. The resettable total accumulates until the next time it is manually reset.

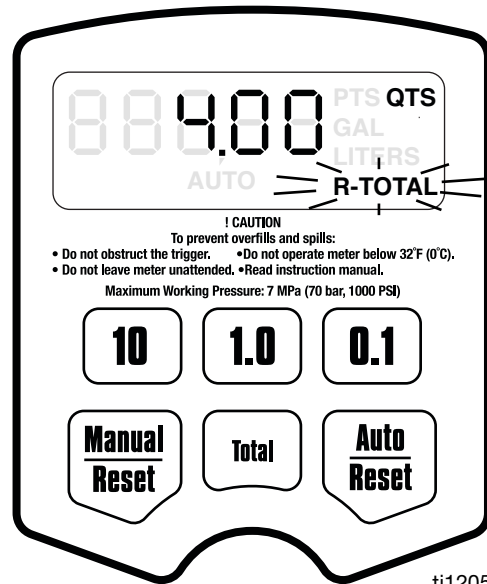
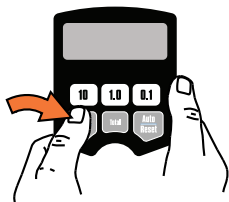

FIG. 12

1. If the Resettable Total screen is not already displayed, complete steps 1 - 3 in the **Setup Menus**, page 12.
2. R-TOTAL blinks indicating that the Resettable Total Menu screen is displayed. The currently stored total and unit of measurement display.

3. Do one of the following:

- a. Press and hold the Manual / Reset button to reset the total to zero (0).



- b. Press and hold the Auto / Reset button to store the zero (0) measurement unit. The Units of Measurement Menu displays.

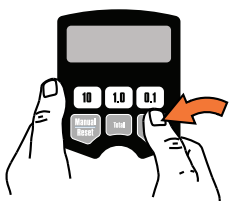

or

- Press and hold the Auto / Reset button to store the currently displayed total. The Units of Measurement Menu displays.

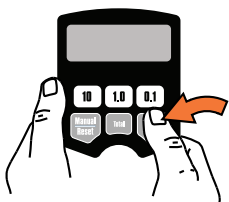

Units of Measurement

Sets the units of measurement to gallons, quarts, pints, or liters.

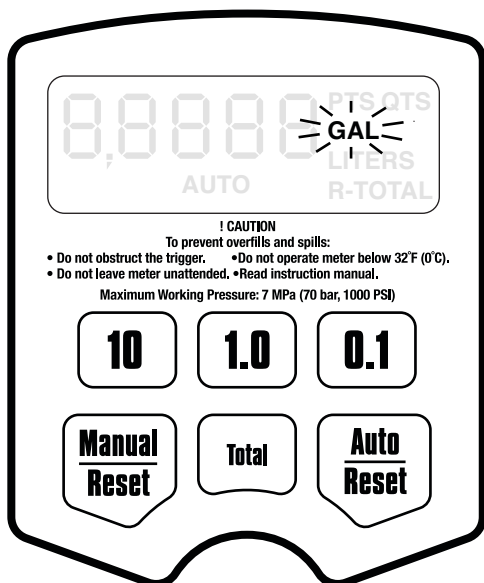

ti12055a

FIG. 13

- 1. If the Units of Measurement Menu is not already displayed, complete steps 1- 3 in **Setup Menu**, page 12.

- 2. GAL, QTS, PTS or LITERS blinks indicating the Units of Measurement Menu screen is displayed.

3. Do one of the following:

- a. Press and hold Manual / Reset button to display next unit of measurement in sequence. Each time the button is pressed and held, the next unit of measurement displays.

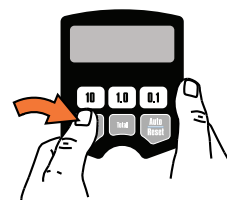

- b. When desired measurement unit is displayed, press and hold Auto / Reset button to lock in new measurement unit. Calibration Menu displays.

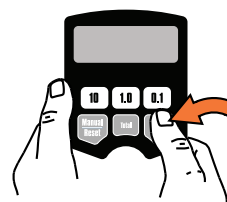

or

- Press and hold the Auto / Reset button. The currently displayed measurement unit is stored. Calibration Menu displays.

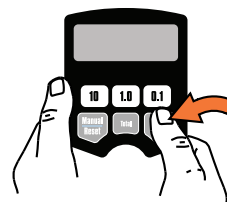

Calibration

Recalibrate the meter for dispensing different fluids.

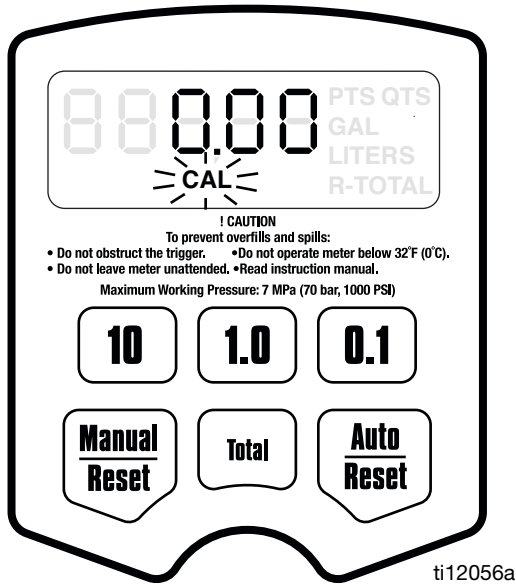

ti12056a

FIG. 14

1. If the Calibration Screen is not already displayed, complete steps 1 - 3 of the **Setup Menus**, page 12.
2. CAL blinks indicating the Calibration Menu screen.
3. Do one of the following:

Use the current calibration.

- Press and hold the Auto / Reset button to lock in the displayed amount. The display advances to the Auto Preset Amount Menu.

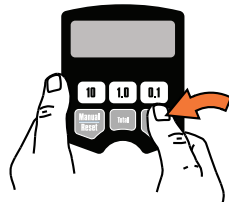

or

Recalibrate the meter:

- a. If the unit of measurement is gallons, pints, or quarts, dispense exactly one (1) quart of fluid into a calibrated one (1) quart container.

If the unit of measurement is liters, dispense exactly one (1) liter of fluid into a calibrated one (1) liter container.

For proper calibration, the exact amount must be dispensed.

- b. Press and hold the Manual / Reset button until CAL stops blinking.

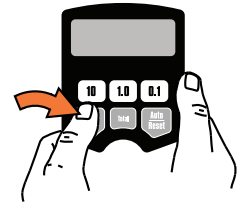

- c. When CAL starts to blink again, the display should show 1.00, which indicates the new calibration is complete.

NOTE: If an error was made during meter recalibration, repeat steps a - c of the recalibration process.

- d. Press and hold the Auto / Reset button to advance to the Auto Preset Amount Menu.

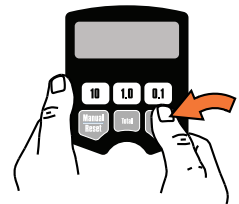

Auto Preset Amount

Specifies an amount displayed when in Auto Dispense Mode. Typically, enter the amount most frequently dispensed.

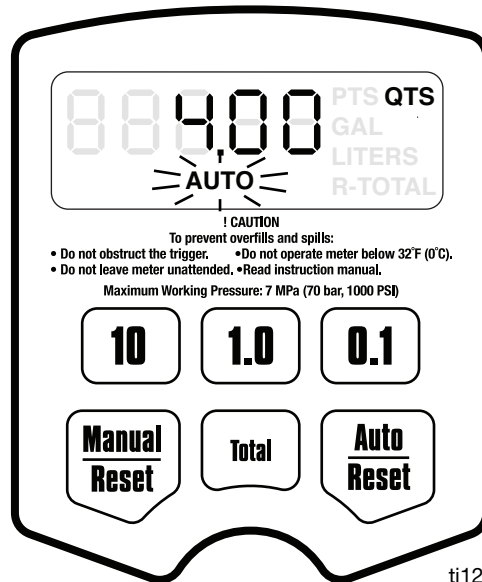

ti12082a

FIG. 15

1. If the Auto Preset Amount screen is not already displayed, complete steps 1 - 3 of the **Setup Menus**, page 12.

2. AUTO blinks indicating the Auto Preset Amount Menu. The currently stored auto preset amount is displayed. (This is the amount displayed when the Auto / Reset button is pressed during normal operation.)

3. Do one of the following:

a. To enter a new auto preset amount, press and hold the 10 button to change the 10's digit,

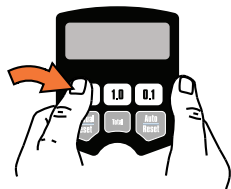

the 1.0 button to change the 1's digit,



and the 0.1 button to change the first decimal digit. Zero cannot be entered.

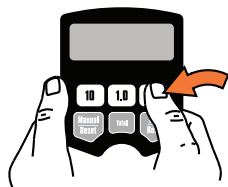

NOTE: to reset the display to 0.00, press and hold the Manual / Reset button.

b. Press and hold the Auto / Reset button to lock in the amount. The Shut Off Default Amount Menu displays.

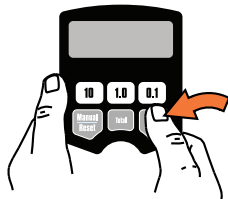

OR

- Press and hold the Auto / Reset button to lock in the currently displayed auto preset amount. The display advances to the Shut-Off Default Amount Menu.

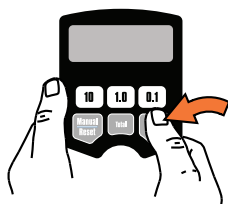

Shut Off Default Amount

Prevents accidental overfills when dispensing with the trigger locked in Manual mode. The shut off default amount is factory preset at 5 quarts.

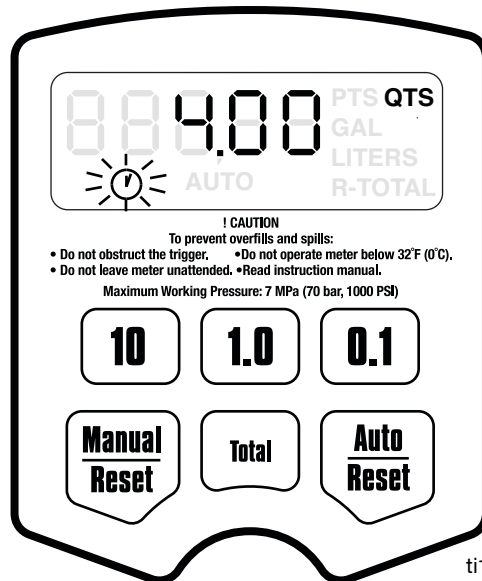

ti12058a

Fig. 16

- If the Shut Off Default Amount Menu is not already displayed, complete steps 1 - 3 of the **Setup Menus**, page 12.
- The clock icon blinks indicating the Shut Off Default Amount Menu is displayed. The stored shut off default amount is displayed.

Operation

3. Do one of the following:

- a. To enter a new shut off default amount, press and hold the 10 button to change the 10's digit,

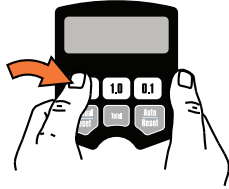

the 1.0 button to change the 1's digit,



and the 0.1 button to change the first decimal digit. Zero cannot be entered.

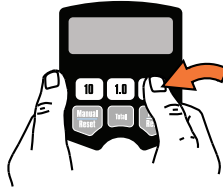

NOTE: To reset the display to 0.00, press and hold the Manual / Reset button.

- b. Press and hold the Auto / Reset button to lock in the new shut off default amount and return to the unit to the Manual Dispense Mode.



or

- Press and hold the Auto/Reset button to return to the unit to the Manual Dispense Mode.

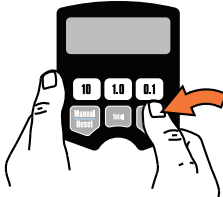

LDP5 Meter Operation

Dispensing Fluid in Manual Mode

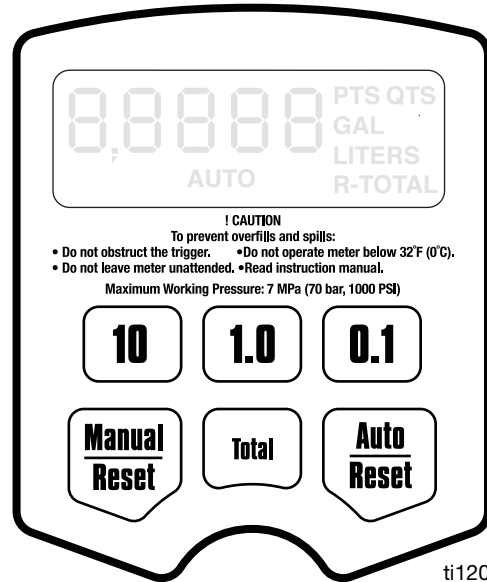

ti12053a

FIG. 17

1. Press and hold the Manual/Reset button.

- If the display is blank (Asleep), it wakes up and displays the amount displayed before it fell asleep.
- If the display is awake, and the meter is in Manual Dispense Mode, the display clears to 0.00.
- If the display is awake, and the unit is in Viewing Totals mode or Auto Dispense Mode, the meter switches to the Manual Dispense Mode.

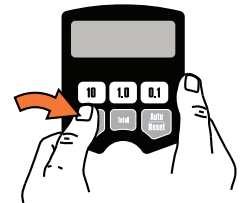

2. When the display is awake, it can dispense from zero or from the displayed amount by doing one of the following:

- Press and hold the Manual/Reset button again to clear the display to 0.00 if it is not already at 0.00. Then go to step 3.

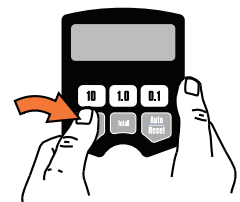

or

- Go to step 3 to dispense from the displayed amount.

- Squeeze the trigger. It may be locked. See **Locking and Unlocking the Trigger**, page 10.

Fluid flows, and the amount displayed counts up from zero or the previously dispensed amount.

- Release/unlock the trigger when you have dispensed the desired amount of fluid.

Fluid flow stops. The amount you have dispensed is displayed.

You may press and hold the Manual/Reset button again to reset the displayed amount to zero.

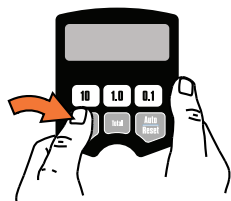

NOTE: When the trigger is released, the automatic nozzle prevents the fluid in the extension from running out.

Dispensing Fluid in Auto Mode

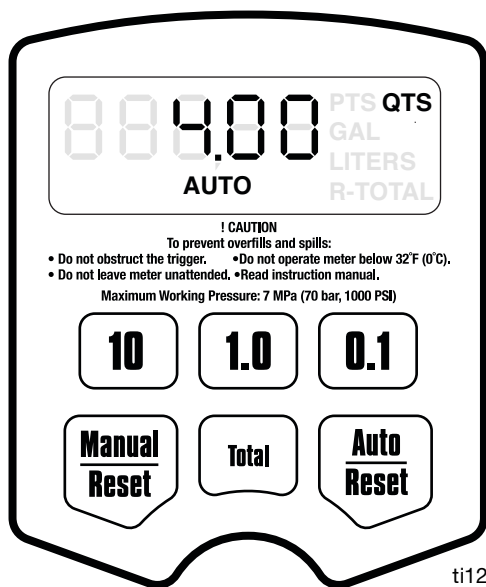

ti12057a

FIG. 18

NOTICE

Before beginning a preset dispense cycle, make sure that AUTO is displayed. If AUTO is not on the display, it is not in Auto dispense mode, and fluid flow will not stop when the auto preset amount is dispensed.

- Press and hold the Auto/Reset button.

The display wakes up if it was asleep, and AUTO and the stored preset dispense amount are displayed. The factory default is 5.00.

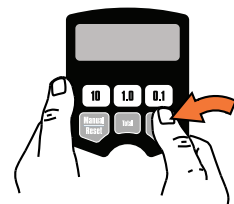

NOTE: To change the stored preset dispense amount, see **Auto Preset Amount**, page 14.

- Dispensing or changing the displayed preset amount is done by one of the following:

- Go straight to step 3 to dispense the displayed preset amount.

or

- To change the displayed preset amount:

- Press and hold the Auto/Reset button to set the display to zero.

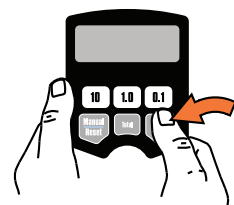

- Press the 10 button to change the 10's digit.

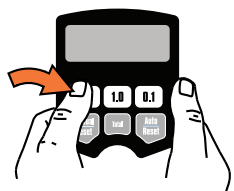

press the 1.0 button to change the 1's digit.



and the 0.1 button to change the first decimal digit. Zero cannot be entered.

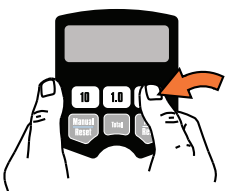

NOTE: to reset the display to 0.00, press and hold the Manual / Reset button.

3. Lock the trigger. See **Locking and Unlocking the Trigger**, page 10.

Fluid flows, and the displayed dispensed amount counts up from zero. When the preset amount is dispensed, the trigger unlocks, fluid flow stops, the dispensed amount is displayed, and the meter switches to the Manual Dispense Mode.

To stop fluid flow before the preset amount is dispensed, manually unlock the trigger. To continue the dispense, lock the trigger, and the dispensed amount resumes counting toward the preset amount.

To continue dispensing after the trigger unlocks at the preset dispense amount, squeeze the trigger, and the dispensed amount resumes counting until the trigger is released.

NOTE: When the trigger unlocks, the automatic nozzle prevents the fluid in the extension from running out.

Viewing Totals

To view the non-resettable and resettable totals follow these instruction. To change the resettable total, see **Resettable Total**, page 12.

1. If the display is blank (Asleep), press and hold the Manual/Reset or Auto/Reset button to wake it up.

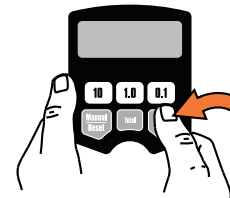

2. Press and hold the Total button to view the resettable total amount (FIG. 19).

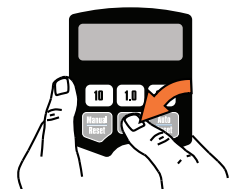

Resettable Totals

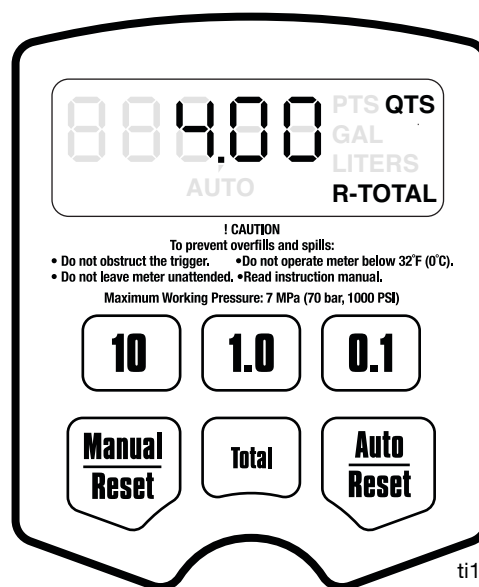

ti12059a

FIG. 19

3. Press and hold the Total button again to view the non-resettable, grand total amount.

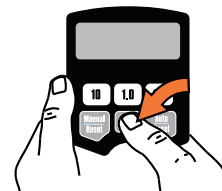

If the unit of measurement is gallons, quarts, or pints, the resettable total is displayed in gallons, (FIG. 19). If the unit of measurement is liters, the resettable total is displayed in liters.

Pressing and holding the Total button toggles between the non-resettable and resettable total.

4. Press and hold the Manual/Reset or Auto/Reset button to return to Manual or Auto Dispensing Mode.

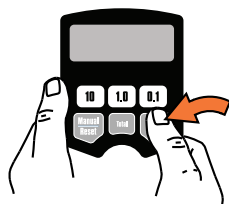

Non-Resettable Totals

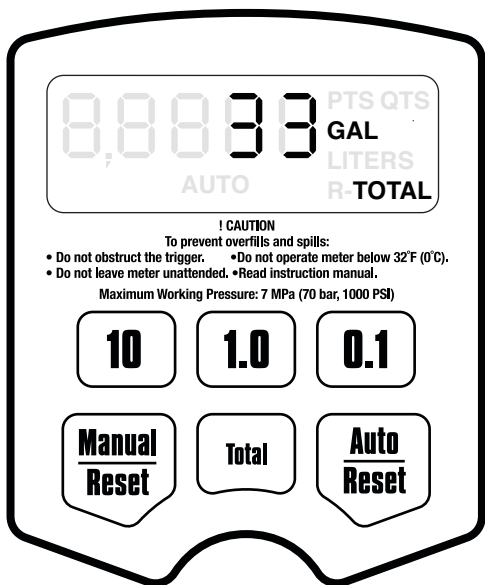

ti12060a

FIG. 20

Error Codes

Error codes are listed in the table. Even in an error condition, the unit tracks the amount dispensed. Options with any error code displayed, as shown at right:

- Press the Manual/Reset button. The error code is cleared, the unit switches to Manual mode, and the dispensed amount is displayed.
- Press the Auto/Reset button. The error code is cleared, the unit switches to Auto mode, and the preset amount is displayed.

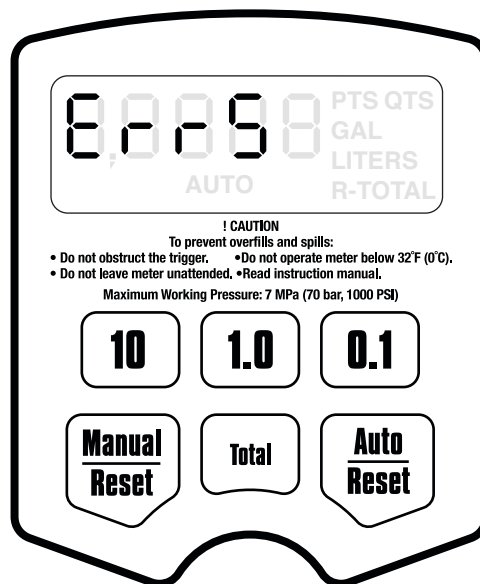
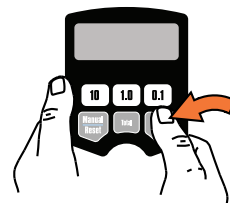
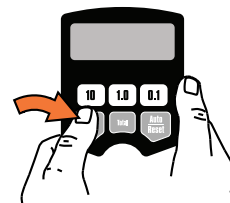

ti12061a

FIG. 21

Error Code	Cause	Solution
Err 1	<p>Flow rate is higher than 5 gpm.</p> <p>Air was pumped through the line.</p>	<p>Adjust the flow rate so it is not higher than 5 gpm.</p> <p>Purge air from the line.</p>
Err 4	<p>Flow has continued after it should have shut off.</p>	<p>Check if unit is resting on the trigger if an obstruction is pressing the trigger. The unit checks for flow every second and repeats the error code until the trigger is released and the error code cleared.</p>
Err 5	<p>The unit has dispensed the shut off default amount and has stopped fluid flow.</p>	<p>Press the Manual/Reset button, and dispense again. To change the shut off default amount, see Shut Off Default Amount, page 15.</p>
Err 6	<p>A preset dispense amount of zero was entered for the dispense or is stored as the default, and a Preset dispense was attempted.</p>	<p>Enter an amount that is not zero. See Dispensing Fluid in Auto Mode, page 17.</p>

Maintenance

Replace the Battery



Only replace the battery in a non-hazardous location, away from flammable fluids or fumes. Battery required to meet safety protocols:

- Duracell® alkaline MN1604, PC1604

NOTE: Do not change the battery while anything is shown on the display. Wait until the unit falls asleep and the display is blank before removing the battery. If the battery is removed while something is shown on the display, that information will be lost from memory.

To change the battery, remove the battery cover, and replace the old battery with a new battery (FIG. 22).

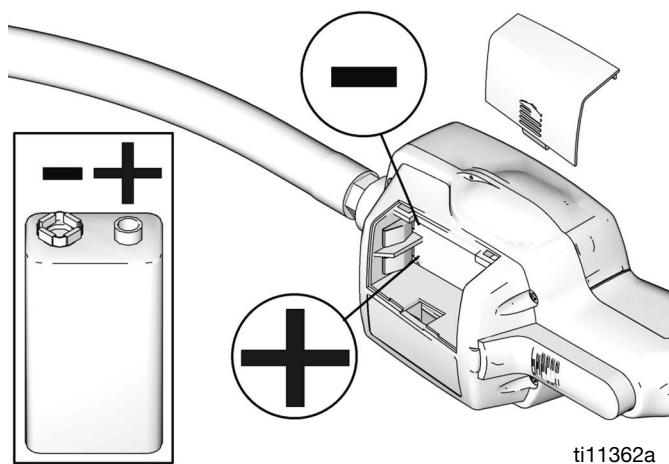

FIG. 22

Replace the Nozzle

If the nozzle begins to leak, replace it. Refer to **Install Extension and Nozzle to Meter**, page 8.

Security Seal

The security seal prevents access to the inside of the meter and tampering with the meter settings. See FIG. 23.

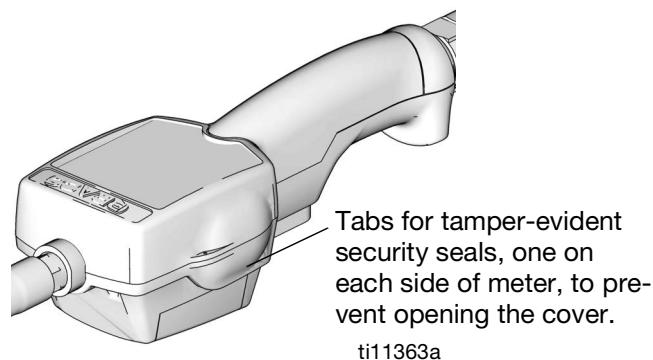

FIG. 23

Replace the Filter

1. Follow the **Pressure Relief Procedure**, page 10.
2. Unscrew the hose from the swivel (4) (FIG. 24).
3. Remove the o-ring (8b) and the filter (8a) from inside of the swivel (4) with an o-ring pick (FIG. 24).
4. Push the new filter (8a) into the swivel (4), and make sure it is properly seated (FIG. 24).
5. Replace the o-ring (8b) (FIG. 24).
6. Thread the hose back into the swivel (4) (FIG. 24).

NOTE: Orient the new filter (8a) so the concave side of the screen faces downstream, as shown in FIG. 24.

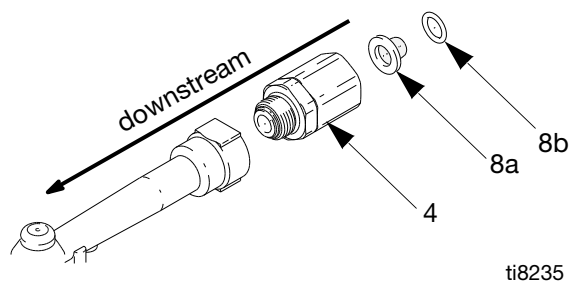

FIG. 24

Recycling and Disposal

End of Product Life

At the end of the product's useful life, dismantle and recycle it in a responsible manner.

- Perform the **Pressure Relief Procedure**. page 10.
- Drain and dispose of fluids according to applicable regulations. Refer to the material manufacturer's Safety Data Sheet.
- Remove motors, batteries, circuit boards, LCDs (liquid crystal displays), and other electronic components. Recycle according to applicable regulations.
- Do not dispose of batteries or electronic components with household or commercial waste.



- Deliver remaining product to a recycling facility.

Troubleshooting



1. Follow **Pressure Relief Procedure**, page 10, before checking or repairing the dispense valve.
2. Check all possible problems and causes before disassembling.

Problem	Cause	Solution
Battery icon is displayed.	Battery is low.	Replace the battery. See Replace the Battery , page 21.
Battery icon is blinking, and bAtt (BATT) is blinking.	Battery is dead or is not suited for this application (poor quality).	Replace the battery. See Replace the Battery , page 21.
Display does not activate or is showing unintelligible character.	Battery is defective or dead.	Replace the battery. See Replace the Battery , page 21.
	Electronic control is malfunctioning.	Replace the electronic control (clam-shell).
	A dispense mode has not been selected.	Select a dispense mode by pressing the Manual/Reset button or the Auto/Reset button.
Slow or no fluid flow	Filter is clogged.	1. Relieve pressure by following the Pressure Relief Procedure , page 10. 2. Clean or replace the filter. See Replace the Filter , page 21. 3. If the problem remains, contact your Graco distributor for repair or replacement.
	Pump pressure is low.	Turn up pump pressure.
	Shut-off valve is not fully open.	Fully open shut-off valve.
	Foreign material is jammed in the meter housing.	Contact your Graco distributor for repair or replacement.
Displayed dispensed amount is not accurate.	Unit needs to be calibrated for the fluid that is being dispensed.	Calibrate the meter for the fluid that is being dispensed. See Calibration , page 14.
Oil leaks from where fluid outlet tube connects to housing.	Outlet tube or sealing nut or street elbow is loose or damaged.	Check outlet tube, sealing nut, and street elbow for looseness or damage and tighten or replace.
	Sealing nut is oriented the wrong way.	Make sure the PTFE seal on the sealing nut is facing the surface against which it is tightened.

Problem	Cause	Solution
Meter leaks from Cover/Control	Poor swivel (3)/hose connection.	Apply PTFE tape (leave minimum 2 engaged threads uncovered for electrical continuity) or sealant to threads of hose and tighten the connection. See Connect Hose to Meter , page 8.
	Poor swivel (3)/meter housing connection.	Torque the fitting to 20-25 ft-lb (27 to 34 N•m).
	Damaged valve stem assembly.	Replace or clean valve stem and O-rings. Order Valve Repair Kit 240453.
	Poor seal at meter housing plate. NOTE: Place a straight edge along the meter housing plate. If flat, the plate, and seal are okay. If the plate is not flat, the meter is damaged.	Contact your Graco distributor for repairs or replacement.
Meter leaks from Automatic nozzle NOTE: It is important to distinguish between the two causes of this problem. A new nozzle will not correct a fluid leak caused by a faulty valve.	Automatic nozzle has a damaged seal.	Replace the nozzle. See Replace the Nozzle , page 21.
	Valve has damaged or obstructed seals.	Replace or clean valve stem and o-rings. Order Valve Repair Kit 240453.
Unit does not stop dispensing when assumed auto amount is dispensed.	Auto amount was not entered correctly.	Enter a preset dispense amount in the Auto dispense mode. AUTO must be displayed below the amount.

Parts

Models 256216, 24F884,
24F890, 26D917
26: Rigid Extension
Kit: 239949

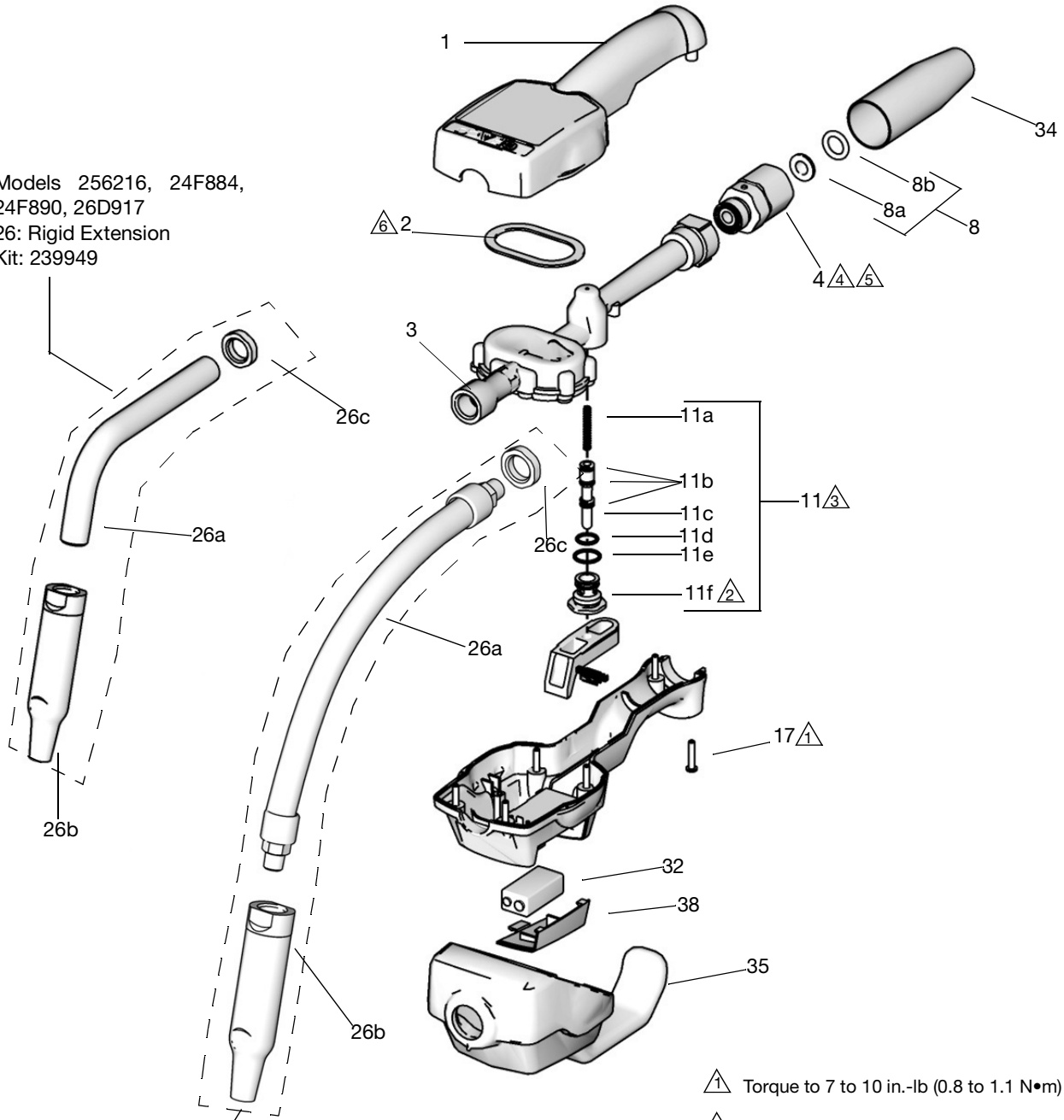

26: Flexible Extension
Kit: 239951
Models 255277, 258694, 24F886, 24F892
255277, 24F883, 24F889

- ⚠️ Torque to 7 to 10 in.-lb (0.8 to 1.1 N•m)
- ⚠️ Torque to 140 to 150 in.-lb (16 to 17 N•m)
- ⚠️ Apply lubricant when reassembling
- ⚠️ Torque to 20 to 25 ft.-lb (27 to 34 N•m)
- ⚠️ Apply thread sealant when assembling
- ⚠️ Housing surface (3) must be clean to ensure proper adhesive bonding of gasket (2)

Parts

Ref.	Part	Description	Qty.
1	257351	CONTROL, electronic, LDP5, includes 15M845	1
2	15T124	GASKET, bumper	1
3*		HOUSING, meter	
4	240416	SWIVEL, straight, 1/2-14 NPT	1
	24G805	SWIVEL, straight, 1/2-14 BSPT	1
	24G806	SWIVEL, straight, 1/2-14 BSPP	1
8	255884	KIT, filter, 80 mesh, includes 8a and 8b	1
8a		STRAINER, filter	10
8b		PACKING, o-ring	10
11	240453	KIT, repair, valve, includes 11a - 11f and 1 each, 8a and 8b.	1
11a		SPRING, compression	1
11b		PACKING, o-ring, valve	3
11c		STEM, valve	1
11d		PACKING, o-ring	1
11e		PACKING, o-ring	1
11f		SEAT, valve	1
17	113412	SCREW, mach, torx pan head	6
18	191046	TRIGGER	1
26	239951	KIT, nozzle, flexible, extension for oil and anti-freeze, includes 26a - 26c (models 255751, 255277, 258693, 258694, 2F881, 24F883, 24F885, 24F886, 24F887, 24F889, 24F891, 24F892)	1
26a		EXTENSION	1
26b		NOZZLE, dispenser	1
26c	113419	NUT, sealing	1
29		LABEL, information (not shown)	1
32	113716	BATTERY, 9-volt (models 255277, 256216, 258694, 24F883, 24F884, 24F886, 24F889, 24F890, 24F892, 24X465)	1
	(none)	(model 26D917)	
34	191294	COVER, swivel, black (models 256216, 258694, 24F884, 24F886, 26D917)	1
	130986	BOOT, black, BSPP (models 24F890, 24F892, 24X465)	1
	191287	red (optional)	
	191288	blue (optional)	
	191289	green (optional)	
	191295	yellow (optional)	
35	247759	GUARD, impact, black (models 256215, 256216, 258693, 258694, 24F882, 24F884, 24F885, 24F886, 24F888, 24F890, 24F891, 24F892)	1
	247760	yellow (optional)	
	243835	red (optional)	
	243836	blue (optional)	
	243837	green (optional)	
38	15M845	COVER, battery	1

*Not a purchase part. Shown for reference only.

▲ Replacement safety labels, tags, and cards are available at no cost.

Kits and Accessories

EM5/PM5 Upgrade Kits*

Part	Description
257350	EM5 to LDM5
257351	PM5 to LDP5

*Includes 15T124

Nozzle Extension Accessory Kits

Ref. 26

Part No.	Description	Lubricant Type
238371	Nozzle (b) only	Gear Lube
239829	Nozzle (b) only	Oil and Antifreeze
238887	Rigid, includes extension (a), nozzle (b), and fitting (c)	Gear Lube
239951	Flexible, includes extension (a), nozzle (b), and fitting (c)	Oil and Antifreeze

Thermal Relief Kits

Part No.	Description	PSI (MPa, bar)
112353	Diaphragm pump for fuel dispense, valve only	50 psi (0.34 MPa, 3.4 bar)
235998	Mini Fire-Ball™ 225, 3:1	600 psi (4.1 MPa, 41 bar)
237601	Fire-Ball 425, 3:1	600 psi (4.1 MPa, 41 bar)
237893	Fire-Ball 300, 5:1 and Fire-Ball 425, 6:1	900 psi (6.2 MPa, 62 bar)
248296	Fire-Ball 300, 5:1 and Fire-Ball 425, 6:1 (same as 237893 minus bung adapter and swivel. Includes 6-foot hose)	900 psi (6.2 MPa, 62 bar)
238899	Diaphragm pump	150 psi (1.03 MPa, 10.3 bar)
240429	Fire-Ball 425, 10:1	1600 psi (11.0 MPa, 110 bar)
248324	Fire-Ball 425, 10:1 (same as 240429 minus bung adapter and swivel. Includes 6-foot hose)	1600 psi (11.0 MPa, 110 bar)

Technical Specifications

LDP5 (Preset) Electronic Metered Dispense Valves		
	US	Metric
Flow range*	0.1 to 5 gpm	0.4 to 19 lpm
Maximum Working Pressure	1000 psi	6.89 MPa, 68.9 bar
Operating temperature range	55°F to 120°F	12.8°C to 49°C
Storage temperature range	-30°F to 120°F	-34°C to 49°C
Inlet/Outlet Sizes		
Inlet size	1/2 npt, 1/2 bspp, 1/2 bspt	
Outlet size	3/8 npt	
Fluid Compatibility	lubricating oils, antifreeze mixtures	
Dimensions without extension/nozzle		
Length	11 in.	28 cm
Width	3.25 in.	8.3 cm
Height	3.25 in.	8.3 cm
Wetted parts		
Wetted parts	Stainless steel, nitrile rubber, zinc, CS, LCP	
Battery**	9 volt alkaline	
Pressure loss at 5 gpm†	90 psi	0.62 MPa, 6.2 bar
Accuracy	+/- 0.5 percent	
Units of Measurement (pints, quarts, gallons, liters (factory set to quarts))		
Maximum totalizer amount	99,999 units	
Maximum recorded dispensed volume	999.99 units	
Maximum preset volume	999.9 units	
Weight		
All models	3 lb.	1.36 kg
Notes		
<p>*Tested in No. 10W motor oil. Flow rates vary with fluid pressure, temperature, and viscosity.</p> <p>**Battery required to meet safety approvals: Duracel® MN1604</p> <p>†At 2.5 gpm (9.5 lpm), at 70°F (21°C), with 10W motor oil and 1 gal. (3.8 l) dispensed. May require calibration; out of box accuracy is +/- 1.25 percent.</p> <p>Duracel® is a registered trademark of Duracell Inc.</p> <p>All other brand names or marks are used for identification purposes are trademarks of their respective owners.</p>		

California Proposition 65

CALIFORNIA RESIDENTS

 **WARNING:** Cancer and reproductive harm – www.P65warnings.ca.gov.

Graco Standard Warranty

Graco warrants all equipment referenced in this document which is manufactured by Graco and bearing its name to be free from defects in material and workmanship on the date of sale to the original purchaser for use. With the exception of any special, extended, or limited warranty published by Graco, Graco will, for a period of twelve months from the date of sale, repair or replace any part of the equipment determined by Graco to be defective. This warranty applies only when the equipment is installed, operated and maintained in accordance with Graco's written recommendations.

This warranty does not cover, and Graco shall not be liable for general wear and tear, or any malfunction, damage or wear caused by faulty installation, misapplication, abrasion, corrosion, inadequate or improper maintenance, negligence, accident, tampering, or substitution of non-Graco component parts. Nor shall Graco be liable for malfunction, damage or wear caused by the incompatibility of Graco equipment with structures, accessories, equipment or materials not supplied by Graco, or the improper design, manufacture, installation, operation or maintenance of structures, accessories, equipment or materials not supplied by Graco.

This warranty is conditioned upon the prepaid return of the equipment claimed to be defective to an authorized Graco distributor for verification of the claimed defect. If the claimed defect is verified, Graco will repair or replace free of charge any defective parts. The equipment will be returned to the original purchaser transportation prepaid. If inspection of the equipment does not disclose any defect in material or workmanship, repairs will be made at a reasonable charge, which charges may include the costs of parts, labor, and transportation.

THIS WARRANTY IS EXCLUSIVE, AND IS IN LIEU OF ANY OTHER WARRANTIES, EXPRESS OR IMPLIED, INCLUDING BUT NOT LIMITED TO WARRANTY OF MERCHANTABILITY OR WARRANTY OF FITNESS FOR A PARTICULAR PURPOSE.

Graco's sole obligation and buyer's sole remedy for any breach of warranty shall be as set forth above. The buyer agrees that no other remedy (including, but not limited to, incidental or consequential damages for lost profits, lost sales, injury to person or property, or any other incidental or consequential loss) shall be available. Any action for breach of warranty must be brought within two (2) years of the date of sale.

GRACO MAKES NO WARRANTY, AND DISCLAIMS ALL IMPLIED WARRANTIES OF MERCHANTABILITY AND FITNESS FOR A PARTICULAR PURPOSE, IN CONNECTION WITH ACCESSORIES, EQUIPMENT, MATERIALS OR COMPONENTS SOLD BUT NOT MANUFACTURED BY GRACO. These items sold, but not manufactured by Graco (such as electric motors, switches, hose, etc.), are subject to the warranty, if any, of their manufacturer. Graco will provide purchaser with reasonable assistance in making any claim for breach of these warranties.

In no event will Graco be liable for indirect, incidental, special or consequential damages resulting from Graco supplying equipment hereunder, or the furnishing, performance, or use of any products or other goods sold hereto, whether due to a breach of contract, breach of warranty, the negligence of Graco, or otherwise.

FOR GRACO CANADA CUSTOMERS

The Parties acknowledge that they have required that the present document, as well as all documents, notices and legal proceedings entered into, given or instituted pursuant hereto or relating directly or indirectly hereto, be drawn up in English. Les parties reconnaissent avoir convenu que la rédaction du présente document sera en Anglais, ainsi que tous documents, avis et procédures judiciaires exécutés, donnés ou intentés, à la suite de ou en rapport, directement ou indirectement, avec les procédures concernées.

Graco Information

For the latest information about Graco products, visit www.graco.com.

For patent information, see www.graco.com/patents.

TO PLACE AN ORDER, contact your Graco distributor or call to identify the nearest distributor.

Phone: 612-623-6928 **or Toll Free:** 1-800-533-9655, **Fax:** 612-378-3590

All written and visual data contained in this document reflects the latest product information available at the time of publication. Graco reserves the right to make changes at any time without notice.

Original instructions. This manual contains English. MM 312688

Graco Headquarters: Minneapolis

International Offices: Belgium, China, Japan, Korea

GRACO INC. AND SUBSIDIARIES • P.O. BOX 1441 • MINNEAPOLIS MN 55440-1441 • USA
Copyright 2008 Graco Inc. All Graco manufacturing locations are registered to ISO 9001.

www.graco.com
Revision ZAC, September 2022